

## **PWM Control 2A Step-Down Converter**

### **❖ GENERAL DESCRIPTION**

AX3165/A consists of step-down switching regulator with PWM control. These device include a reference voltage source, oscillation circuit, error amplifier, internal PMOS and etc.

AX3165/A provides low-ripple power, high efficiency, and excellent transient characteristics. The PWM control circuit is able to the duty ratio linearly form 0 up to 100%. This converter is build out soft start function that prevents overshoot and inrush current at startup. An over current protect function and short circuit protect function are built inside, and when OCP or SCP happens, the operation frequency will be reduced. An external compensation is easily to system stable; the low ESR output capacitor can be used.

With the addition of an internal P-channel Power MOS, a coil, capacitors, and a diode connected externally, these ICs can function as step-down switching regulators. They serve as ideal power supply units for portable devices when coupled with the SOP-8L with exposed pad package, providing such outstanding features as low current consumption. Since this converter can accommodate an input voltage up to 55V, it is also suitable for the operation via an AC adapter.

### **❖ FEATURES**

- Input voltage : 11V to 55V
- Output voltage : 3.3V to 53V
- Duty ratio : 0% to 100% PWM control
- Enable and Soft-Start function
- Current Limit, Short Circuit Protect (SCP) and Thermal Shutdown protection
- Built-in internal SW P-channel MOS.
- RoHS and Halogen free compliance.

❖ **BLOCK DIAGRAM**

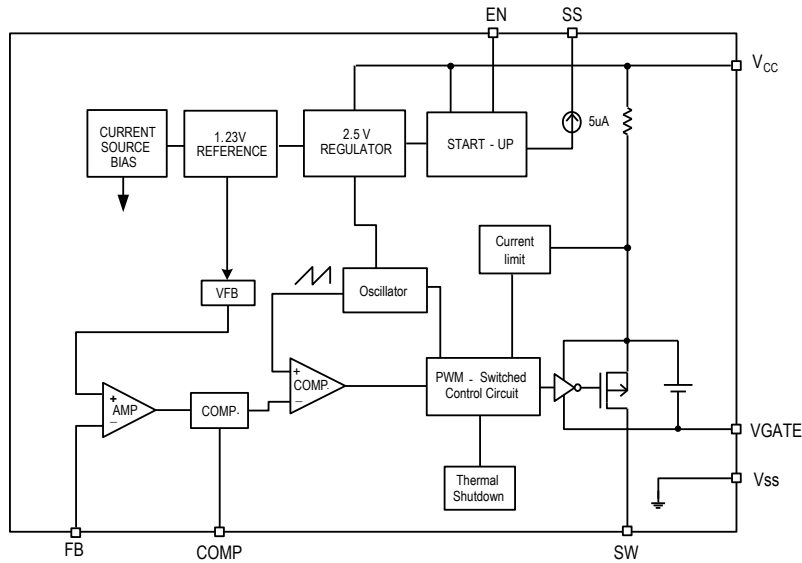

❖ **PIN ASSIGNMENT**

The package of AX3165/A is SOP-8L-EP; the pin assignment is given by:

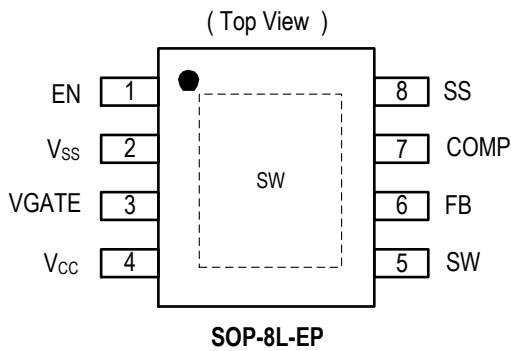

Name	Description
<b>EN</b>	ON/OFF Shutdown pin
<b>Vss</b>	GND pin
<b>VGATE</b>	Driver GATE clamping pin. The pin must connect a 1uF capacitor to VCC
<b>Vcc</b>	IC power supply pin
<b>SW</b>	Switch pin. Connect external inductor and diode here.
<b>FB</b>	Feedback pin
<b>COMP</b>	Compensation pin
<b>SS</b>	Soft-start pin

❖ **ORDER/MARKING INFORMATION**

Order Information	Top Marking
<p><b>AX3165 X XX X</b></p> <p>Frequency Blank : 120KHz A : 250KHz</p> <p>Package Type ES: SOP-8L-EP</p> <p>Packing Blank : Tube A : Taping</p>	<p>Logo ← <b>AX</b> 3 1 6 5 → Part number</p> <p>X Y Y W W X → ID code:internal</p> <p>Blank: AX3165 A: AX3165A</p> <p>WW: 01~52 Year: 10=2010 11=2011</p>

**❖ ABSOLUTE MAXIMUM RATINGS** (at  $T_A=25^{\circ}\text{C}$ )

Characteristics	Symbol	Rating	Unit
VCC Pin Voltage	$V_{CC}$	$V_{SS} - 0.3$ to $V_{SS} + 55$	V
Feedback Pin Voltage	$V_{FB}$	$V_{SS} - 0.3$ to 6	V
EN Pin Voltage	$V_{EN}$	$V_{SS} - 0.3$ to $V_{CC}$	V
SS Pin Voltage	SS	$V_{SS} - 0.3$ to 6	V
COMP Pin Voltage	$V_{COMP}$	$V_{SS} - 0.3$ to 6	V
VGATE Pin Voltage	$V_{GATE}$	$V_{SS} - 0.3$ to $V_{CC}$	V
Switch Pin Voltage	$V_{SW}$	$V_{SS} - 0.3$ to $V_{CC} + 0.3$	V
Power Dissipation	PD	Internally limited	mW
Storage Temperature Range	$T_{ST}$	-65 to +150	$^{\circ}\text{C}$
Operating Junction Temperature Range	$T_{OJP}$	-40 to +125	$^{\circ}\text{C}$
Operating Supply Voltage	$V_{OP}$	11 to 55	V
Thermal Resistance from Junction to case	$\theta_{JC}$	15	$^{\circ}\text{C/W}$
Thermal Resistance from Junction to ambient	$\theta_{JA}$	75	$^{\circ}\text{C/W}$

Note:  $\theta_{JA}$  is measured with the PCB copper area (need connect to Exposed Pad) of approximately 1.5 in<sup>2</sup> (Multi-layer).

**❖ ELECTRICAL CHARACTERISTICS**

( $V_{CC} = 24\text{V}$ ,  $T_A=25^{\circ}\text{C}$ , unless otherwise specified)

Characteristics	Symbol	Conditions	Min	Typ	Max	Units
Feedback Voltage	$V_{FB}$	$I_{OUT}=10\text{mA}$	0.98	1.00	1.02	V
Quiescent Current	$I_{CCQ}$	$V_{FB}=1.2\text{V}$ force driver off	-	3	6	mA
Feedback Bias Current	$I_{FB}$	$I_{OUT}=0.1\text{A}$	-	0.1	0.5	$\mu\text{A}$
Shutdown Supply Current	$I_{SD}$	$V_{EN}=0\text{V}$	-	0.5	1	mA
Line Regulation	$\Delta V_{OUT}/V_{OUT}$	$V_{CC}=10\text{V}\sim 55\text{V}$ , $I_{OUT}=10\text{mA}$	-	0.3	0.6	%
Load Regulation	$\Delta V_{OUT}/V_{OUT}$	$I_{OUT}=0.2$ to 2A	-	0.3	0.6	%
Current Limit	$I_{CL}$		2.8	-	-	A
Oscillator frequency	$F_{OSC}$	AX3165	90	120	150	KHz
	$F_{OSC}$	AX3165A	200	250	300	KHz
Short frequency	$F_{OSC1}$	AX3165 ICL	-	50	-	KHz
	$F_{OSC1}$	AX3165A ICL	-	110	-	KHz
	$F_{OSC2}$	AX3165/AX3165A $V_{FB} < 0.3$	-	30	-	KHz
EN Pin Logic input threshold voltage	$V_{SH}$	High (regulator ON)	2.0	-	-	V
	$V_{SL}$	Low (regulator OFF)	-	-	0.8	
EN Pin Input Current	$I_{SH}$	$V_{EN}=2.5\text{V}$ (ON)	-	5	-	$\mu\text{A}$
	$I_{SL}$	$V_{EN}=0.3\text{V}$ (OFF)	-	5	-	$\mu\text{A}$
SS Current	$I_{SS}$	$V_{SS}=0\text{V}$	-	10	-	$\mu\text{A}$
Internal MOSFET $R_{DS(ON)}$	$R_{DS(ON)}$	$V_{CC}=12\text{V}$ , 1A, $V_{FB}=0\text{V}$	-	220	300	m $\Omega$
Efficiency (AX3162)	EFFI	$V_{CC}=24\text{V}$ , $V_{OUT}=5\text{V}$ , $I_{OUT}=2\text{A}$	-	90	-	%
Thermal shutdown Temp	$T_{SD}$		-	150	-	$^{\circ}\text{C}$
Thermal Shutdown Hysteresis	$T_{SH}$		-	40	-	$^{\circ}\text{C}$



❖ **APPLICATION INFORMATION**

**Setting the Output Voltage**

Application circuit item shows the basic application circuit with adjustable output version. The external resistor sets the output voltage according to the following equation:

$$V_{OUT} = 1.0V \times \left(1 + \frac{R1}{R4}\right)$$

Table 1 Resistor select for output voltage setting

V <sub>OUT</sub>	R4	R1
5V	1.5K	6K
3.3V	1.3K	3K

**Inductor Selection**

For most designs, the different frequency can be reducing the inductor value; The AX3165/A is suggested 33μH. Where is inductor Ripple Current. Large value inductors lower ripple current and small value inductors result in high ripple currents. Choose inductor ripple current approximately 20% of the maximum load current 2A, Δ<sub>L</sub>=0.4A. The DC current rating of the inductor should be at least equal to the maximum load current plus half the ripple current to prevent core saturation (2A+0.2A).

**Input Capacitor Selection**

This capacitor should be located close to the IC using short leads and the voltage rating should be approximately 1.5 times the maximum input voltage. The RMS current rating requirement for the input capacitor of a buck regulator is approximately 1/2 the DC load current. A low ESR input capacitor sized for maximum RMS current must be used. A 470μF low ESR capacitor for most applications is sufficient.

**Output Capacitor Selection**

The output capacitor is required to filter the output and provide regulator loop stability. The important capacitor parameters are; the 100 KHz Equivalent Series Resistance (ESR), the RMS ripples current rating, voltage rating, and capacitance value. For the output capacitor, the ESR value is the most important parameter. The ESR can be calculated from the following formula.

$$V_{RIPPLE} = \Delta I_L \times ESR = 0.4A \times 80m\Omega = 32mV$$

An aluminum electrolytic capacitor's ESR value is related to the capacitance and its voltage rating. In most case, higher voltage electrolytic capacitors have lower ESR values. Most of the time, capacitors with much higher voltage ratings may be needed to provide the low ESR values required for low output ripple voltage. It is recommended to replace this low ESR capacitor by using a 470 $\mu$ F low ESR values < 80m $\Omega$ .

### PCB Layout Recommendations

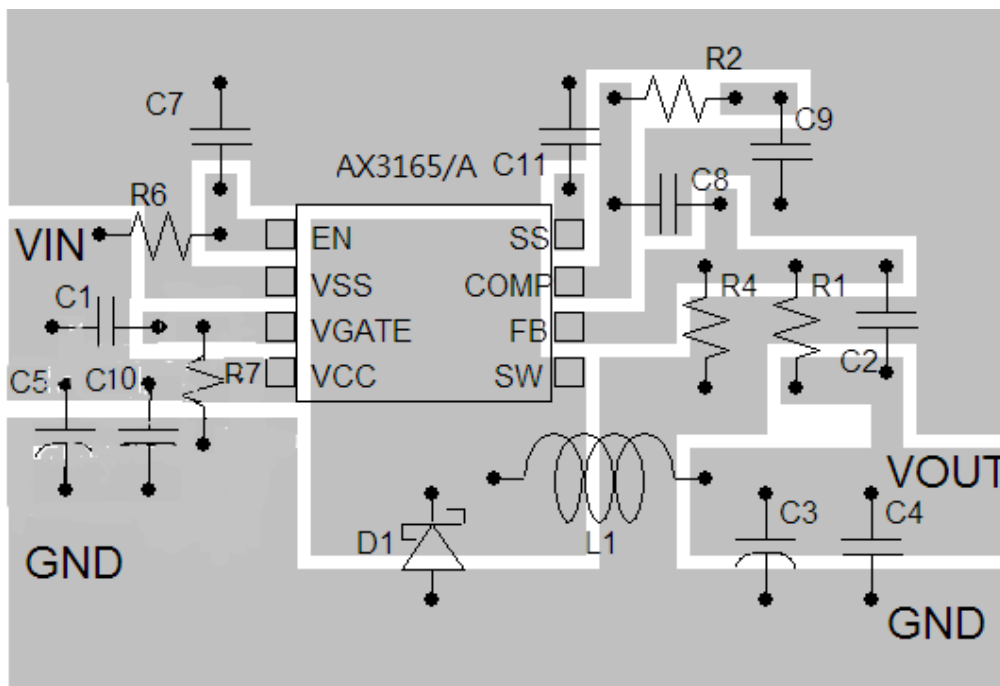

1. Connect the C5 & C10 VIN bypass capacitor next to the VCC pin with a short return to the VSS pin.
2. Keep the VGAE to VCC bypass capacitor C1 near both pins as it provides the internal P-ch MOSFET gate driver.
3. Keep the SW traces as short as is practically possible as these carry high peak currents to decrease the EMI issue.
4. Carefully connect the noise sensitive signals such as FB, COMP as close to the IC as practically possible.

❖ TYPICAL CHARACTERISTICS

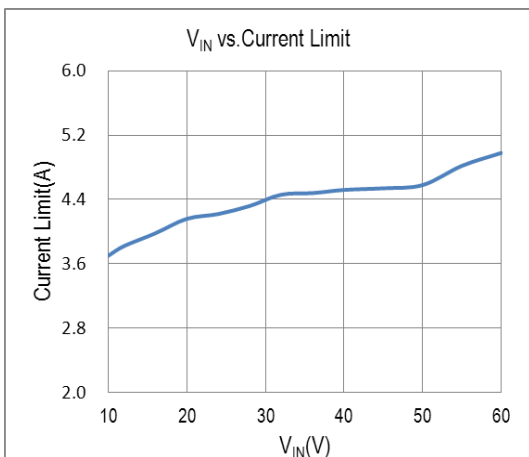
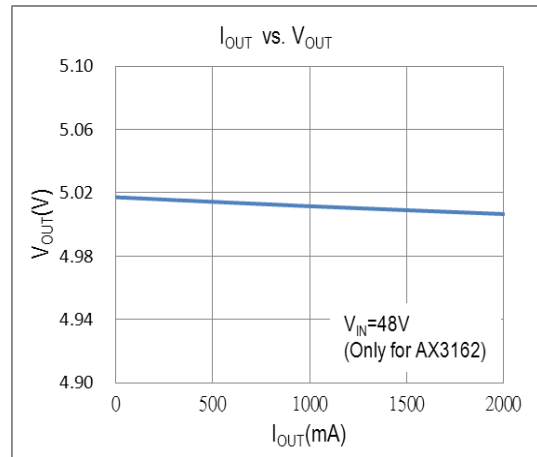
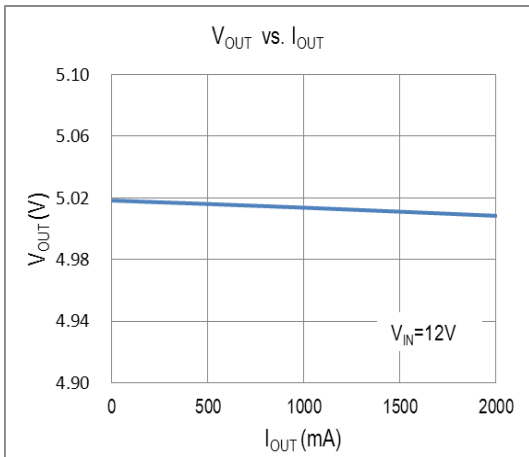
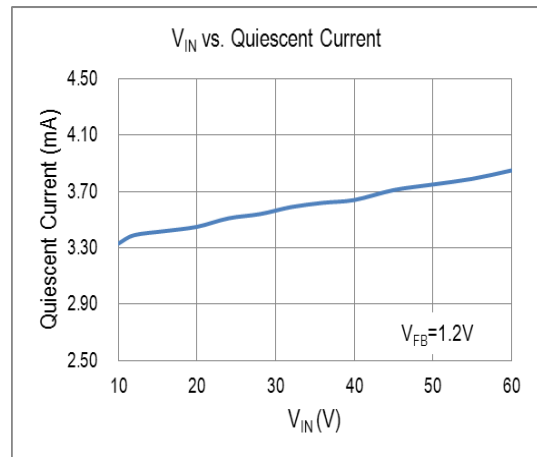
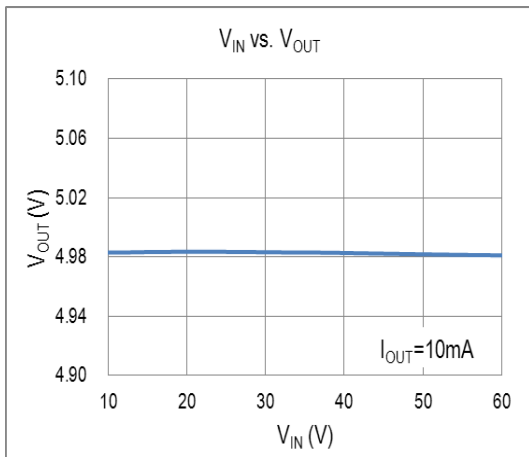

❖ TYPICAL CHARACTERISTICS (CONTINUOUS)

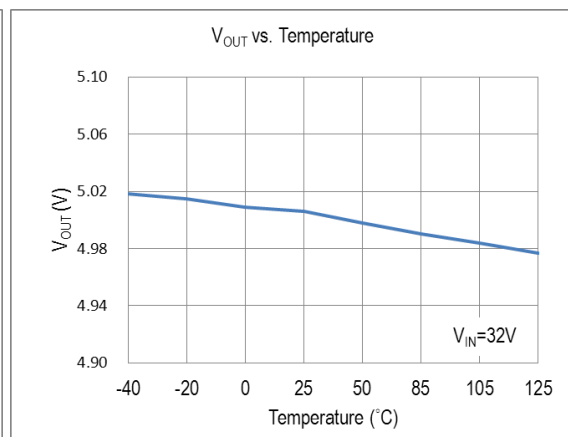
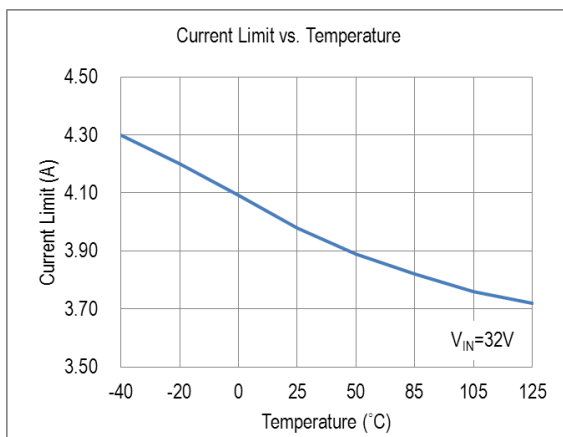
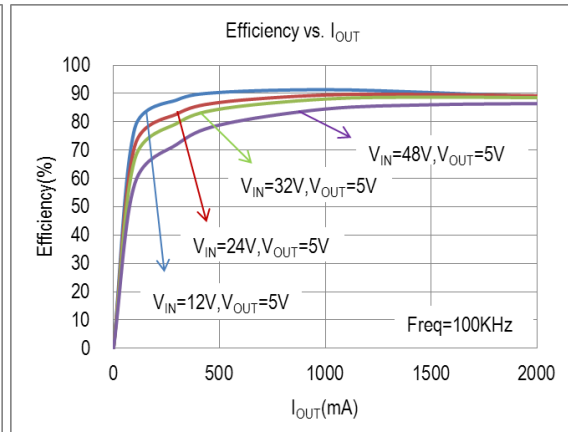
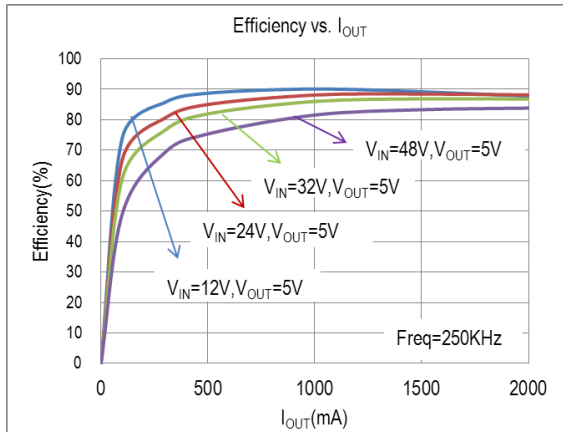



❖ PACKAGE OUTLINES

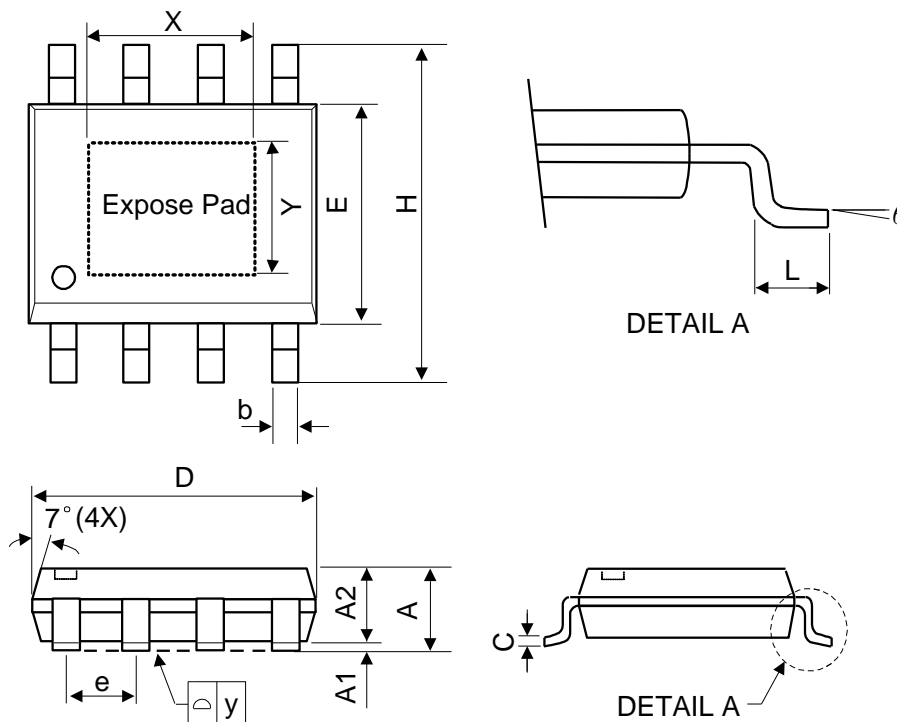

Symbol	Dimensions in Millimeters			Dimensions in Inches		
	Min.	Nom.	Max.	Min.	Nom.	Max.
A	-	-	1.75	-	-	0.069
A1	0	-	0.15	0	-	0.06
A2	1.25	-	-	0.049	-	-
C	0.1	0.2	0.25	0.0075	0.008	0.01
D	4.7	4.9	5.1	0.185	0.193	0.2
E	3.7	3.9	4.1	0.146	0.154	0.161
H	5.8	6	6.2	0.228	0.236	0.244
L	0.4	-	1.27	0.015	-	0.05
b	0.31	0.41	0.51	0.012	0.016	0.02
e	1.27 BSC			0.050 BSC		
y	-	-	0.1	-	-	0.004
X	-	2.34	-	-	0.092	-
Y	-	2.34	-	-	0.092	-
θ	0°	-	8°	0°	-	8°

Mold flash shall not exceed 0.25mm per side  
JEDEC outline: MS-012 BA

❖ CARRIER TAPE DIMENSION

SOP-8L-EP

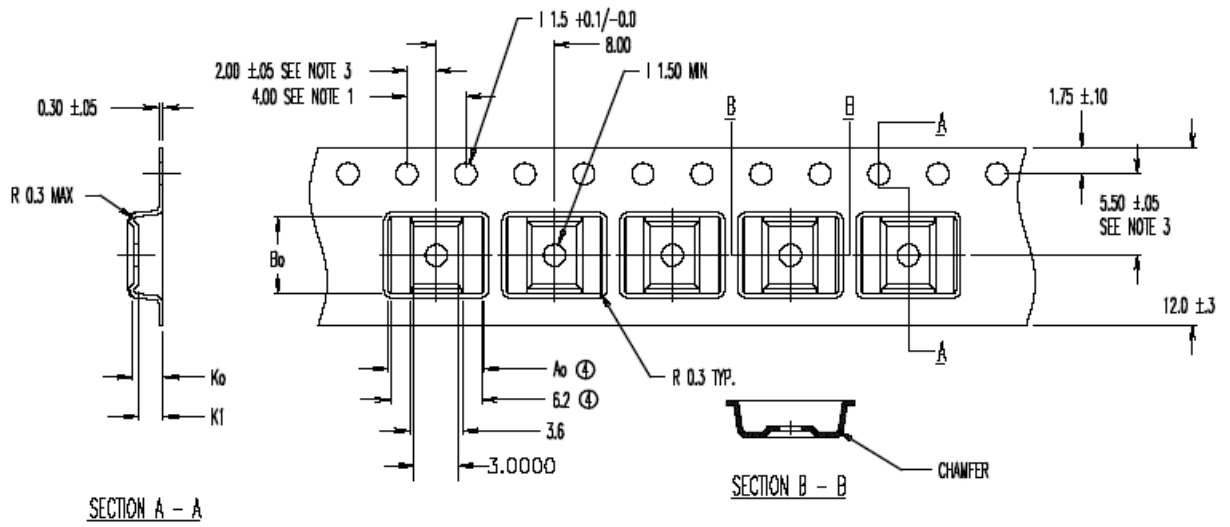

- ①  $A_0 = 6.50$
- $B_0 = 5.20$
- $K_0 = 2.10$
- $K_1 = 1.70$

