

N-CH40V Fast Switching MOSFETs

❖ GENERAL DESCRIPTION

The AMS4004 is the high cell density trenched N-ch MOSFETs, which provide excellent R_{DS(on)} and gate charge for most of the synchronous buck converter applications.

The AMS4004 meet the RoHS and Green Product requirement, 100% EAS guaranteed with full function reliability approved.

❖ FEATURES

- Advanced high cell density Trench technology
- Super Low Gate Charge
- Excellent CdV/dt effect decline
- 100% EAS Guaranteed
- Green Device Available

Product Summary

BVDSS	R _{DS(on)}	I _D
40V	12mΩ	8.5A

SOP8 Pin configuration

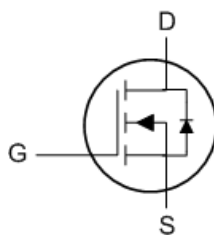
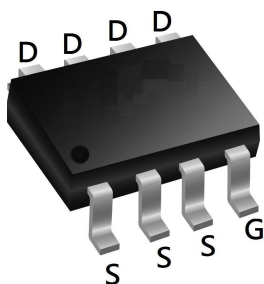

❖ **ORDER/MARKING INFORMATION**

Order Information	Top Marking
<p>AMS4004 X X</p> <p>Package Type: S: SOP-8L</p> <p>Packing: Blank : Bag, A : Taping</p>	<p>AM 4 0 0 4 → Part number</p> <p>Y Y W W X → ID code:internal</p> <p>WW:01~26 (A~Z), 27~52 (a~z)</p> <p>Year: 11=2011, 12=2012, ..., 19=2019</p>

❖ **ABSOLUTE MAXIMUM RATINGS**

Characteristics	Symbol	Rating	Units
Drain-Source Voltage	V_{DS}	40	V
Gate-Source Voltage	V_{GS}	±20	V
Continuous Drain Current, V_{GS} @ 10V (Note 1)	$I_D@T_A=25^\circ C$	8.5	A
Continuous Drain Current, V_{GS} @ 10V (Note 1)	$I_D@T_A=70^\circ C$	6.8	A
Pulsed Drain Current (Note 2)	I_{DM}	34	A
Single Pulse Avalanche Energy (Note 3)	EAS	69	mJ
Avalanche Current	I_{AS}	25	A
Total Power Dissipation (Note 4)	$P_D@T_A=25^\circ C$	1.5	W
Storage Temperature Range	T_{STG}	-55 to 150	°C
Operating Junction Temperature Range	T_J	-55 to 150	°C
Thermal Resistance Junction-ambient (Steady State) (Note 1)	$R_{\theta JA}$	85	°C/W
Thermal Resistance Junction-Case (Note 1)	$R_{\theta JC}$	36	°C/W

Note 1: The data tested by surface mounted on a 1 inch² FR-4 board with 2OZ copper.

Note 2: The data tested by pulsed , pulse width $\leq 300\mu s$, duty cycle $\leq 2\%$

Note 3: The EAS data shows Max. rating. The test condition is $V_{DD}=25V$, $V_{GS}=10V$, $L=0.1mH$, $I_{AS}=25A$

Note 4: The power dissipation is limited by 150°C junction temperature

Note 5: The Min. value is 100% EAS tested guarantee.

Note 6: The data is theoretically the same as I_D and I_{DM} , in real applications, should be limited by total power dissipation.

❖ ELECTRICAL CHARACTERISTICS

 (T_J=25 °C, unless otherwise noted)

Characteristics	Symbol	Conditions	Min.	Typ.	Max.	Unit
Drain-Source Breakdown Voltage	BV _{DSS}	V _{GS} =0V, I _D =250uA	40	-	-	V
BVDSS Temperature Coefficient	ΔBV _{DSS} /ΔT _J	Reference to 25°C, I _D =1mA	-	0.034	-	V/°C
Static Drain-Source On-Resistance (Note 2)	R _{DS(ON)}	V _{GS} =10V, I _D =8A	-	10	12	mΩ
		V _{GS} =4.5V, I _D =6A	-	14	17	
Gate Threshold Voltage	V _{GS(th)}	V _{GS} =V _{DS} , I _D =250uA	1.0	1.5	2.5	V
V _{GS(th)} Temperature Coefficient	ΔV _{GS(th)}		-	-5.64	-	mV/°C
Drain-Source Leakage Current	I _{DSS}	V _{DS} =32V, V _{GS} =0V, T _J =25°C	-	-	1	uA
		V _{DS} =32V, V _{GS} =0V, T _J =55°C	-	-	5	
Gate-Source Leakage Current	I _{GSS}	V _{GS} =±20V, V _{DS} =0V	-	-	±100	nA
Forward Transconductance	g _{fs}	V _{DS} =5V, I _D =8A	-	36	-	S
Gate Resistance	R _g	V _{DS} =0V, V _{GS} =0V, f=1MHz	-	2.1	4.2	Ω
Total Gate Charge (4.5V)	Q _g	V _{DS} =20V, V _{GS} =4.5V, I _D =8A	-	10.7	-	nC
Gate-Source Charge	Q _{gs}		-	3.3	-	
Gate-Drain Charge	Q _{gd}		-	4.2	-	
Turn-On Delay Time	T _{d(on)}	V _{DD} =12V, V _{GS} =10V, R _G =3.3Ω I _D =6A	-	8.6	-	ns
Rise Time	T _r		-	3.4	-	
Turn-Off Delay Time	T _{d(off)}		-	24.8	-	
Fall Time	T _f		-	2.2	-	
Input Capacitance	C _{iss}	V _{DS} =15V, V _{GS} =0V, f=1MHz	-	1314	-	pF
Output Capacitance	C _{oss}		-	120	-	
Reverse Transfer Capacitance	C _{rss}		-	88	-	
Guaranteed Avalanche Characteristics						
Single Pulse Avalanche Energy (Note 5)	EAS	V _{DD} =25V, L=0.1mH, I _{AS} =15A	45	-	-	mJ
Diode Characteristics						
Continuous Source Current (Note 1, 6)	I _S	V _G =V _D =0V, Force Current	-	-	8.5	A
Pulsed Source Current (Note 2, 6)	I _{SM}		-	-	34	A
Diode Forward Voltage (Note 2)	V _{SD}	V _{GS} =0V, I _S =1A, T _J =25°C	-	-	1.2	V

 Note 1: The data tested by surface mounted on a 1 inch² FR-4 board with 2OZ copper.

Note 2: The data tested by pulsed, pulse width ≤ 300us, duty cycle ≤ 2%

 Note 3: The EAS data shows Max. rating. The test condition is V_{DD}=25V, V_{GS}=10V, L=0.1mH, I_{AS}=25A

Note 4: The power dissipation is limited by 150°C junction temperature

Note 5: The Min. value is 100% EAS tested guarantee.

 Note 6: The data is theoretically the same as I_D and I_{DM}, in real applications, should be limited by total power dissipation.

❖ TYPICAL CHARACTERISTICS

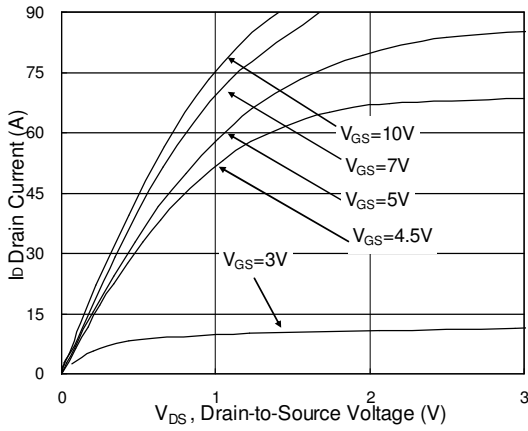

Fig.1 Typical Output Characteristics

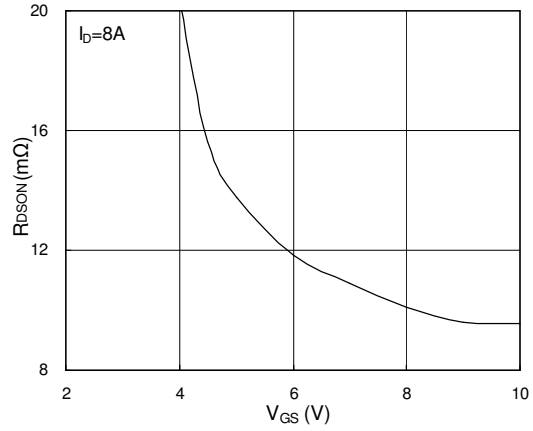

Fig.2 On-Resistance vs. G-S Voltage

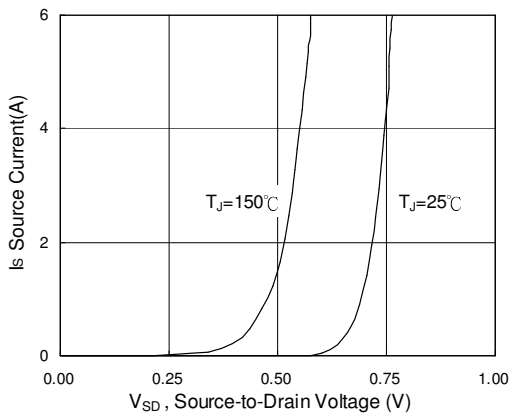

Fig.3 Forward Characteristics of Reverse

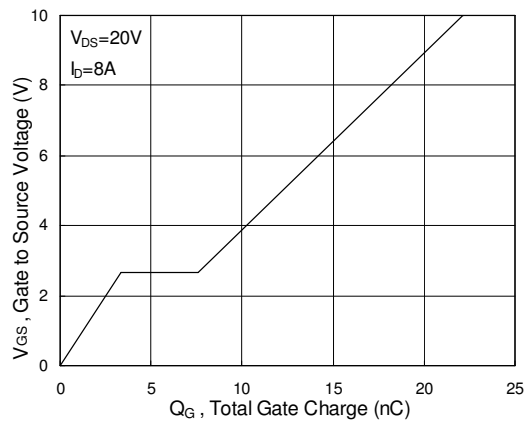

Fig.4 Gate-Charge Characteristics

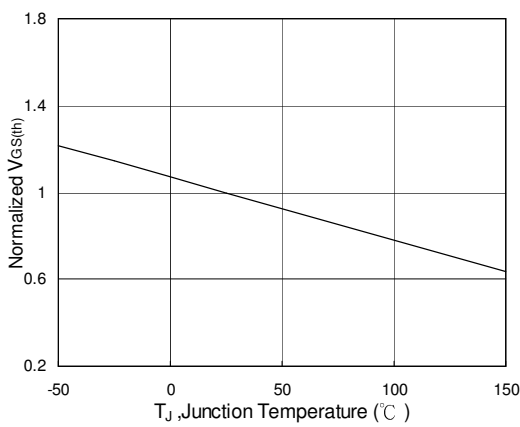

Fig.5 Normalized VGS(th) vs. Tj

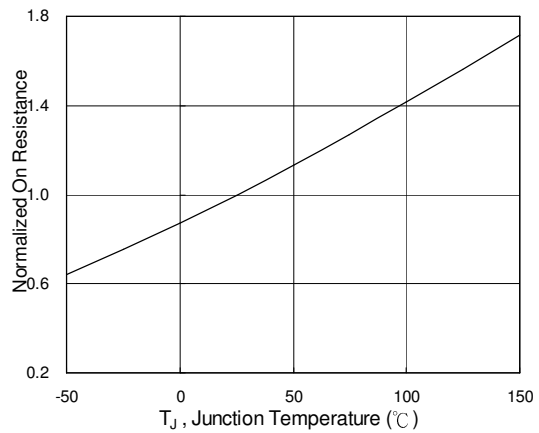

Fig.6 Normalized RDS(on) vs. Tj

❖ TYPICAL CHARACTERISTICS (COUNTINOUS)

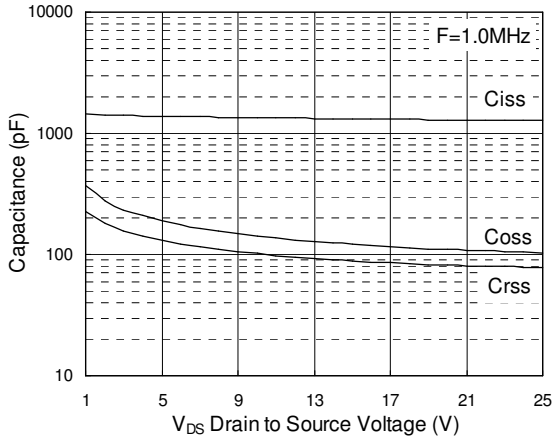

Fig.7 Capacitance

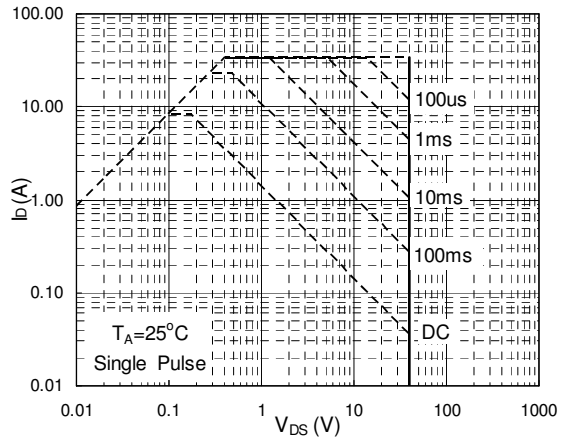

Fig.8 Safe Operating Area

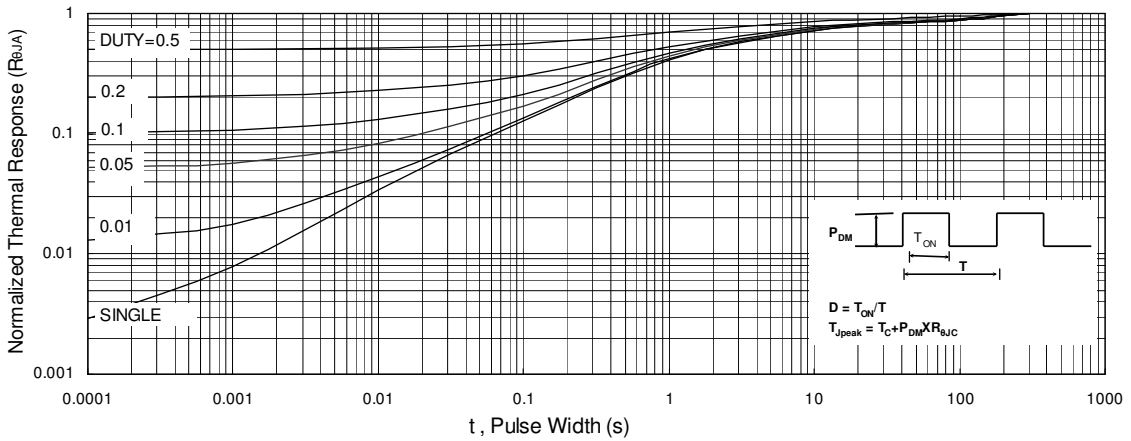

Fig.9 Normalized Maximum Transient Thermal Impedance

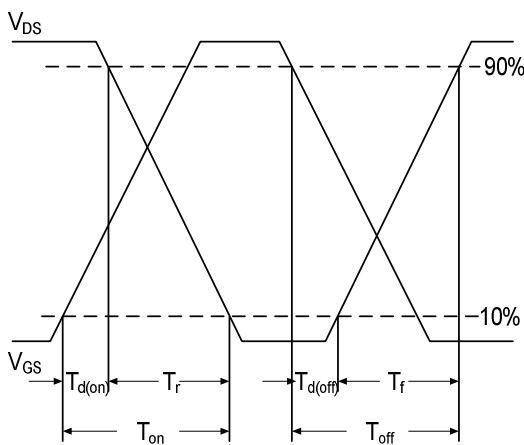

Fig.10 Switching Time Waveform

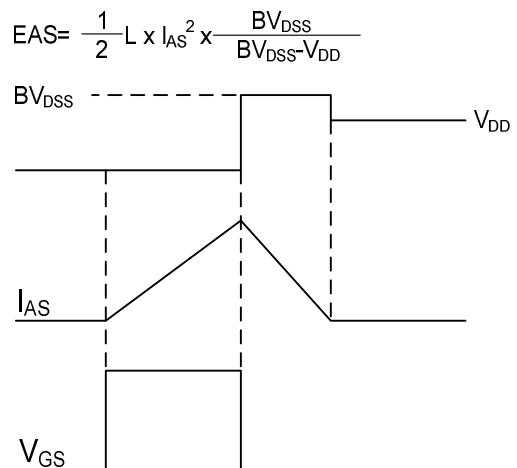
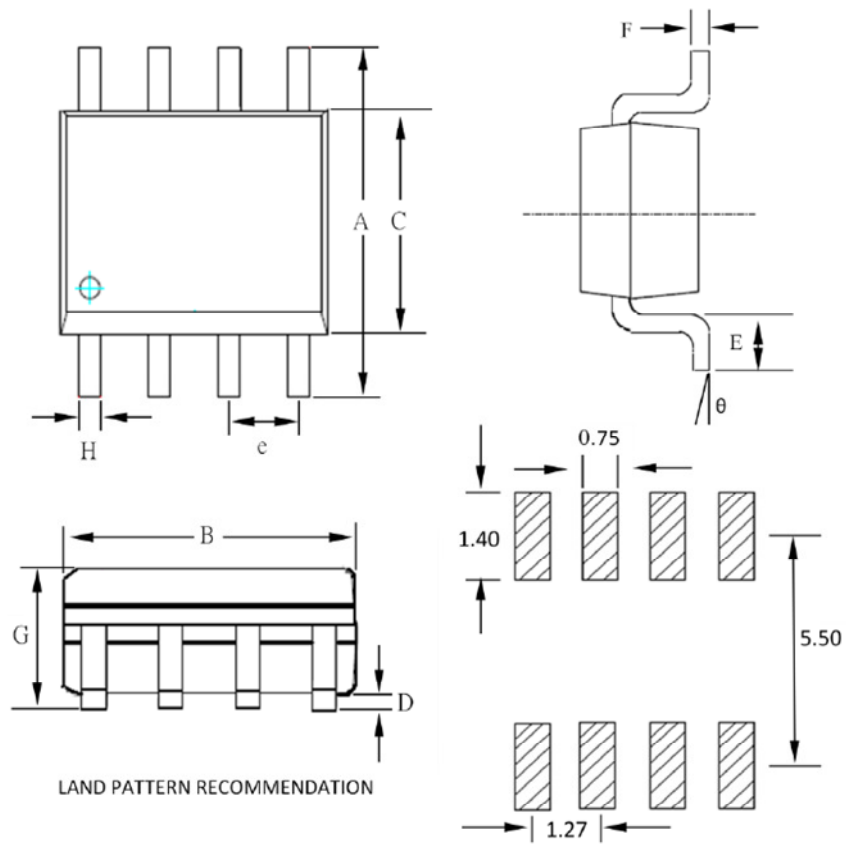

Fig.11 Unclamped Inductive Switching Waveform

❖ **PACKAGE OUTLINES**



Symbol	Dimensions in Millimeters			Dimensions in Inches		
	Min.	Nom.	Max.	Min.	Nom.	Max.
A	5.75	6.00	6.25	0.226	0.236	0.246
B	4.70	4.90	5.15	0.185	0.193	0.203
C	3.70	3.90	4.10	0.146	0.154	0.161
D	0.05	-	0.25	0.002	-	0.010
E	0.40	-	1.27	0.016	-	0.050
F	0.16	-	0.25	0.006	-	0.010
G	1.23	-	1.75	0.048	-	0.069
e	1.07	1.27	1.47	0.042	0.050	0.058
H	0.31	-	0.51	0.012	-	0.020
θ	0°	-	8°	0°	-	8°

Note:

1. PACKAGE BODY SIZES EXCLUDE MOLD FLASH AND GATE BURRS.
2. CONTROLLING DIMENSION IS MILLIMETER CONVERTED INCH DIMENSIONS ARE NOT NECESSARILY EXACTLY.