

2A LDO Linear Regulator with Enable

❖ GENERAL DESCRIPTION

The AX1209 is a low-dropout voltage regulator suitable for various electronic equipments. It provides constant voltage power source. The dropout voltage of AX1209 is 1.1V in full rated current (2A). This regulator has various functions such as a peak current protection, a thermal shut down, a short circuit protect.

The AX1209 is available in TO252-5L power package which features small size to reduce the junction-to-case resistance.

❖ FEATURES

- Operating voltage range: 7V~24V.
- Adjustable Output Version
- Low Dropout voltage: 1.1V (typical) at 2A Output Current.
- Current-Limit and Thermal Shutdown Protection.
- Short circuit protection.
- Shutdown function.
- Built internal driver.
- TO252-5L Pb-Free Package.

❖ BLOCK DIAGRAM

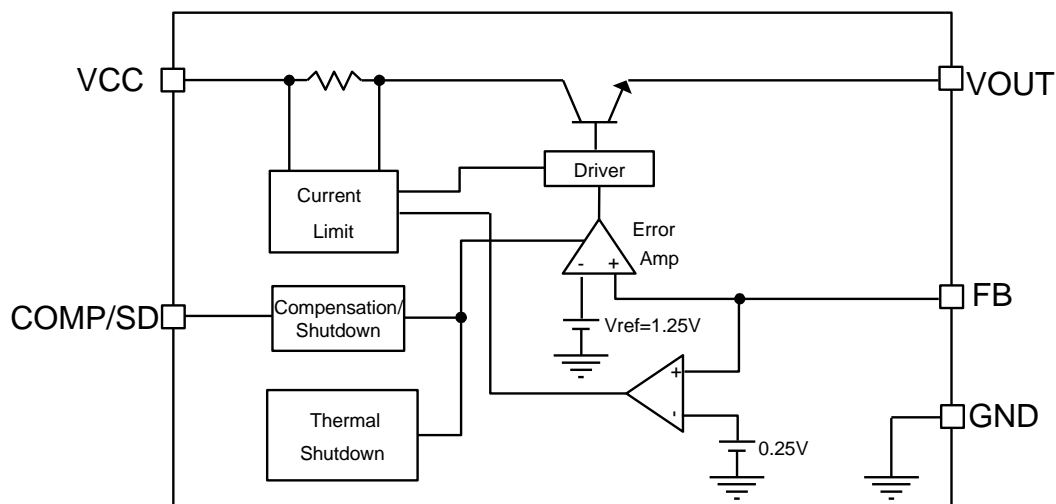

❖ PIN ASSIGNMENT

The package of AX1209 is TO252-5L; the pin assignment is given by:

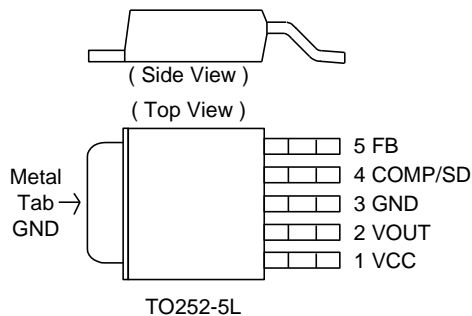

Name	Description
VCC	Operating voltage input
GND	Ground pin
FB	Feedback pin
COMP/SD	Compensation pin with shutdown function. In operating mode, these pin connect a capacitor to ground to preserve system stability. It is in shutdown mode, when the pin connect a P-MOSFET to drive it ON, this pin can be pull to low to turn driver OFF.
VOUT	Output Voltage pin

❖ ORDER/MARKING INFORMATION

Order Information	Top Marking
<p>AX1209 XX X</p> <p>Package D5 : TO252-5L</p> <p>Packing Blank : Tube A : Taping</p>	<p>Logo ← AX 1 2 0 9 → Part number YY WW X → ID code:internal WW:01~52 Year: 10=2010 11=2011</p>

❖ ABSOLUTE MAXIMUM RATINGS (T_A = 25°C)

Characteristics	Symbol	Rating	Unit
V _{CC} Supply Voltage	V _{CC}	-0.3 to 28	V
COMP/SD Pin Voltage	V _{COMP}	-0.3 to 6	V
FB Pin Voltage	V _{FB}	-0.3 to V _{CC}	V
Output Voltage	V _{OUT}	28	V
Output current	I _{OUT}	2.0	A
Power Dissipation	PD	Internal limited	W
Storage Temperature Range	T _{ST}	-65 to +150	°C
Junction Temperature Range	T _J	-40 to 125	°C
Operating Temperature Range	T _{OP}	-40 to +85	°C
Thermal Resistance from Junction to case	θ _{JC}	10	°C/W
Thermal Resistance from Junction to ambient	θ _{JA}	45	°C/W

Note: θ_{JA} is measured with the PCB copper area (need connect to Tap pin) of approximately 1.5 in² (Multi-layer).

❖ ELECTRICAL CHARACTERISTICS

(Unless otherwise specified, $T_A = 25^\circ\text{C}$, $V_{CC}=12\text{V}$)

Characteristics	Symbol	Conditions	Min	Typ	Max	Units
V_{CC} Supply Voltage	V_{CC}	$I_{OUT}=2\text{A}$	7	-	24	V
Adjust output voltage range	$V_{OUT-ADJ}$		5	-	24	V
FB Voltage	V_{FB}	AX1209A only	1.225	1.25	1.275	V
Quiescent Current	I_{CCQ}	No Load	-	4	7	mA
Shutdown Current	I_{SD}	$V_{COMP} = 0\text{V}$	-	1	1.5	mA
Load regulation (Note1)	V_{Load}	$5\text{mA} < I_{OUT} < 2\text{A}$	-	0.5	1.0	%/A
Line regulation	V_{Line}	$I_{OUT}=10\text{mA}$, $V_{OUT}+1.5\text{V}<V_{CC}<24$	-	0.1	0.5	%
Dropout Voltage	V_{DROP}	$I_{OUT} = 2\text{A}$, $\Delta V_{OUT}=1\%V_{OUT}$	-	1.1	1.3	V
Short circuit protect	I_{scp}	$V_{OUT} = 0\text{V}$	-	0.2	-	A
Current Limit (Note2)	CL		2.1	-	-	A
COMP current	I_{COMP}	COMP=0V	-	60	90	μA
Shutdown input threshold voltage	V_{COMP}	Regulator OFF	-	-	0.6	V
Ripple rejection ratio	PSRR	$F=120\text{Hz}$, $C_{OUT}=47\mu\text{F}$	-	55	-	dB
Thermal Shutdown	T_{SD}		-	150	-	$^\circ\text{C}$
Thermal Shutdown Hysteresis	T_{SH}		-	40	-	$^\circ\text{C}$

Note1: Regulation is measured at constant junction temperature by using pulsed testing with a low ON time.

Note2: Current limit is measured at constant junction temperature by using pulsed testing with a low ON time.

❖ APPLICATION CIRCUIT

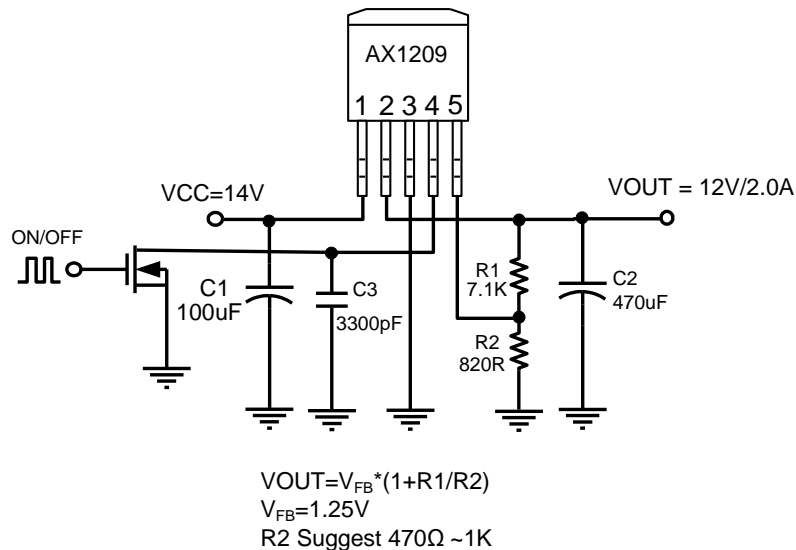

❖ APPLICATION INFORMATION

Setting the Output Voltage

Application circuit item shows the basic application circuit with adjustable output version. The external resistor sets the output voltage according to the following equation:

$$V_{OUT} = 1.25V \times \left(1 + \frac{R1}{R2}\right)$$

The R2 value form 470Ω to 1KΩ is recommended.

COMP/SD

This pin is including compensation and shutdown functions. In operating mode, these pin connect a capacitor (C3) to ground to preserve system stability, the C3 range is 2000pF to 3900pF. The 3300pF is recommended for all conditions. When it is in shutdown mode, the pin connect a P-MOSFET to drive it ON, this pin can be pull to low to turn driver OFF.

Input Capacitor Selection

The input capacitor reduces the surge current drawn from the input and Low ESR Capacitor has noise from the device. The input capacitor impedance at the switching frequency shall be less than input source impedance to prevent high frequency switching current passing to the input. A low ESR input capacitor sized for maximum RMS current must be used.

The capacitor voltage rating should be at least 1.5 times greater than the input voltage, and often much higher voltage ratings are needed to satisfy.

Output Capacitor Selection

The output capacitor is required to keep the output voltage ripple small and to ensure regulation loop stability. The output capacitor (C2) value selection is very important for this IC, please refer the below table to design.

$$7V \leq V_{CC} < 18V, C2 = 220\mu F \sim 470\mu F$$

$$16V < V_{CC} \leq 20V, C2 = 100\mu F$$

$$18V < V_{CC} \leq 24V, C2 = 47\mu F$$

The capacitor voltage rating should be at least 1.5 times greater than the output voltage, and often much higher voltage ratings are needed to satisfy.

❖ TYPICAL CHARACTERISTICS

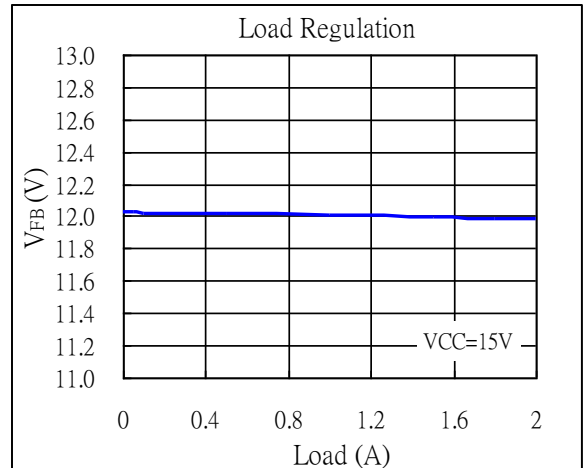
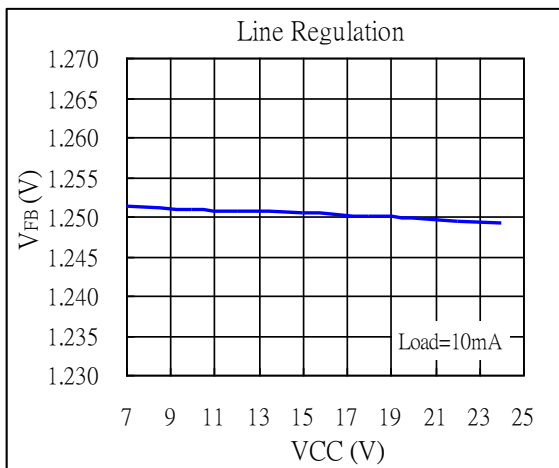
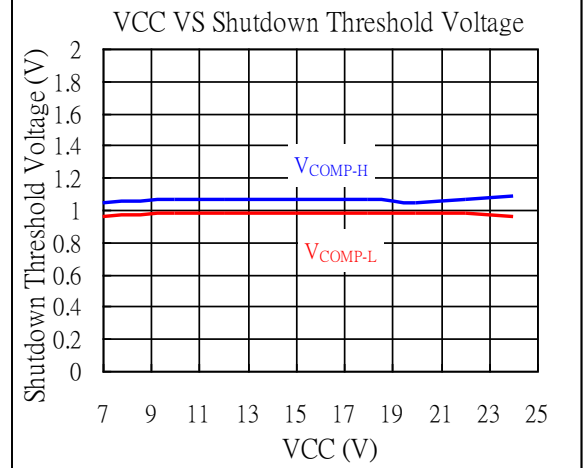
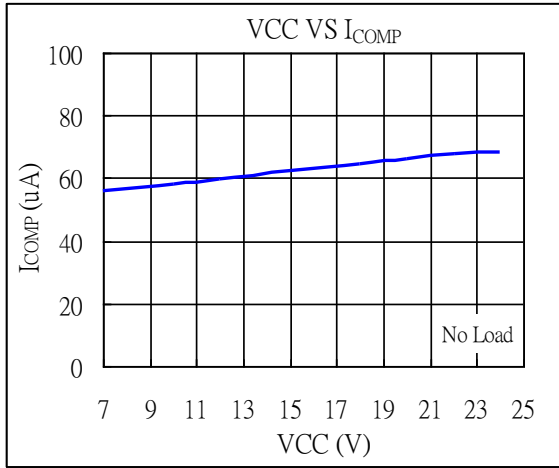
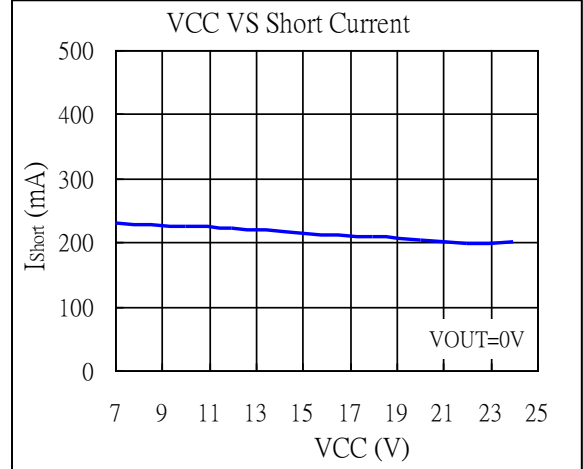
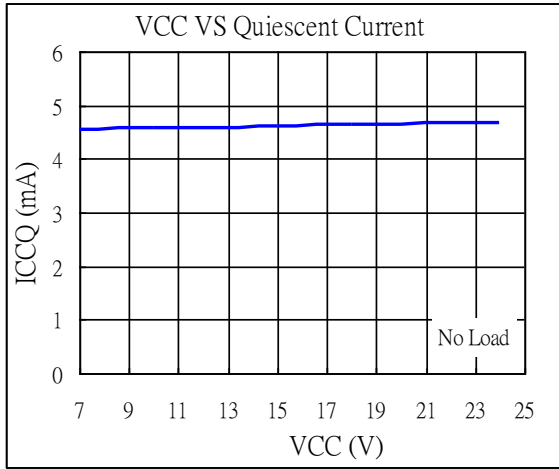

❖ TYPICAL CHARACTERISTICS (CONTINUED)

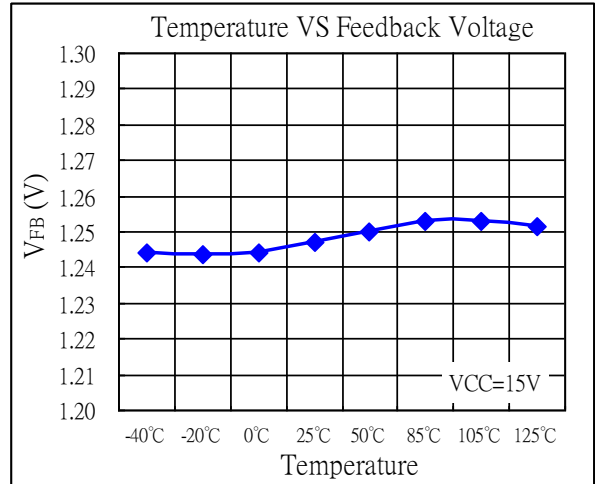
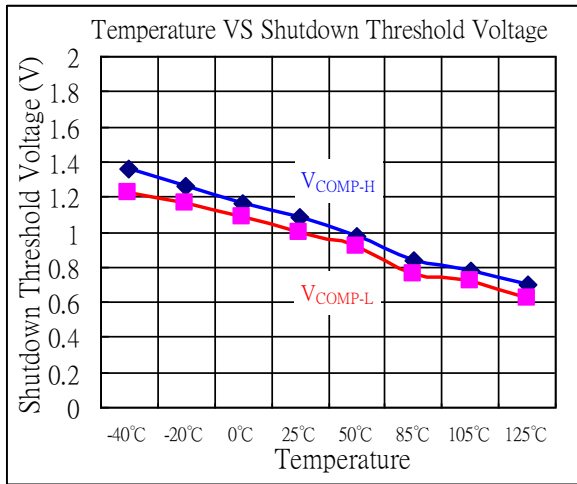
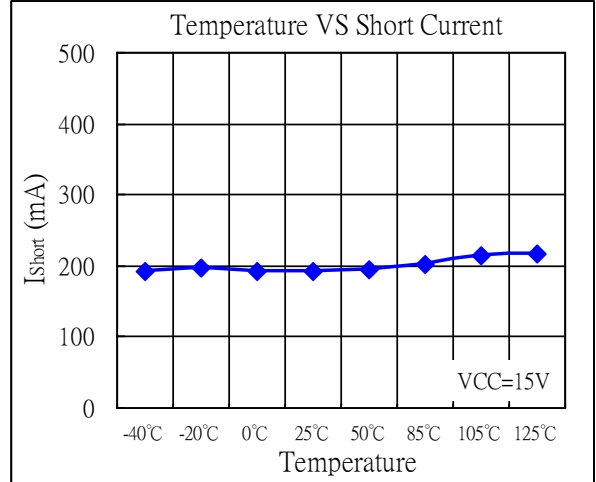
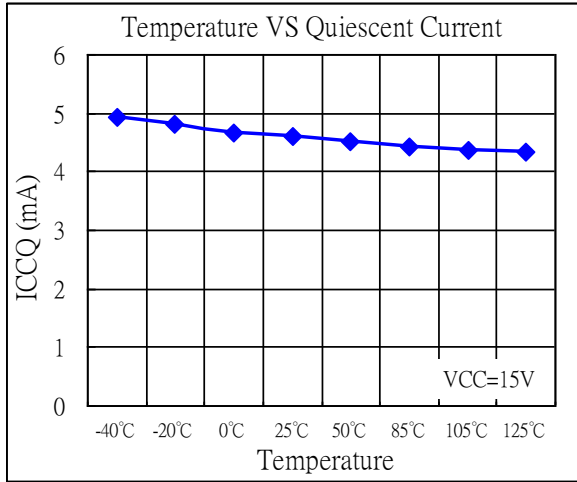

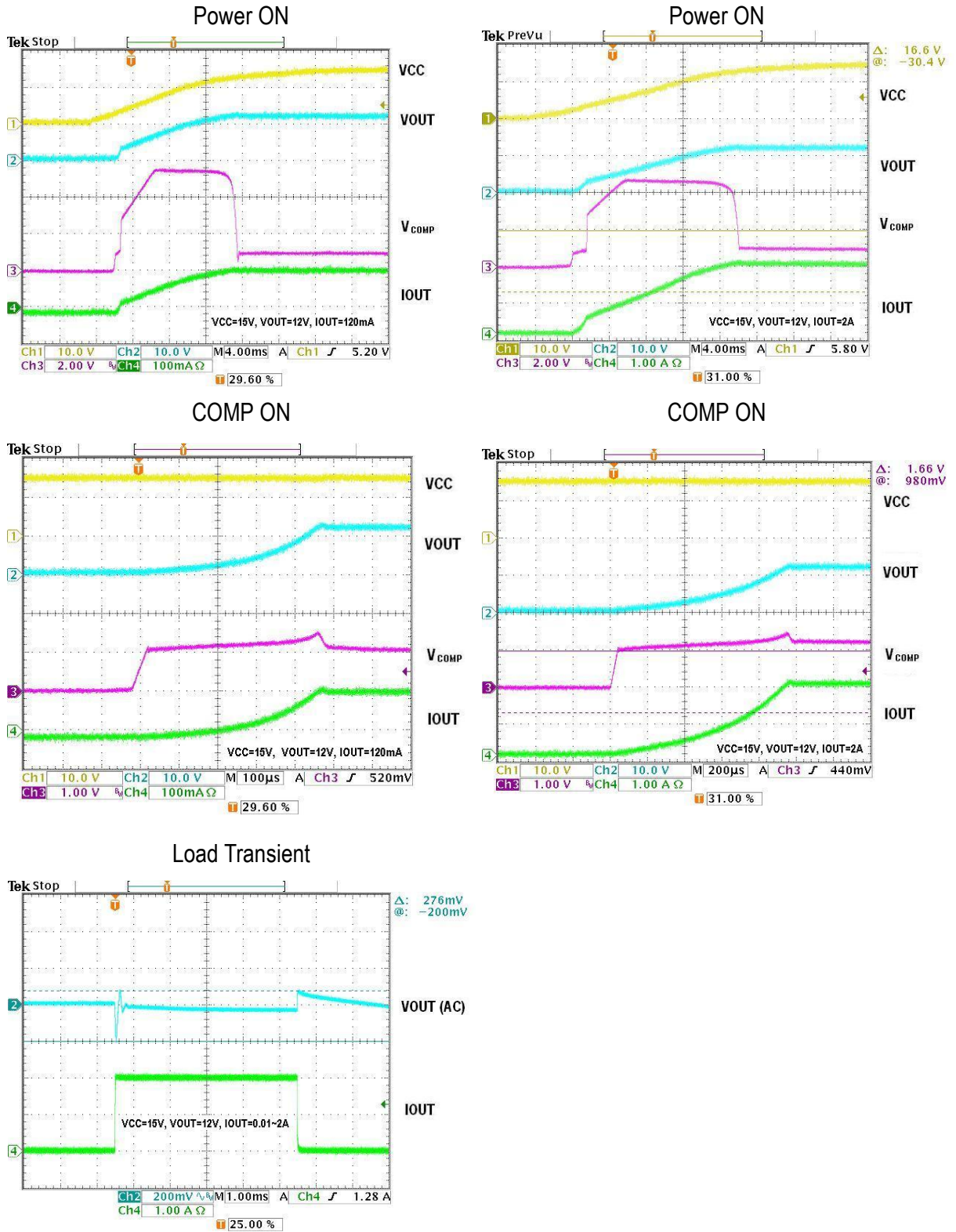
❖ TYPICAL CHARACTERISTICS (CONTINUED)

❖ PACKAGE OUTLINES

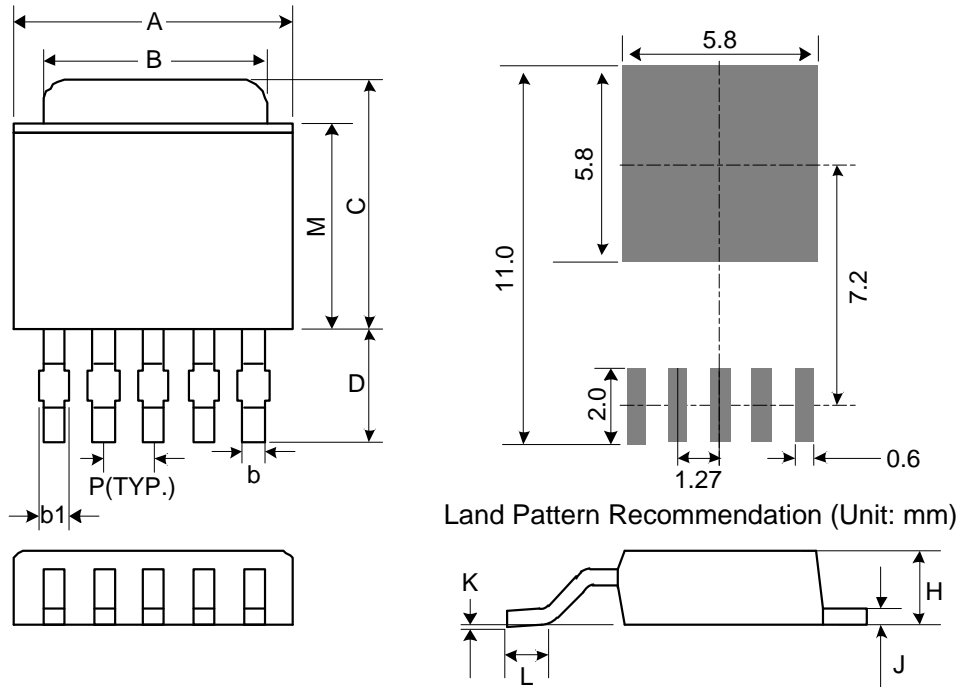

Symbol	Dimensions in Millimeters			Dimensions in Inches		
	Min.	Nom.	Max.	Min.	Nom.	Max.
A	6.35	6.6	6.73	0.25	0.26	0.265
B	5.21	5.33	5.46	0.205	0.21	0.215
C	6.86	7.24	7.62	0.27	0.285	0.3
D	2.67 REF			0.105 REF		
P	1.27 REF			0.050 REF		
H	2.18	2.29	2.39	0.086	0.09	0.094
J	0.46	0.51	0.58	0.018	0.02	0.023
K	0	0.08	0.13	0	0.003	0.005
L	1.4	1.6	1.78	0.055	0.063	0.07
M	5.33	5.46	5.59	0.21	0.215	0.22
b	0.38	0.56	0.71	0.015	0.022	0.028
b1	0.38	0.53	0.66	0.015	0.021	0.026

Mold flash shall not exceed 0.005inch per side