

## **50K/150KHz, 2A PWM Buck DC/DC Converter**

### ❖ GENERAL DESCRIPTION

The AX3010/A series are monolithic IC designed for a step-down DC/DC converter, and own the ability of driving a 2A load without additional transistor. It saves board space. The external shutdown function can be controlled by logic level and then come into standby mode. The internal compensation makes feedback control having good line and load regulation without external design. Regarding protected function, thermal shutdown is to prevent over temperature operating from damage; current limit is against over current operating of the output switch that set by outside resistance. If current limit function occurs and  $V_{FB}$  is down below 0.3V, the switching frequency will be reduced to 10 KHz for AX3010 and 20K for AX3010A; and over voltage protection (OVP) that can avoid high  $V_{OUT}$  voltage to damage circuit and capacitor. The EN/SS pin supply soft-start function that prevents overshoot and inrush current at startup, the soft-start time is be set up by outside capacitance. The chip is available in SOP-8L-EP package which features small size as SOP-8 with an Exposed Pad to reduce the junction-to-case resistance.

### ❖ FEATURES

- Maximum adjustable output voltage up to 38V.
- Typical switching frequency:  
AX3010 is 50K Hz.  
AX3010A is 150K Hz.
- Voltage mode non-synchronous PWM converter.
- Thermal-shutdown and current-limit protection.
- ON/OFF shutdown and soft-start control input.
- Short Circuit Protect (SCP).
- External current limit setting.
- Over Voltage Protect (OVP).
- Operating voltage can be up to 40V.
- Output load current: 2A.
- SOP-EP Pb-Free package.
- Built-in switching transistor on chip.

❖ BLOCK DIAGRAM

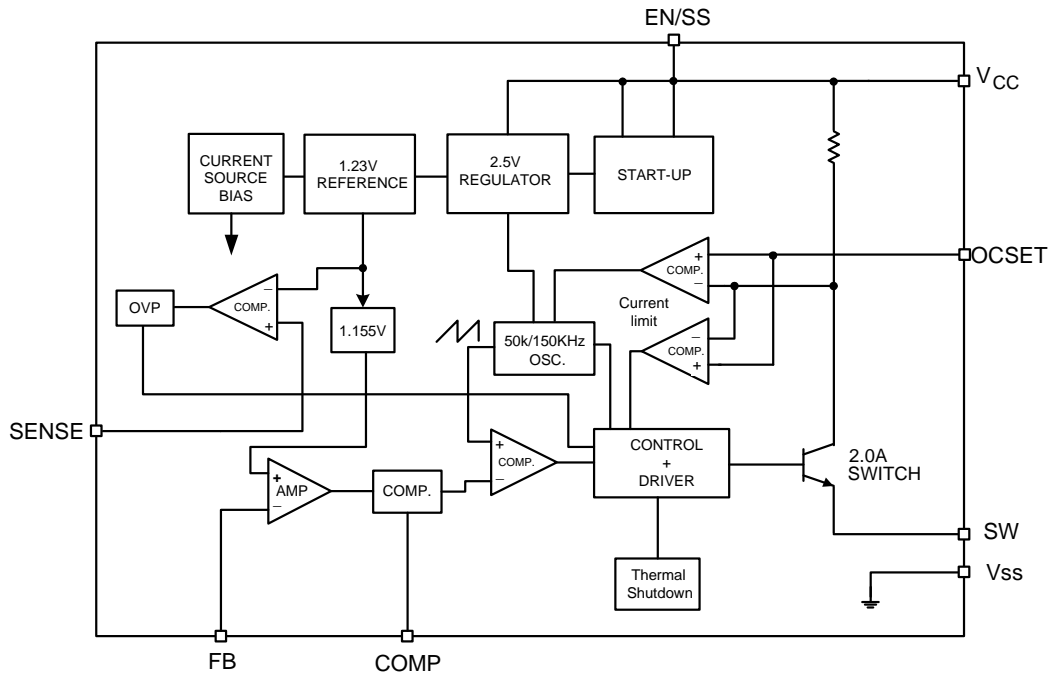

❖ PIN ASSIGNMENT

The package of AX3010/A is SOP-8L-EP; the pin assignment is given by:

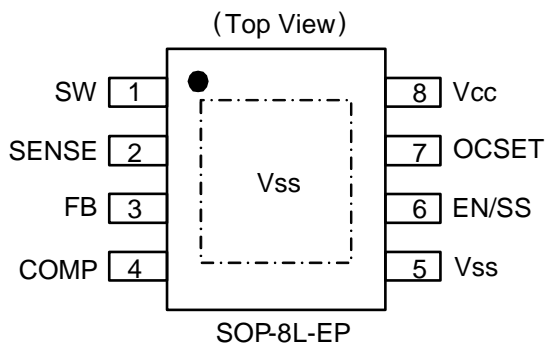

Name	Description
V <sub>CC</sub>	Operating voltage input
OCSET	Add an external resistor to set max switch output current
V <sub>SS</sub>	GND pin
FB	Output voltage feedback control
SW	Switch pin. Connect external inductor and diode here
SENSE	Over Voltage Sense Input
COMP	Compensation pin
EN/SS	ON/OFF Shutdown and Soft-start pin

❖ ORDER/MARKING INFORMATION

Order Information	Top Marking
<p>AX3010 X X X</p> <p>Frequency      Package Type      Packing</p> <p>Blank : 50KHz    ES: EP-SOP-8L    Blank : Tube</p> <p>A : 150KHz      A : Taping</p>	<p>Logo ← <b>AX3010</b> → Part number</p> <p>A YY WW X → ID code:internal</p> <p>Blank: AX3010      WW: 01~52</p> <p>A : AX3010A      Year: 10=2010 11=2011</p>

❖ ABSOLUTE MAXIMUM RATINGS

Characteristics	Symbol	Rating	Unit
Maximum Supply Voltage	$V_{CC}$	+45	V
EN/SS Pin Input Voltage	$V_{EN/SS}$	-0.3 to 6	V
COMP Pin Input Voltage	$V_{COMP}$	-0.3 to 6	V
Feedback Pin Voltage	$V_{FB}$	-0.3 to 12	V
OCSET Pin Input Voltage	$V_{OCSET}$	-0.3 to $V_{CC}$	V
SW Pin Voltage	$V_{SW}$	-0.3 to $V_{CC}$	V
SENSE Pin Voltage	$V_{SENSE}$	-0.3 to 12	V
Power Dissipation Internally limited	PD	$(T_J - T_A) / \theta_{JA}$	W
Storage Temperature Range	$T_{ST}$	-65 to +150	°C
Operating Temperature Range	$T_{OP}$	-40 to +125	°C
Thermal Resistance from Junction to case	$\theta_{JC}$	15	°C/W
Thermal Resistance from Junction to ambient	$\theta_{JA}$	40	°C/W

Note:  $\theta_{JA}$  is measured with the PCB copper area (need connect to Exposed Pad) of approximately 3 in<sup>2</sup> (Multi-layer).

❖ ELECTRICAL CHARACTERISTICS

(Unless otherwise specified,  $T_A = 25^\circ\text{C}$ ,  $V_{CC} = 12\text{V}$ ,  $V_{OUT} = 5\text{V}$ ,  $I_{LOAD} = 0.2\text{A}$ )

Characteristics	Symbol	Conditions	Min	Typ	Max	Units	
Operating Supply Voltage	$V_{CC}$		4.5	-	40	V	
Feedback Voltage	$V_{FB}$		1.143	1.155	1.167	V	
Feedback bias current	$I_{FB}$	$V_{FB} = 1.5\text{V}$	-	-10	-	nA	
Line Regulation		$V_{CC} = 10 \sim 40\text{V}$	-	0.1	0.2	%	
Load Regulation		$I_{OUT} = 0 \sim 2\text{A}$	-	0.1	0.2	%	
Quiescent Current	$I_{CCQ}$	$V_{FB} = 2\text{V}$ force driver off	-	3	6	mA	
Shutdown supply Current	$I_{SD}$	$V_{EN/SS} = 0\text{V}$ $V_{CC} = 40\text{V}$	-	160	-	uA	
Oscillator frequency	$F_{OSC}$	AX3010	45	50	55	KHz	
		AX3010A	120	150	170		
Oscillator frequency of short circuit protect	$F_{SCP}$	$V_{FB} < 0.3\text{V}$	AX3010	-	10	-	KHz
			AX3010A	-	20	-	
Max. Duty Cycle (ON)	DC	$V_{FB} = 0\text{V}$ force driver on	-	100	-	%	
Min. Duty Cycle (OFF)		$V_{FB} = 12\text{V}$ force driver off	-	0	-		
Saturation voltage	$V_{SAT}$	$I_{OUT} = 2\text{A}$ , No outside circuit $V_{FB} = 0\text{V}$ force driver on	-	1.0	1.2	V	

Sense Voltage	V <sub>SENSE</sub>		1.205	1.23	1.255	V
SW pin leakage current SW pin=0V	I <sub>SWL</sub>	No outside circuit V <sub>FB</sub> =2V force driver off	-	-	-200	uA
SW pin leakage current SW pin=-0.8V		V <sub>CC</sub> =40V force driver off	-	-5	-	mA
EN pin logic input threshold voltage	V <sub>IL</sub>	Low (regulator OFF)	-	1.3	0.6	V
	V <sub>IH</sub>	High (regulator ON)	2.0		-	
EN/SS pin charge current	I <sub>EN/SS</sub>	V <sub>EN/SS</sub> =0V, V <sub>CC</sub> =40V	-	7	-	uA
Thermal shutdown Temp	T <sub>SD</sub>		-	155	-	°C
Thermal Shutdown Hysteresis	T <sub>SH</sub>		-	35	-	°C

### ❖ APPLICATION CIRCUIT

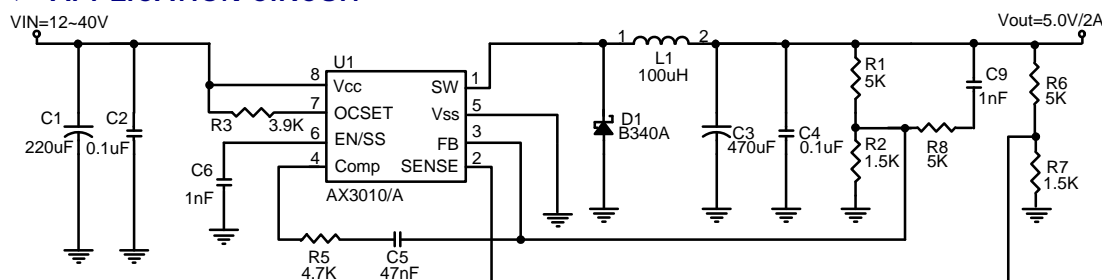

$$V_{OUT} = V_{FB} \times \left(1 + \frac{R1}{R2}\right), V_{FB} = 1.155V, R2 = 0.7K \sim 1.8K$$

### ❖ FUNCTION DESCRIPTIONS

V<sub>CC</sub>

This is the positive input supply for the IC switching regulator. A suitable input bypass capacitor must be presented at this pin to minimize voltage transients and to supply the switching currents needed by the regulator.

V<sub>SS</sub>

Circuit ground.

SW

Internal switch. The voltage at this pin switches between (+V<sub>CC</sub> - V<sub>SAT</sub>) and approximately -0.5V, with a duty cycle of approximately V<sub>OUT</sub> / V<sub>CC</sub>. To minimize coupling to sensitive circuitry, the PC board copper area connected to this pin should be minimized.

## FB

Sense the regulated output voltage to complete the feedback loop.

## EN/SS

Allow the switching regulator circuit to be shutdown using logic level signals thus dropping the total input supply current to approximately 160uA. Pulling this pin below a threshold voltage of approximately 0.6V shuts the regulator off, and pulling this pin above 2.0V turns the regulator on. However this pin keeps a soft start function simultaneously. Add a capacitor from EN to GND, the 7uA current can be charge the capacitor. The charge time is soft start time. If shutdown and soft start features are not needed, the EN pin can be floating.

## OCSET

The current limit threshold is setting by the external resistor (R3) connecting from  $V_{CC}$  supply to OCSET pin. Normally, the current limit setting more than  $I_{OUT}$  0.8A, Please refer the table for setting the minimum current limit value:

R3 ( $\Omega$ )	Current Limit (A)
1.5K	1.22
1.8K	1.44
2.2K	1.78
2.7K	2.14
3K	2.34
3.3K	2.56
3.9K	2.98

## SENSE

The Over Voltage sense pin, If  $V_{SENSE} > 1.23V$ , the OVP is happened that it can turn-off the driver. You can set VOUT OVP voltage by outside resistances (R6 and R7).

## COMP

The compensation pin. The COMP pin connects R5 and C5 to FB pin, The C5 use 47nF and R5 use 4.7K $\Omega$  for all condition.

❖ APPLICATION INFORMATION

Setting the Output Voltage

Application circuit item shows the basic application circuit with adjustable output version. The external resistor sets the output voltage according to the following equation:

$$V_{OUT} = 1.155V \times \left(1 + \frac{R1}{R2}\right)$$

Table 1 Resistor select for output voltage setting

V <sub>OUT</sub>	R2	R1
5.0V	1.5K	5K
3.27V	1.2K	2.2K

Inductor Selection

For most designs, the operates with inductors of 82μH to 100μH for AX3010. The inductor value can be derived from the following equation:

$$L = \frac{V_{OUT} \times (V_{IN} - V_{OUT})}{V_{IN} \times \Delta I_L \times f_{OSC}}$$

Where is inductor Ripple Current. Large value inductors lower ripple current and small value inductors result in high ripple currents. Choose inductor ripple current approximately 20% of the maximum load current 2A, ΔI<sub>L</sub>=0.4A. The DC current rating of the inductor should be at least equal to the maximum load current plus half the ripple current to prevent core saturation (2A+0.2A).

Please refer the recommend table for setting the inductor value:

L1 recommend value (V <sub>IN</sub> =12V ,I <sub>OUT</sub> =2A,)			
Part No.	V <sub>OUT</sub>	3.3V	5V
AX3010	L1 Value	82uH	100uH
AX3010A		33uH	47uH

Input Capacitor Selection

This capacitor should be located close to the IC using short leads and the voltage rating should be approximately 1.5 times the maximum input voltage. The RMS current rating requirement for the input capacitor of a buck regulator is approximately 1/2 the DC load current. A low ESR input capacitor sized for maximum RMS current must be used. A 220μF low ESR capacitor for most applications is sufficient.

## Output Capacitor Selection

The output capacitor is required to filter the output and provide regulator loop stability. The important capacitor parameters are; the 100KHz Equivalent Series Resistance (ESR), the RMS ripples current rating, voltage rating, and capacitance value. For the output capacitor, the ESR value is the most important parameter. The ESR can be calculated from the following formula.

$$V_{RIPPLE} = \Delta I_L \times ESR = 0.4A \times 130m\Omega = 52mV$$

An aluminum electrolytic capacitor's ESR value is related to the capacitance and its voltage rating. In most case, higher voltage electrolytic capacitors have lower ESR values. Most of the time, capacitors with much higher voltage ratings may be needed to provide the low ESR values required for low output ripple voltage. It is recommended to replace this low ESR capacitor by using a 470 $\mu$ F low ESR values < 130m $\Omega$ .

## Thermal Considerations

The SOP-8L-EP package needs a heat sink under most conditions. The heat sink connect exposed pad of AX3010/A to obtain best effect. The size of the heat sink depends on the input voltage, the output voltage, the load current and the ambient temperature. The AX3010/A junction temperature rise above ambient temperature for a 2A load and different input and output voltages.

❖ TYPICAL CHARACTERISTICS

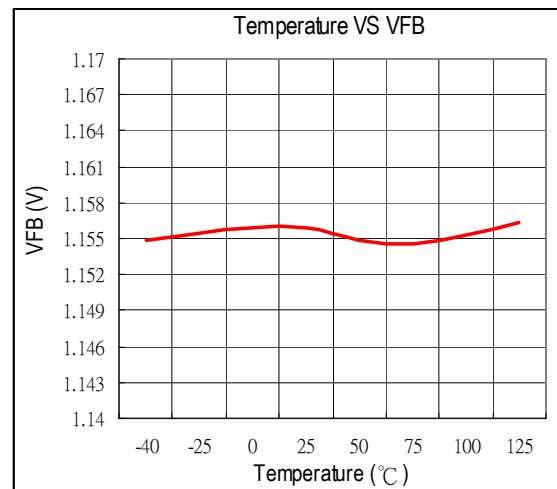
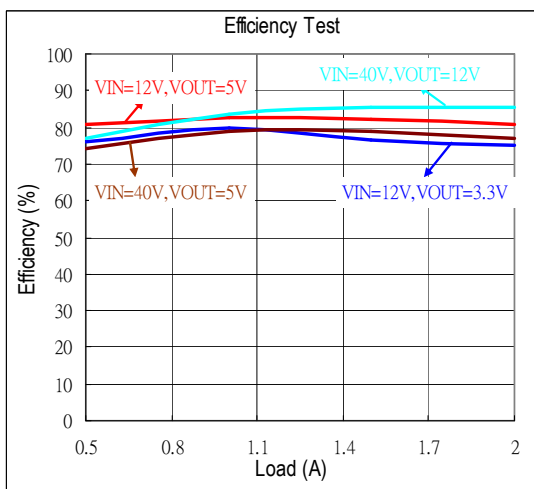
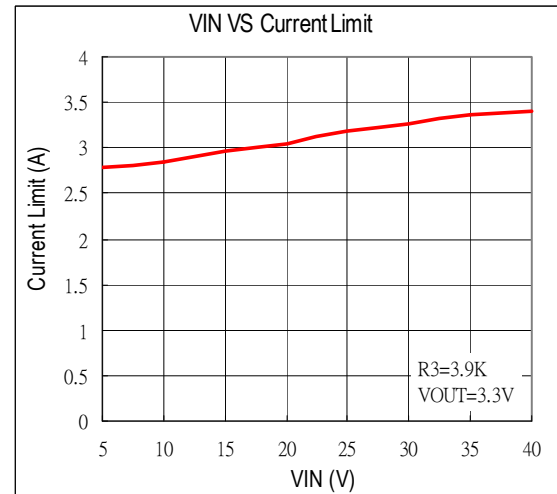
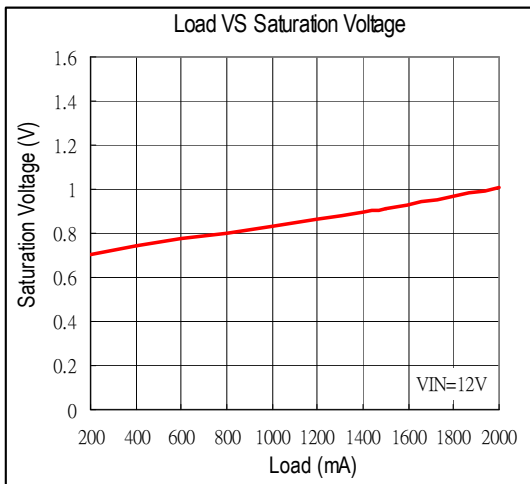
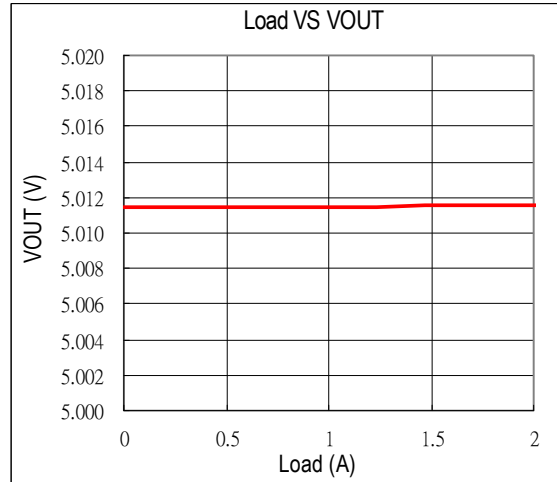
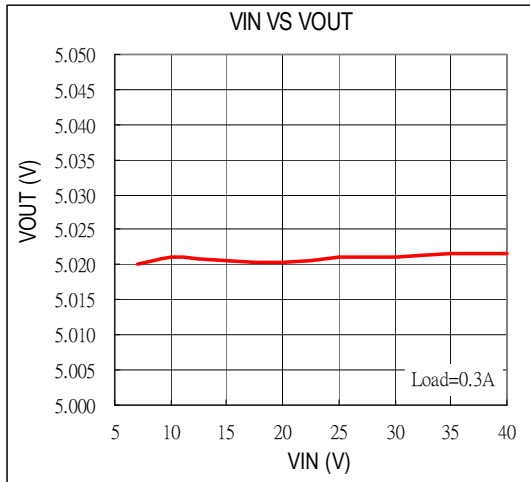



❖ TYPICAL CHARACTERISTICS (CONTINUES)

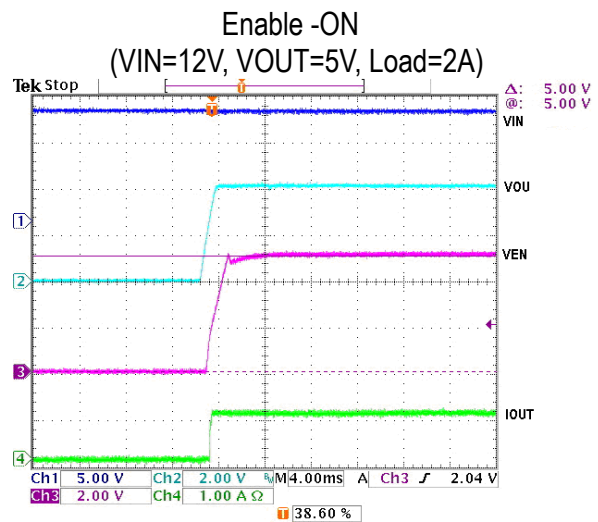
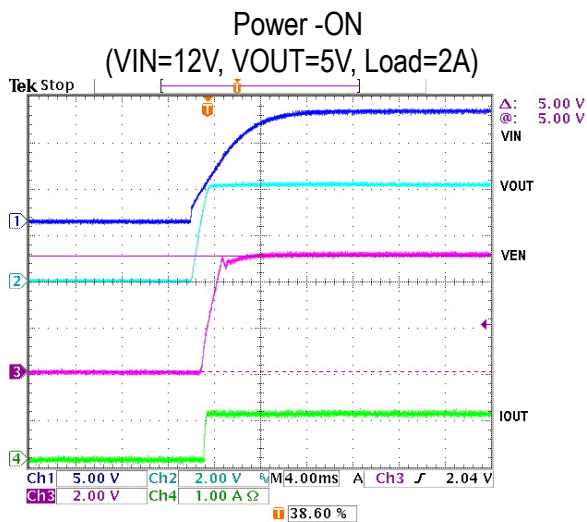
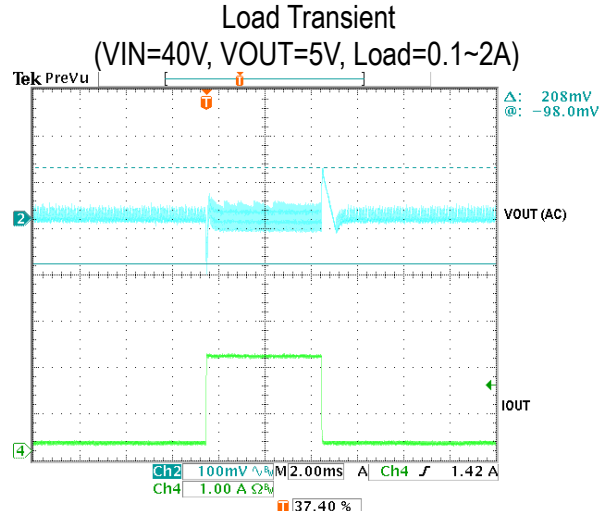
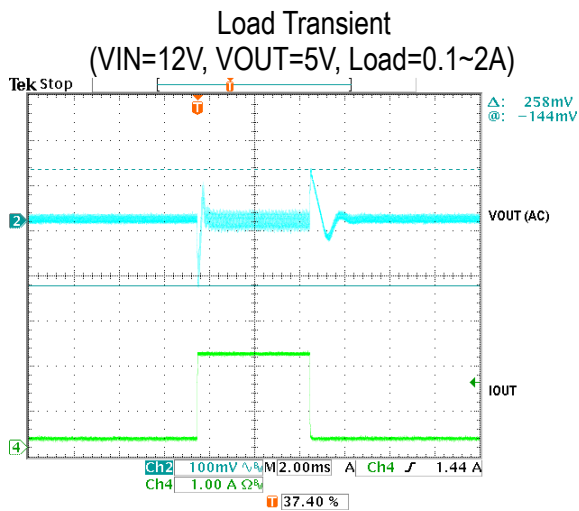
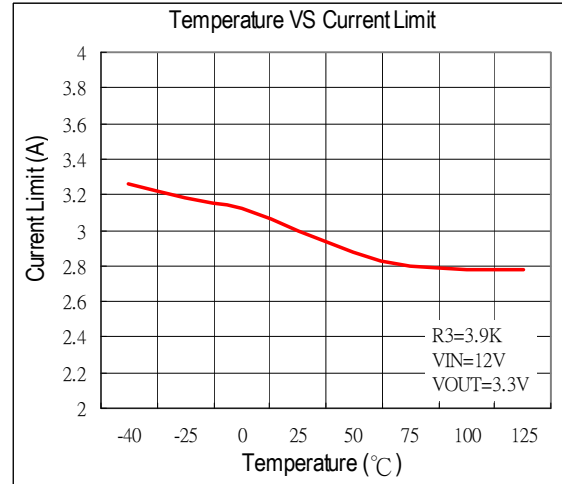
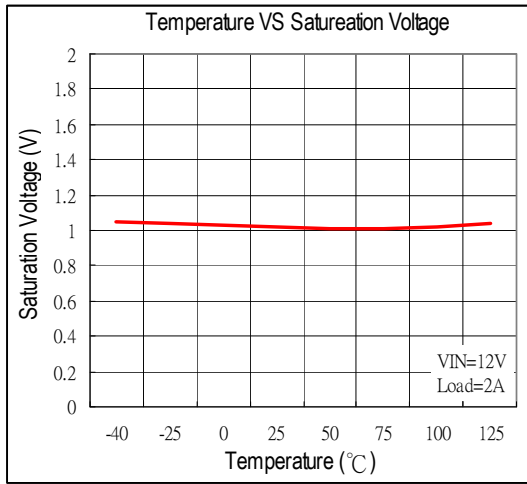

❖ PACKAGE OUTLINES

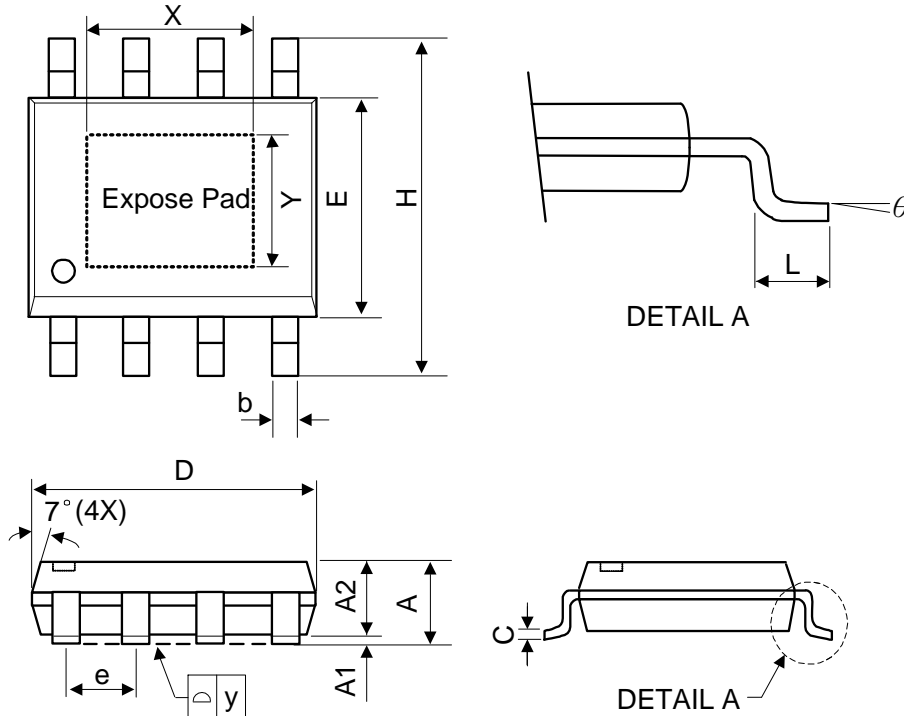

Symbol	Dimensions in Millimeters			Dimensions in Inches		
	Min.	Nom.	Max.	Min.	Nom.	Max.
A	-	-	1.75	-	-	0.069
A1	0	-	0.15	0	-	0.06
A2	1.25	-	-	0.049	-	-
C	0.1	0.2	0.25	0.0075	0.008	0.01
D	4.7	4.9	5.1	0.185	0.193	0.2
E	3.7	3.9	4.1	0.146	0.154	0.161
H	5.8	6	6.2	0.228	0.236	0.244
L	0.4	-	1.27	0.015	-	0.05
b	0.31	0.41	0.51	0.012	0.016	0.02
e	1.27 BSC			0.050 BSC		
y	-	-	0.1	-	-	0.004
X	-	2.34	-	-	0.092	-
Y	-	2.34	-	-	0.092	-
θ	0°	-	8°	0°	-	8°

Mold flash shall not exceed 0.25mm per side  
JEDEC outline: MS-012 BA