

## **50KHz, 2A PWM Buck DC/DC Converter**

### ❖ GENERAL DESCRIPTION

The AX3011 series are monolithic IC designed for a step-down DC/DC converter, and own the ability of driving a 2.5A load without additional transistor. It saves board space. The external shutdown function can be controlled by logic level and then come into standby mode. The internal compensation makes feedback control having good line and load regulation without external design. Regarding protected function, thermal shutdown is to prevent over temperature operating from damage; current limit is against over current operating of the output switch that set by outside resistance. If current limit function occurs and  $V_{FB}$  is down below 0.3V, the switching frequency will be reduced to 10 KHz; and over voltage protection (OVP) that can avoid high  $V_{OUT}$  voltage to damage circuit and capacitor. The chip is available in SOP-8L-EP package which features small size as SOP-8L with an Exposed Pad to reduce the junction-to-case resistance.

### ❖ FEATURES

- Operating voltage can be up to 40V.
- Maximum adjustable output voltage up to 38V.
- Typical switching frequency is 50K Hz.
- Voltage mode non-synchronous PWM converter.
- Thermal-shutdown and current-limit protection.
- Short Circuit Protect (SCP).
- External current limit setting.
- Over Voltage Protect (OVP) Sense and Output.
- Output load current: 2A.
- Low power standby mode.
- Built-in switching transistor on chip.
- SOP-8L-EP Pb-Free packages.

❖ **BLOCK DIAGRAM**

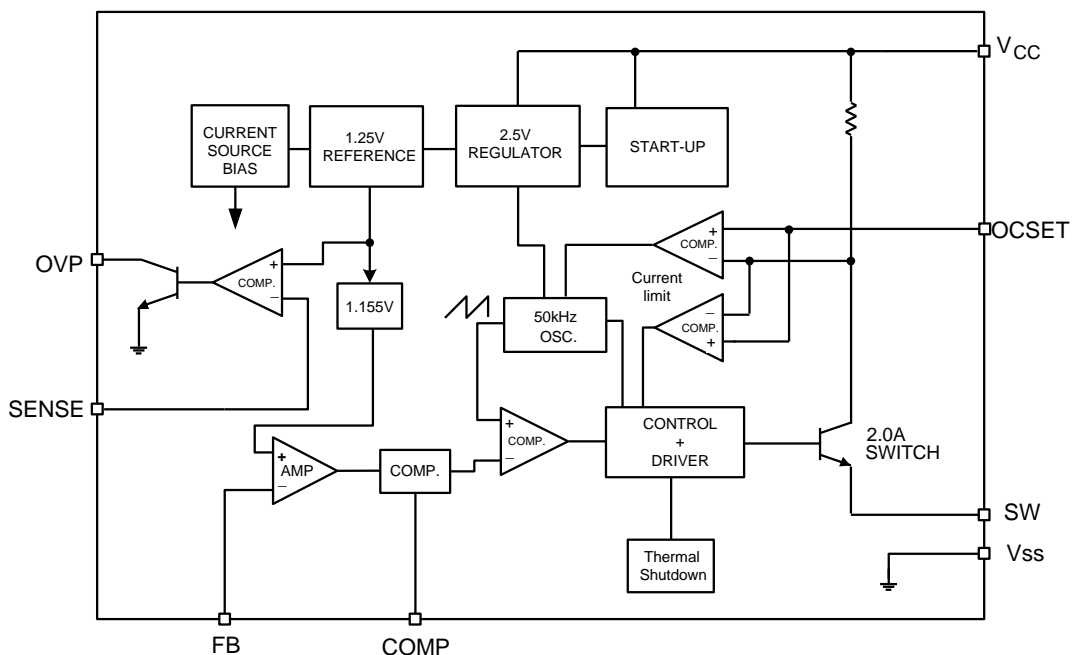

❖ **PIN ASSIGNMENT**

The package of AX3011 is SOP-8L-EP; the pin assignment is given by:

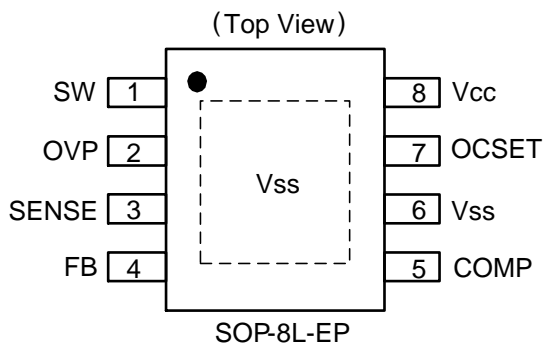

Name	Description
V <sub>CC</sub>	Operating voltage input
OCSET	Add an external resistor to set max switch output current
V <sub>SS</sub>	GND pin
FB	Output voltage feedback control
SW	Switch pin. Connect external inductor and diode here.
OVP	OVP Output pin.
COMP	Compensation pin
SENSE	Over Voltage Sense Input

❖ **ORDER/MARKING INFORMATION**

Order Information	Top Marking
<p>AX3011 <b>XX</b> <b>X</b></p> <p>Package Type      Packing</p> <p>ES: EP-SOP-8L      Blank : Tube</p> <p>  A : Taping</p>	<p>Logo ← <b>AX</b> 3 0 1 1 → Part number</p> <p>  Y Y W W X → ID code:internal</p> <p>  → WW: 01~52</p> <p>  → Year: 10=2010</p> <p>  11=2011</p>

### ❖ ABSOLUTE MAXIMUM RATINGS

Characteristics	Symbol	Rating	Unit
Maximum Supply Voltage	V <sub>CC</sub>	+45	V
COMP Pin Input Voltage	V <sub>COMP</sub>	-0.3 to 6	V
Feedback Pin Voltage	V <sub>FB</sub>	-0.3 to 12	V
SENSE Pin Voltage	V <sub>SENSE</sub>	-0.3 to 12	V
OCSET Pin Input Voltage	V <sub>OCSET</sub>	-0.3 to V <sub>CC</sub>	V
SW Pin Voltage	V <sub>SW</sub>	-0.3 to V <sub>CC</sub>	V
OVP Pin Voltage	V <sub>OVP</sub>	-0.3 to V <sub>CC</sub>	V
Power Dissipation Internally limited	PD	(T <sub>J</sub> -T <sub>A</sub> ) / θ <sub>JA</sub>	W
Storage Temperature Range	T <sub>ST</sub>	-65 to +150	°C
Operating Temperature Range	T <sub>OP</sub>	-40 to +125	°C
Thermal Resistance from Junction to case	θ <sub>JC</sub>	15	°C/W
Thermal Resistance from Junction to ambient	θ <sub>JA</sub>	40	°C/W

Note: θ<sub>JA</sub> is measured with the PCB copper area(need connect to Exposed Pad) of approximately 3 in<sup>2</sup> (Multi-layer).

### ❖ ELECTRICAL CHARACTERISTICS

(Unless otherwise specified, T<sub>A</sub>=25°C, V<sub>CC</sub>=12V, V<sub>OUT</sub>=5V, I<sub>LOAD</sub> = 0.2A)

Characteristics	Symbol	Conditions	Min	Typ	Max	Units
Operating Supply Voltage	V <sub>CC</sub>		4.5	-	40	V
Feedback Voltage	V <sub>FB</sub>		1.143	1.155	1.167	V
Feedback bias current	I <sub>FB</sub>	V <sub>FB</sub> =1.5V	-	-10	-	nA
Line Regulation		V <sub>CC</sub> =10~40V	-	0.1	0.2	%
Load Regulation		I <sub>OUT</sub> =0~2A	-	0.1	0.2	%
Quiescent Current	I <sub>CCQ</sub>	V <sub>FB</sub> =2V force driver off	-	3	6	mA
Oscillator frequency	F <sub>OSC</sub>		45	50	55	KHz
Oscillator frequency of short circuit protect	F <sub>SCP</sub>	V <sub>FB</sub> <0.3V	-	10	-	KHz
Max. Duty Cycle (ON)	DC	V <sub>FB</sub> =0V force driver on	-	100	-	%
Min. Duty Cycle (OFF)		V <sub>FB</sub> =12V force driver off	-	0	-	
Saturation voltage	V <sub>SAT</sub>	I <sub>OUT</sub> =2A, No outside circuit V <sub>FB</sub> =0V force driver on	-	1.0	1.2	V
Sense Voltage	V <sub>SENSE</sub>		1.205	1.23	1.255	V

❖ **ELECTRICAL CHARACTERISTICS (CONTINUES)**

(Unless otherwise specified, T<sub>A</sub>=25°C, V<sub>CC</sub>=12V, V<sub>OUT</sub>=5V, I<sub>LOAD</sub> = 0.2A)

OVP Voltage	V <sub>OVP</sub>	V <sub>SENSE</sub> =1.5V, I <sub>OVP</sub> =3mA	-	0.35	0.5	V
SW pin leakage current SW pin=0V	I <sub>SWL</sub>	No outside circuit V <sub>FB</sub> =2V force driver off	-	-	-200	uA
SW pin leakage current SW pin=-0.8V		V <sub>CC</sub> =40V force driver off	-	-5	-	mA
Thermal shutdown Temp	T <sub>SD</sub>		-	155	-	°C
Thermal Shutdown Hysteresis	T <sub>SH</sub>		-	35	-	°C

❖ **APPLICATION CIRCUIT**

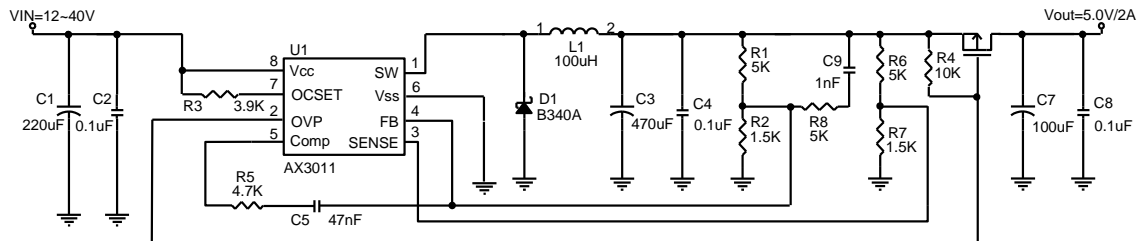

$$V_{OUT} = V_{FB} \times \left(1 + \frac{R1}{R2}\right), V_{FB} = 1.155V, R2 = 0.7K \sim 1.8K$$

❖ **FUNCTION DESCRIPTIONS**

**V<sub>CC</sub>**

This is the positive input supply for the IC switching regulator. A suitable input bypass capacitor must be presented at this pin to minimize voltage transients and to supply the switching currents needed by the regulator.

**V<sub>SS</sub>**

Circuit ground.

**SW**

Internal switch. The voltage at this pin switches between  $(+V_{CC} - V_{SAT})$  and approximately  $-0.5V$ , with a duty cycle of approximately  $V_{OUT} / V_{CC}$ . To minimize coupling to sensitive circuitry, the PC board copper area connected to this pin should be minimized.

**FB**

Sense the regulated output voltage to complete the feedback loop.

**OCSET**

The current limit threshold is setting by the external resistor (R3) connecting from  $V_{CC}$  supply to OCSET pin. Normally, the current limit setting more than  $I_{OUT} 0.8A$ , Please refer the table for setting the minimum current limit value:

R3 ( $\Omega$ )	Current Limit (A)
1.5K	1.22
1.8K	1.44
2.2K	1.78
2.7K	2.14
3K	2.34
3.3K	2.56
3.9K	2.98

**OVP**

The OVP pin must pull high a 10K resistance, If  $V_{SENSE} > 1.23V$ , The OVP is happened that OVP can be pull high, system can be control the output PMOS OFF and internal driver off.

**SENSE**

The Over Voltage sense pin, If  $V_{SENSE} > 1.23V$ , the OVP is happened that it can turn-off the driver. You can set  $V_{OUT}$  OVP voltage by outside resistances (R6 and R7).

**COMP**

The compensation pin. The COMP pin connects R5 and C5 to FB pin, The C5 use 47nF and R5 use 4.7K $\Omega$  for all condition.

❖ APPLICATION INFORMATION

**Setting the Output Voltage**

Application circuit item shows the basic application circuit with adjustable output version. The external resistor sets the output voltage according to the following equation:

$$V_{OUT} = 1.155V \times \left(1 + \frac{R1}{R2}\right)$$

Table 1 Resistor select for output voltage setting

V <sub>OUT</sub>	R2	R1
5.0V	1.5K	5K
3.27V	1.2K	2.2K

**Inductor Selection**

For most designs, the operates with inductors of 82μH to 100μH for AX3011. The inductor value can be derived from the following equation:

$$L = \frac{V_{OUT} \times (V_{IN} - V_{OUT})}{V_{IN} \times \Delta I_L \times f_{OSC}}$$

Where is inductor Ripple Current. Large value inductors lower ripple current and small value inductors result in high ripple currents. Choose inductor ripple current approximately 20% of the maximum load current 2A, ΔI<sub>L</sub>=0.4A. The DC current rating of the inductor should be at least equal to the maximum load current plus half the ripple current to prevent core saturation (2A+0.2A).

Please refer the recommend table for setting the inductor value:

L1 recommend value (V <sub>IN</sub> =12V ,I <sub>OUT</sub> =2A,)		
V <sub>OUT</sub>	3.3V	5V
L1 Value	82uH	100uH

### Input Capacitor Selection

This capacitor should be located close to the IC using short leads and the voltage rating should be approximately 1.5 times the maximum input voltage. The RMS current rating requirement for the input capacitor of a buck regulator is approximately 1/2 the DC load current. A low ESR input capacitor sized for maximum RMS current must be used. A 220μF low ESR capacitor for most applications is sufficient.

### Output Capacitor Selection

The output capacitor is required to filter the output and provide regulator loop stability. The important capacitor parameters are; the 100KHz Equivalent Series Resistance (ESR), the RMS ripples current rating, voltage rating, and capacitance value. For the output capacitor, the ESR value is the most important parameter. The ESR can be calculated from the following formula.

$$V_{RIPPLE} = \Delta I_L \times ESR = 0.4A \times 130m\Omega = 52mV$$

An aluminum electrolytic capacitor's ESR value is related to the capacitance and its voltage rating. In most case, higher voltage electrolytic capacitors have lower ESR values. Most of the time, capacitors with much higher voltage ratings may be needed to provide the low ESR values required for low output ripple voltage. It is recommended to replace this low ESR capacitor by using a 470μF low ESR values < 130mΩ.

### Thermal Considerations

The SOP-8L-EP package needs a heat sink under most conditions. The heat sink connect exposed pad of AX3011 to obtain best effect. The size of the heat sink depends on the input voltage, the output voltage, the load current and the ambient temperature. The AX3011 junction temperature rise above ambient temperature for a 2A load by different input and output voltages.

❖ TYPICAL CHARACTERISTICS

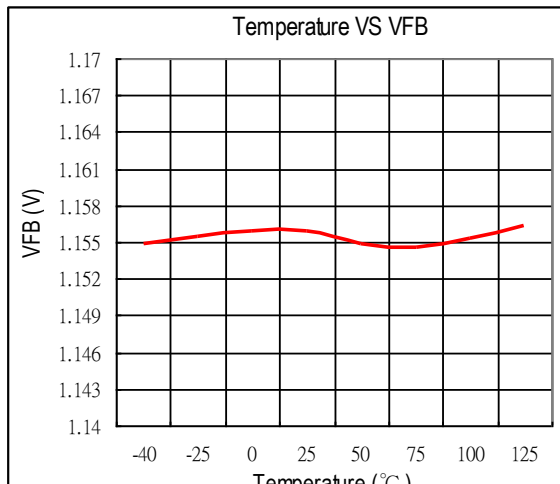
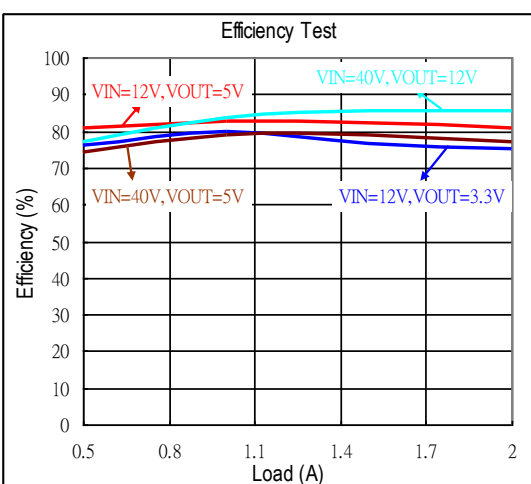
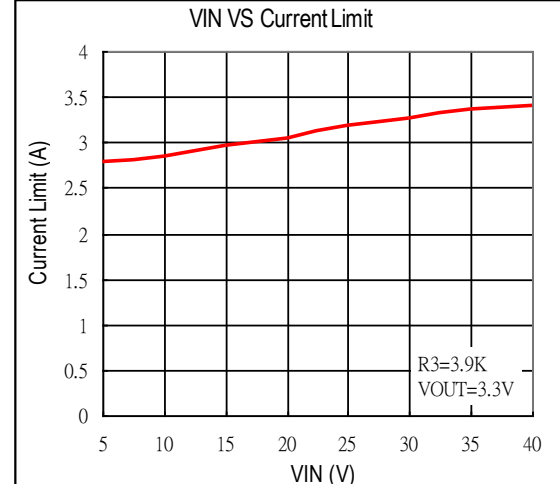
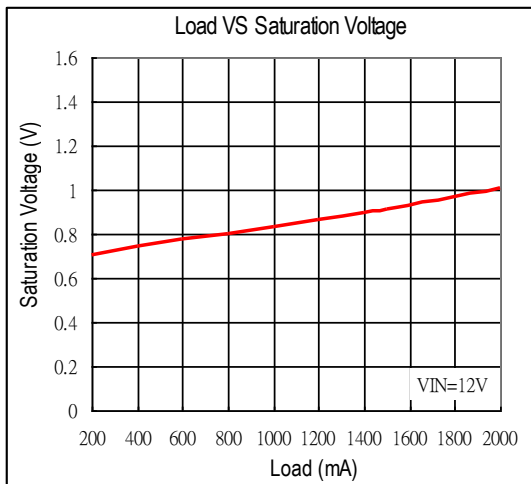
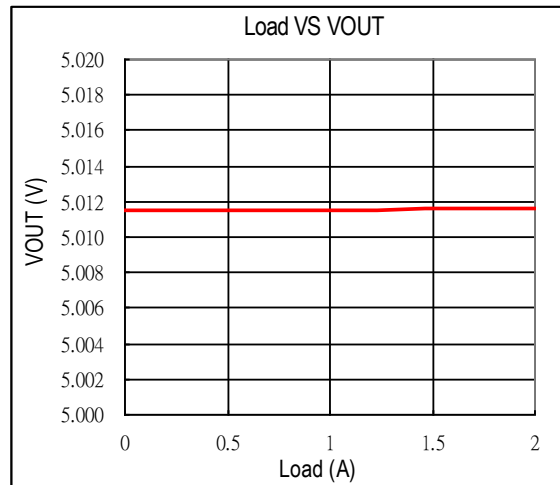
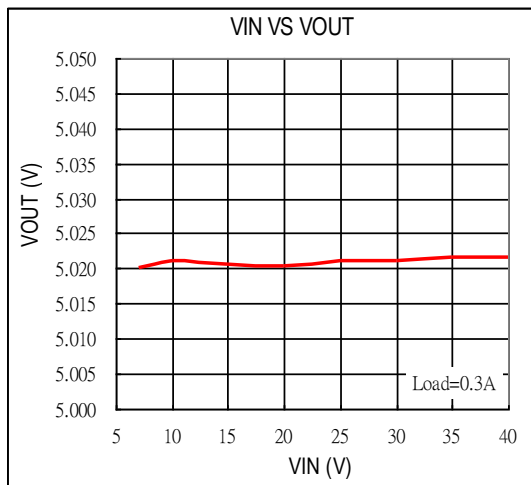



❖ TYPICAL CHARACTERISTICS (CONTINUES)

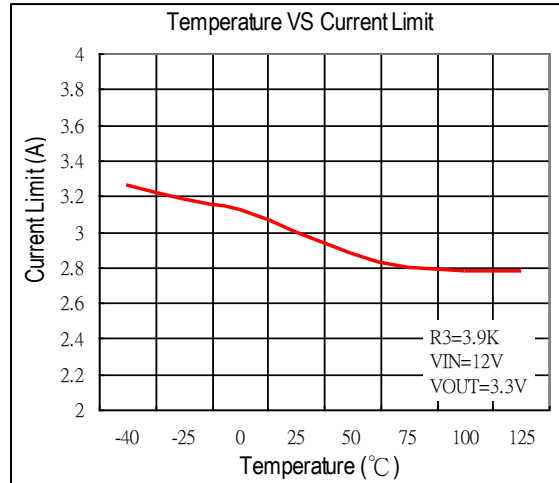
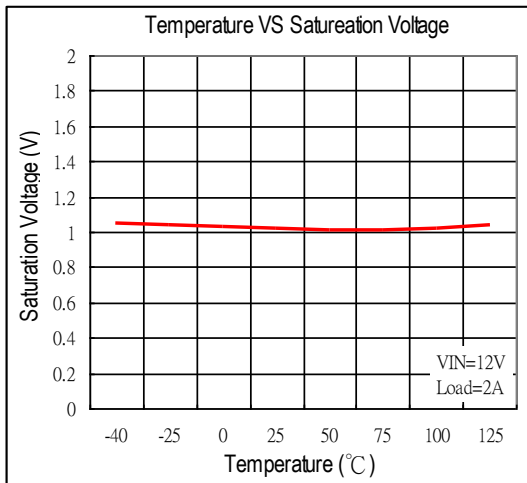

Load Transient  
(VIN=12V, VOUT=5V, Load=0.1~2A)

Load Transient  
(VIN=40V, VOUT=5V, Load=0.1~2A)

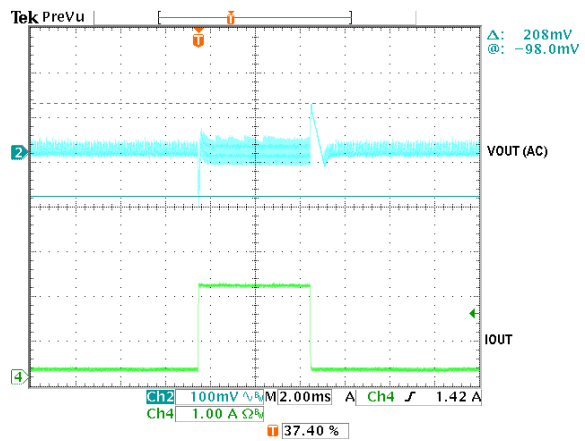
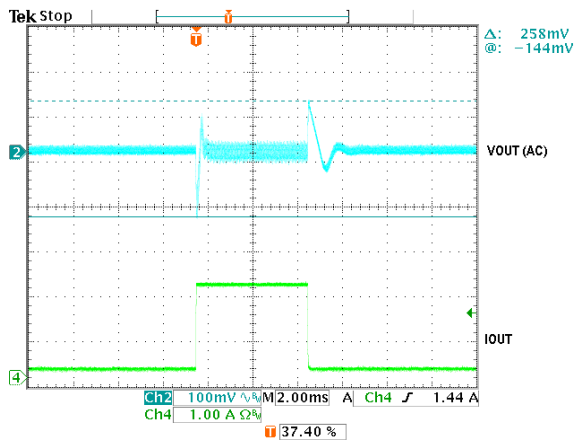

❖ PACKAGE OUTLINES

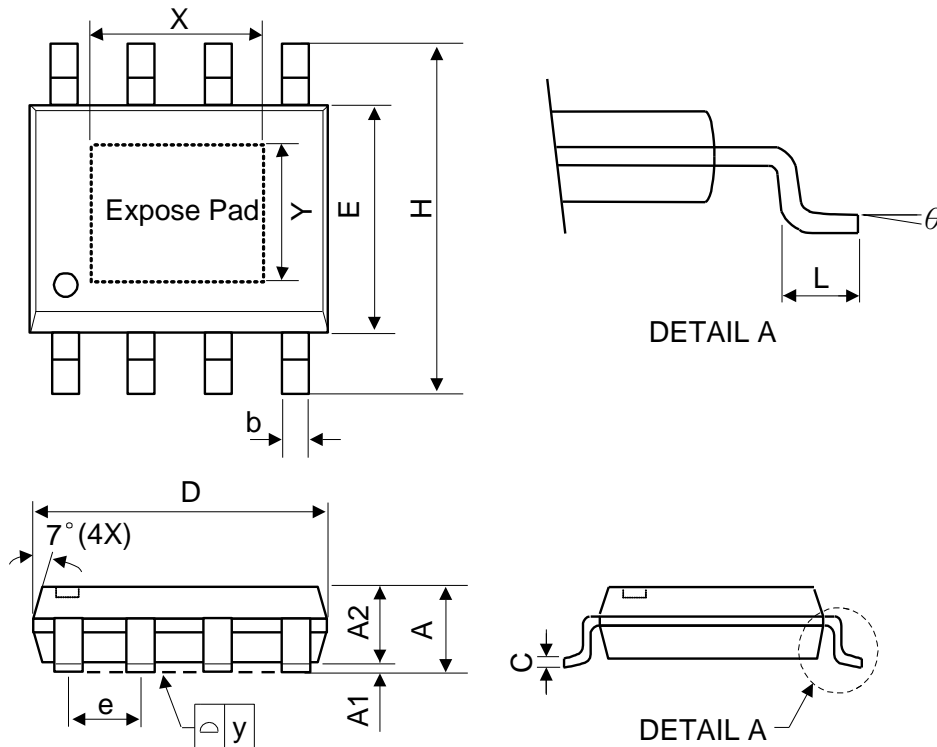

Symbol	Dimensions in Millimeters			Dimensions in Inches		
	Min.	Nom.	Max.	Min.	Nom.	Max.
A	-	-	1.75	-	-	0.069
A1	0	-	0.15	0	-	0.06
A2	1.25	-	-	0.049	-	-
C	0.1	0.2	0.25	0.0075	0.008	0.01
D	4.7	4.9	5.1	0.185	0.193	0.2
E	3.7	3.9	4.1	0.146	0.154	0.161
H	5.8	6	6.2	0.228	0.236	0.244
L	0.4	-	1.27	0.015	-	0.05
b	0.31	0.41	0.51	0.012	0.016	0.02
e	1.27 BSC			0.050 BSC		
y	-	-	0.1	-	-	0.004
X	-	2.34	-	-	0.092	-
Y	-	2.34	-	-	0.092	-
θ	0°	-	8°	0°	-	8°

Mold flash shall not exceed 0.25mm per side  
JEDEC outline: MS-012 BA