

PWM Control 2A Step-Down Converter

❖ GENERAL DESCRIPTION

AX3130 consists of step-down switching regulator with PWM control. These device include a reference voltage source, oscillation circuit, error amplifier, internal PMOS and etc.

AX3130 provides low-ripple power, high efficiency, and excellent transient characteristics. The PWM control circuit is able to the duty ratio linearly form 0 up to 100%. The converter frequency can be set by outside resistance. The wide range is from 200K to 1.3MHz. AX3130 is build out soft start function that prevent inrush current and overshooting. A shutdown switch, over current protect and short circuit protect functions are built inside, and when SCP happens, the operation frequency will be reduced to 150K. Also, an external compensation block is built in to good stable system.

With the addition of an internal P-channel Power MOS, a coil, capacitors, and a diode connected externally, these ICs can function as step-down switching regulators. They serve as ideal power supply units for portable devices when coupled with the SOP-8L and SOP-8L with exposed pad packages, providing such outstanding features as low current consumption. Since this converter can accommodate an input voltage up to 23V, it is also suitable for the operation via an AC adapter.

❖ FEATURES

- Input voltage : 4.5V to 23V
- Output voltage : V_{FB} to V_{CC}
- Duty ratio : 0% to 100% PWM control
- Oscillation frequency : 200K~1.3MHz (Outside resistance setting)
- Current Limit (CL), Short Current Protection (SCP)
- External Soft-Start function and Shutdown Function.
- Thermal Shutdown function.
- Built-in internal SW P-channel MOS.
- SOP-8L and SOP-8L with exposed pad Pb-Free packages.

❖ BLOCK DIAGRAM

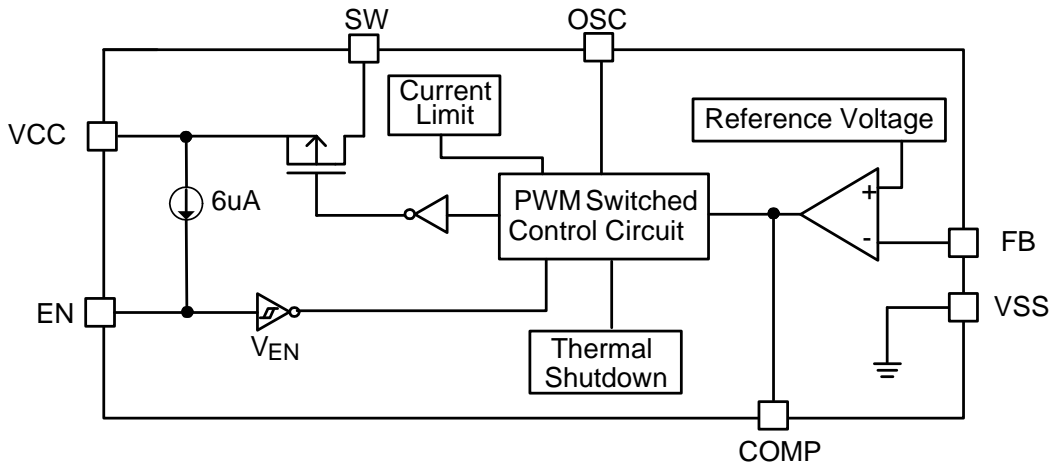

❖ PIN ASSIGNMENT

The packages of AX3130 are SOP-8L and SOP-8L-EP; the pin assignment is given by:

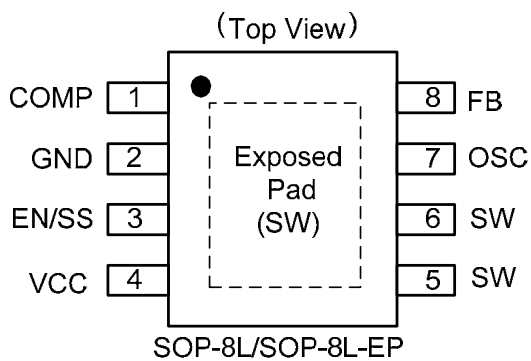

Name	Description
FB	Feedback pin
EN/SS	ON/OFF Shutdown and Soft-start pin
VCC	IC power supply pin
OSC	Frequency Set Pin. The pin connect a resistance to GND.
SW	Switch pin. Connect external inductor/diode here.
GND	GND pin
COMP	Compensation pin

❖ ORDER/MARKING INFORMATION

Order Information	Top Marking
<p>AX3130 XX X</p> <ul style="list-style-type: none"> Package Type: S: SOP-8L, ES: SOP-8L-EP Packing: Blank: Tube, A: Taping 	<p>Logo ← AX 3 1 3 0 → Part number YY WW X → ID code:internal WW: 01~52 Year: 10=2010, 11=2011</p>

❖ ABSOLUTE MAXIMUM RATINGS (at $T_A=25^{\circ}\text{C}$)

Characteristics	Symbol	Rating	Unit	
V_{CC} Pin Voltage	V_{CC}	$V_{SS} - 0.3$ to $V_{SS} + 25$	V	
Feedback Pin Voltage	V_{FB}	$V_{SS} - 0.3$ to 2.5	V	
EN/SS Pin Voltage	$V_{EN/SS}$	$V_{SS} - 0.3$ to 6	V	
Switch Pin Voltage	V_{SW}	$V_{SS} - 0.3$ to $V_{CC} + 0.3$	V	
COMP Pin Voltage	V_{COMP}	$V_{SS} - 0.3$ to 2.5	V	
OSC Pin Voltage	V_{OSC}	$V_{SS} - 0.3$ to 2.5	V	
Power Dissipation	PD	Internally limited	mW	
Storage Temperature Range	T_{ST}	-65 to +165	$^{\circ}\text{C}$	
Operating Junction Temperature	T_{OPJ}	-40 to +125	$^{\circ}\text{C}$	
Junction Temperature Range	T_J	-40 to +150	$^{\circ}\text{C}$	
Thermal Resistance from Junction to case	SOP-8L	θ_{JC}	35	$^{\circ}\text{C/W}$
	SOP-8L-EP		15	
Thermal Resistance from Junction to ambient	SOP-8L	θ_{JA}	100	$^{\circ}\text{C/W}$
	SOP-8L-EP		40	

Note: θ_{JA} is measured with the PCB copper area of approximately 1 in²(Multi-layer) to SW pin and exposed pad.

❖ ELECTRICAL CHARACTERISTICS ($V_{IN} = 12\text{V}$, $T_A=25^{\circ}\text{C}$, unless otherwise specified)

Characteristics	Symbol	Conditions	Min	Typ	Max	Units
Operating Supply Voltage	V_{CC}		4.5	-	23	V
Feedback Voltage	V_{FB}	$I_{OUT}=0.2\text{A}$	0.588	0.600	0.612	V
Quiescent Current	I_{CCQ}	$V_{FB}=1.2\text{V}$ force driver off	-	3	5	mA
Feedback Bias Current	I_{FB}	$I_{OUT}=0.2\text{A}$	-	0.1	0.5	μA
Shutdown Supply Current	I_{SD}	$V_{EN/SS}=0\text{V}$	-	150	200	μA
Line Regulation	V_{OUT}/V_{OUT}	$V_{IN}=4.5\text{V}\sim 23\text{V}$, $I_{OUT}=0.1\text{A}$	-	0.1	0.5	%
Load Regulation	V_{OUT}/V_{OUT}	$I_{OUT} = 0.1$ to 2A	-	0.3	0.6	%
Current Limit	I_{LIM}		2.5	-	-	A
Adjustable Frequency Range	$F_{OSC-ADJ}$		200	-	1300	KHz
Short Circuit Frequency	F_{OSC1}	$V_{FB}=0\text{V}$	-	150	-	KHz
EN/SS shutdown threshold voltage	V_{SHL}	Regulator OFF	-	-	0.4	V
EN/SS pull high Current	$I_{EN/SS}$	$V_{EN/SS}=0\text{V}$	-	6	-	μA
Internal P-MOSFET $R_{DS(ON)}$	R_{DS-ON}	$V_{IN}=5\text{V}$, $V_{FB}=0\text{V}$	-	90	-	m Ω
		$V_{IN}=12\text{V}$, $V_{FB}=0\text{V}$	-	60	-	
Thermal shutdown Temp	T_{SD}		-	140	-	$^{\circ}\text{C}$
Thermal Shutdown Hysteresis	T_{SH}		-	35	-	$^{\circ}\text{C}$

❖ APPLICATION CIRCUIT

(1) EL CAP :

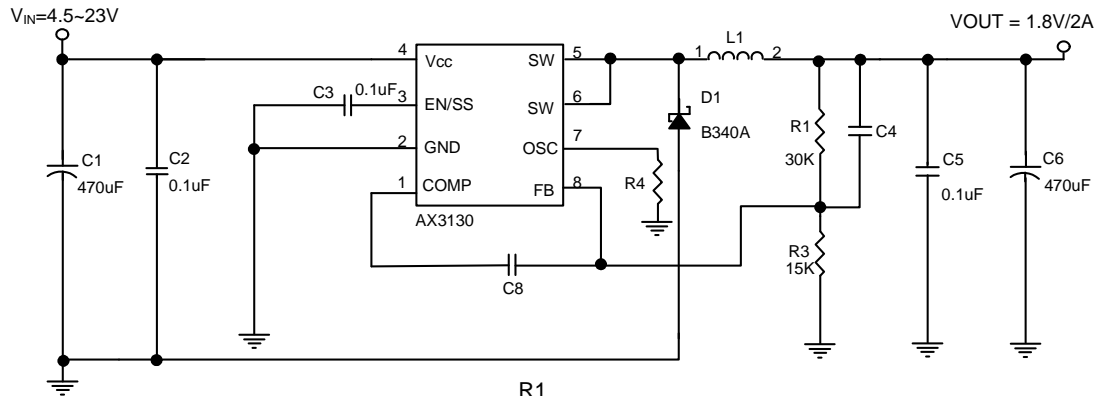

$$V_{OUT} = V_{FB} \times \left(1 + \frac{R1}{R3}\right)$$

V_{FB} = 0.6V ; R₃ suggest 10K ~ 20k

COUT ESR Range	Frequency (Hz)	V _{IN} Range	L1	C8	C4
30m~80mΩ	200K	4.5~23V	33u	68p	1800p
	400K		22u	47p	470p
	600K		15u	22p	100p
	800K		10u	22p	47p
	1M		6.8u	22p	22p
	1.2M		3.3u	22p	47p
80m~300mΩ	200K	4.5~23V	33u	68p	47p
	400K		22u	33p	47p
	600K		15u	22p	22p
	800K		105u	47p	22p
	1M		6.8u	22p	22p
	1.2M		3.3u	39p	22p

(2) Stable Range :

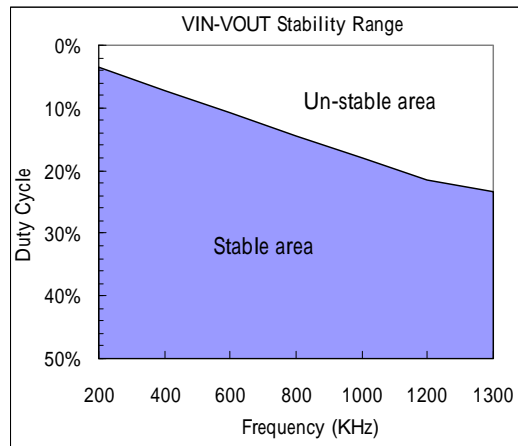

$$\text{DutyCycle}(\%) = \frac{V_{OUT}}{V_{IN}} \times 100$$

❖ FUNCTION DESCRIPTIONS

PWM Control

The AX3130 consists of DC/DC converters that employ a pulse-width modulation (PWM) system. In converters of the AX3130, the pulse width varies in a range from 0 to 100%, according to the load current. The ripple voltage produced by the switching can easily be removed through a filter because the switching frequency remains constant. The AX3130 frequency can be set by outside resistance that wide range from 200K to 1.3MHz. Therefore, these converters provide a low-ripple power over broad ranges of input voltage and load current.

Setting the Output Voltage

Application circuit item shows the basic application circuit with adjustable output version. The external resistor sets the output voltage according to the following equation:

$$V_{OUT} = 0.6V \times \left(1 + \frac{R1}{R3} \right)$$

Table 1 Resistor select for output voltage setting

V _{OUT}	R3	R1
5.0V	15K	110K
3.32V	15K	68K
2.48V	15K	47K
1.8V	15K	30K
1.5V	12K	18K
1.2V	15K	15K
1.0V	15K	10K

COMP

Compensation pin. For EL output capacitor application, the COMP pin connects C8 to FB for all condition; please refer the compensation table.

OSC

External frequency set pin. The pin connects a resistance (R4) to reduce system frequency. This converter's frequency can be set from 200K to 1.3MHz, please refer the below table to set frequency.

T=Room Temperature							
R4	V _{IN} =5V	444K	68K	32K	19K	12K	6K
()	V _{IN} =12V	540K	80K	36K	20K	12K	6K
Frequency (Hz)		200K	400K	600K	800K	1.0M	1.2M

EN/SS

This pin can be supplied shutdown or soft start function. It is inside pull high function. For normal application, the pin must be connected a capacitor to ground. There is a 6uA current to charge this capacitor, vary the different capacitor value to control soft start time. Allow the switching regulator circuit to be shutdown pulling this pin below a 0.4V threshold voltage; the shutdown supply current is approximately 150uA.

The soft-start time can be calculated by below formula, please refer the formula to design.

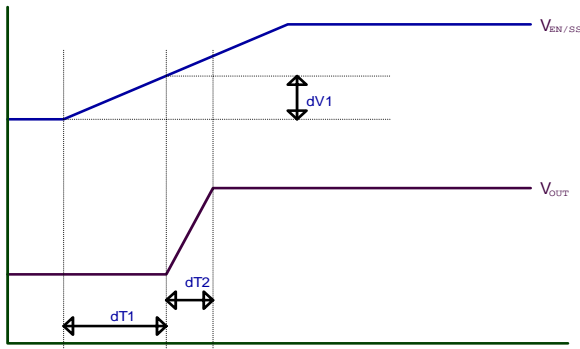

Calculate Start-up Delay Time (dT1)

$$\rightarrow dT1 = C3 \times dV1 \div I_{EN/SS1}$$

Where:

$$I_{EN/SS1} = 6\mu A$$

$$C3 = 10nF \sim 1000nF$$

$$dV1 = 0.76V \text{ (EN/SS VIH)}$$

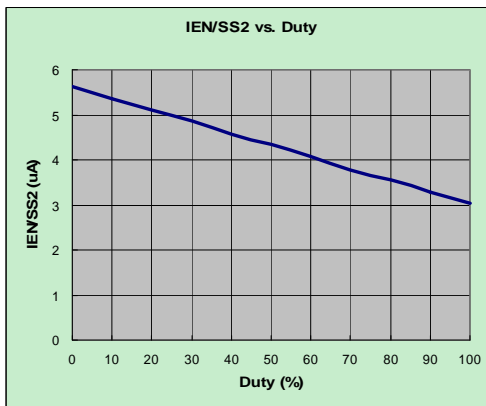
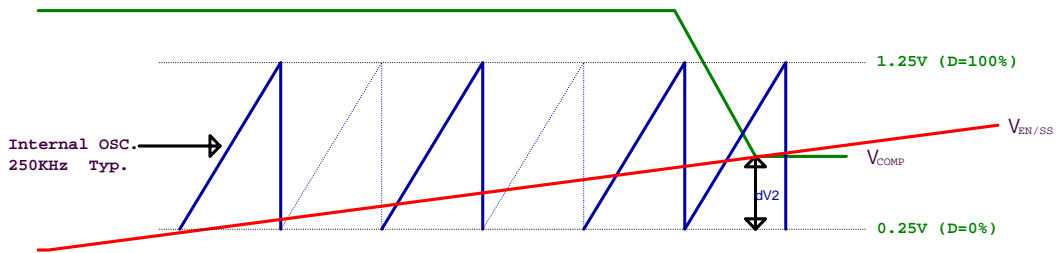

Calculate Soft Start Time (dT2)

$$dT2 = C3 \times dV2 \div I_{EN/SS2}$$

Where:

$$dV2 = (1.25 - 0.25) \times \text{Duty} = V_{OUT}/V_{IN} \text{ (V)}$$

$$I_{EN/SS2} = 5.64 - (5.64 - 3.03) \times dV2 \div (1.25 - 0.25)$$

$$= 5.64 - 2.61 \times V_{OUT}/V_{IN} \text{ (uA)}$$

$$\text{Duty (\%)} = V_{OUT}/V_{IN} \times 100$$

Example :

@ C3=100nF, V_{IN}=12V, V_{OUT}=2.5V, I_{OUT}=1A, EN-ON

$$dT1 = C3 \times dV1 \div I_{EN/SS1} = 100n \times 0.76 \div 6\mu = 12.67mS$$

$$dT2 = C3 \times dV2 \div I_{EN/SS2} = 100n \times 0.208 \div 5.1\mu = 4.08mS$$

Inductor Selection

For most designs, the different frequency can be reducing the inductor value; it is suggested 3.3μH to 33μH for 1.3M to 200K frequency. Please refer the below table to design.

L1 recommend value (V _{IN} =12V, V _{OUT} =3.3V, I _{OUT} =2A)						
Frequency (Hz)	200K	400K	600K	800K	1M	1.2M
L1 Value	33u	22u	15u	10u	6.8u	3.3u

Where is inductor Ripple Current. Large value inductors lower ripple current and small value inductors result in high ripple currents. Choose inductor ripple current approximately 15% of the maximum load current 2A, $\Delta I_L=0.3A$. The DC current rating of the inductor should be at least equal to the maximum load current plus half the ripple current to prevent core saturation (2A+0.15A).

Input Capacitor Selection

The input capacitor reduces the surge current drawn from the input and switching noise from the device. The input capacitor impedance at the switching frequency shall be less than input source impedance to prevent high frequency switching current passing to the input. A low ESR input capacitor sized for maximum RMS current must be used.

The capacitor voltage rating should be at least 1.5 times greater than the input voltage, and often much higher voltage ratings are needed to satisfy.

Output Capacitor Selection

The output capacitor is required to keep the output voltage ripple small and to ensure regulation loop stability. The output capacitor must have low impedance at the switching frequency. A low ESR capacitor sized for maximum RMS current must be used. The low ESR requirements needed for low output ripple voltage.

The capacitor voltage rating should be at least 1.5 times greater than the input voltage, and often much higher voltage ratings are needed to satisfy.

Layout Guidance (please refer layout picture)

When laying out the PC board, the following suggestions should be taken to ensure proper operation of the AX3130. These items are also illustrated graphically in below.

1. The power traces, including the source trace, the output trace and the inductor trace should be kept short, direct and wide to allow large current flow.
2. The power ground (D1's ground) is closed to input capacitor's (C1) ground and far away signal ground.
3. C2 bypass capacitor's ground must connect to IC's ground closely.
4. Do not trace signal line under inductor.

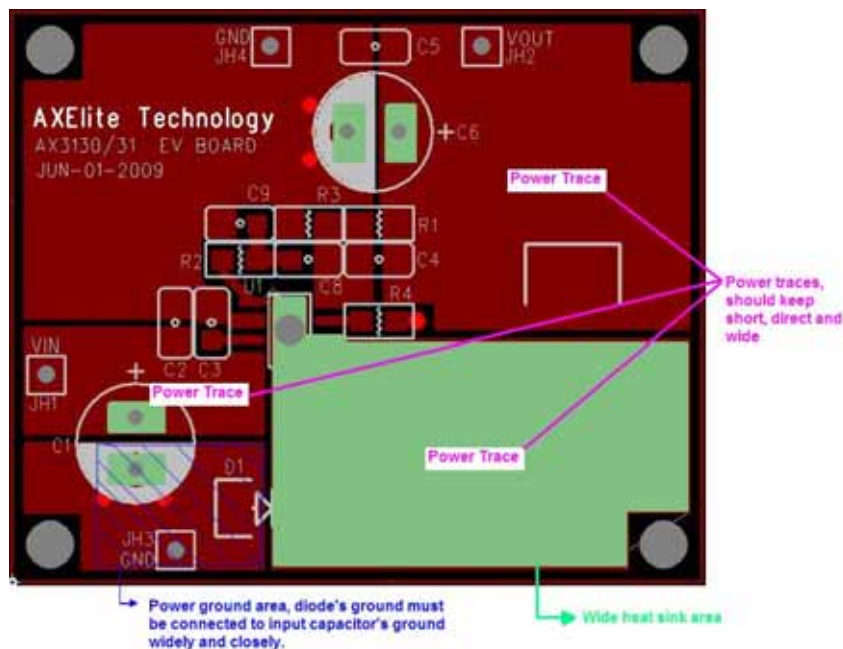

AX3130 PCB Layout – Top layer

❖ TYPICAL CHARACTERISTICS

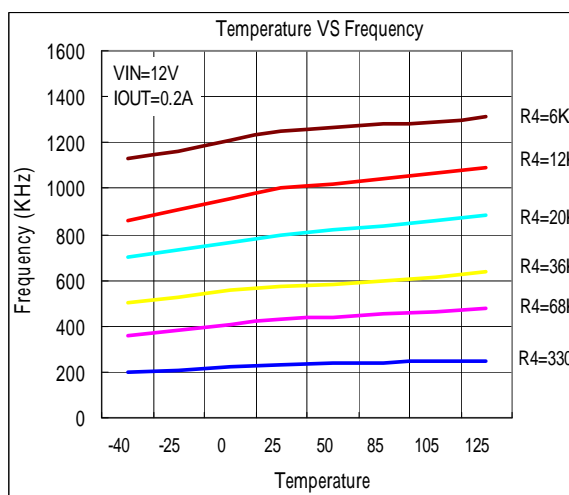
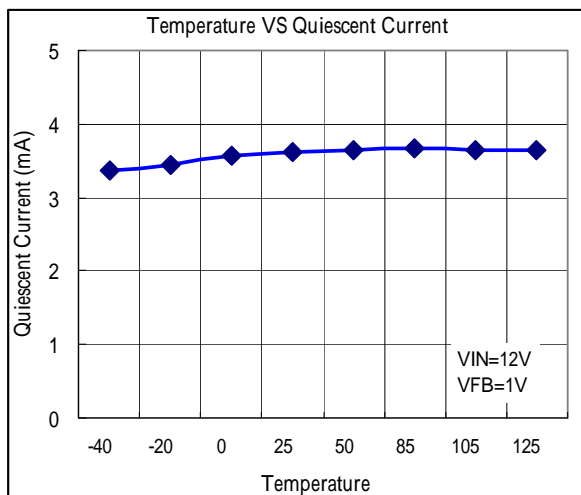
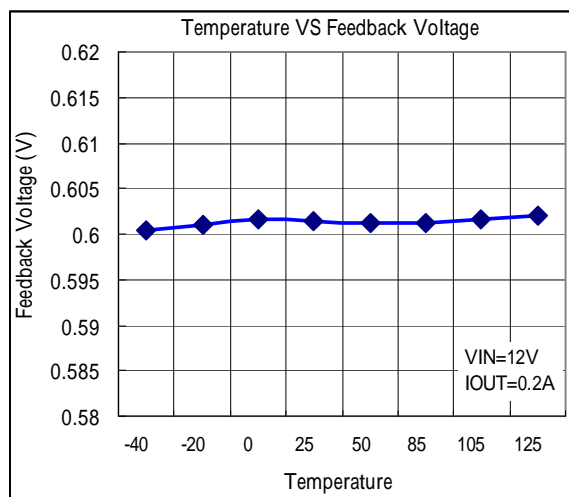
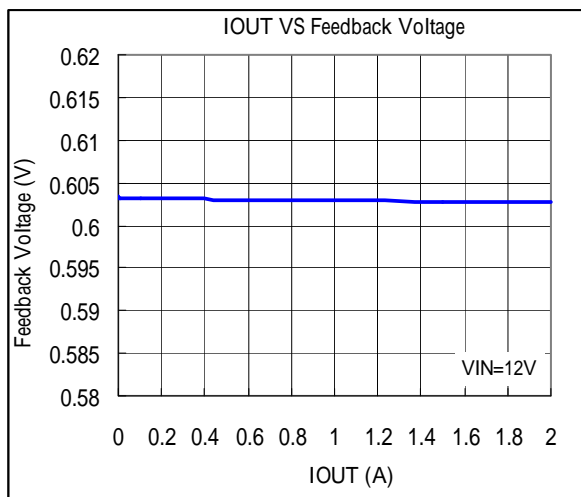
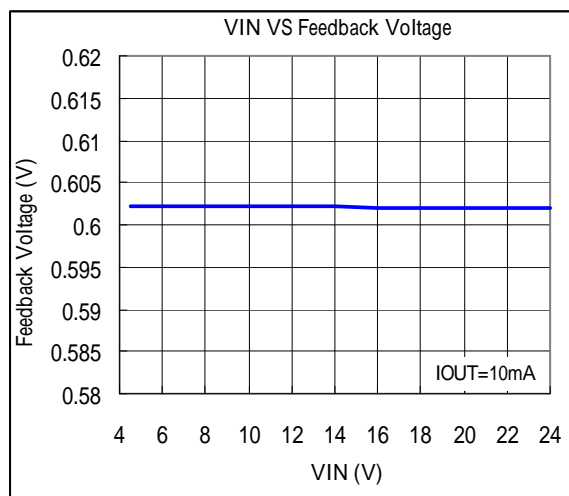
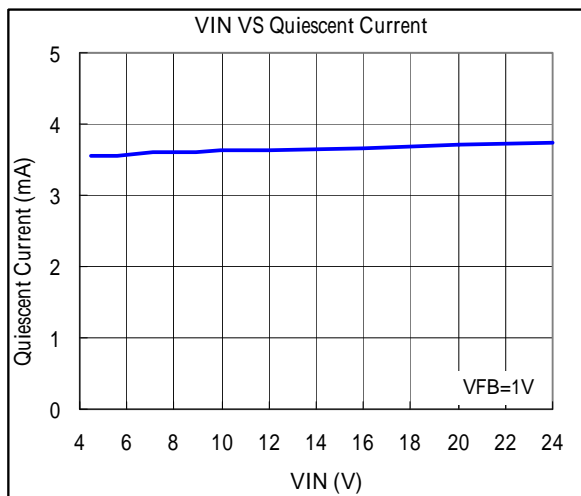

❖ TYPICAL CHARACTERISTICS (CONTINUOUS)

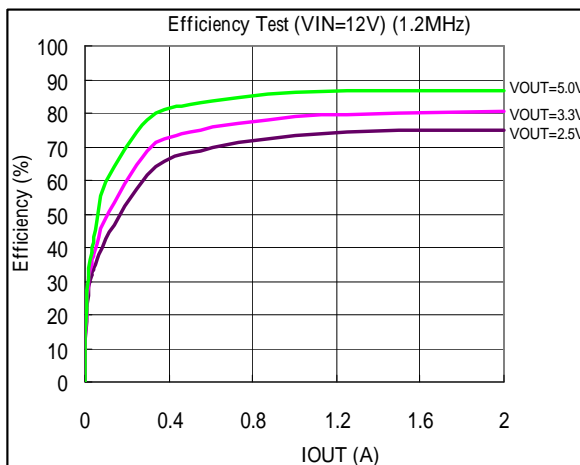
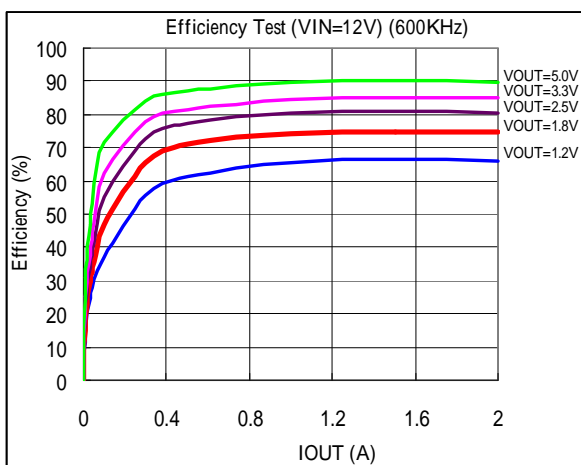
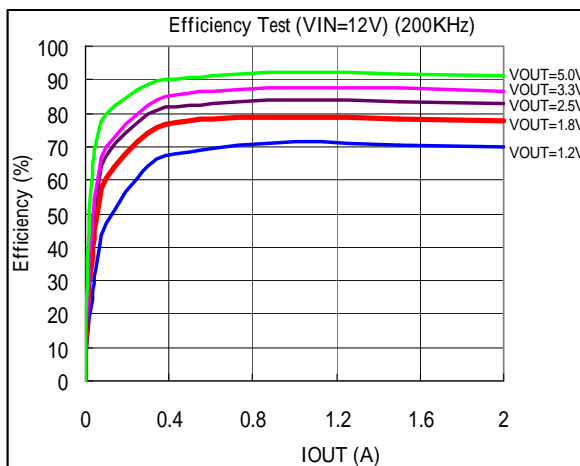
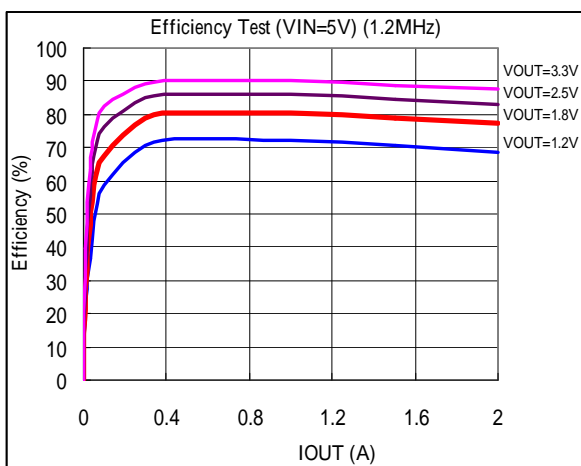
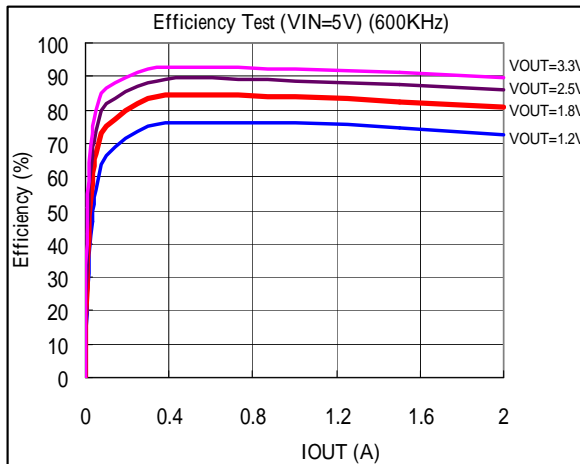
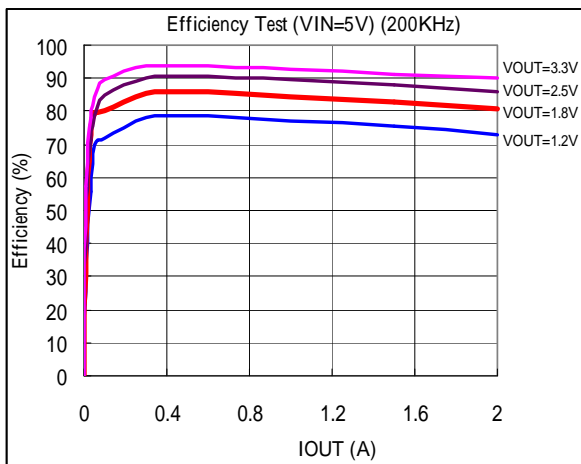

❖ TYPICAL CHARACTERISTICS (CONTINUOUS)

Power-ON Wave (F=200KHz)
($V_{IN}=12V$, $V_{OUT}=2.5V$, Load=1A, $C_{EN/SS}=10nF$)

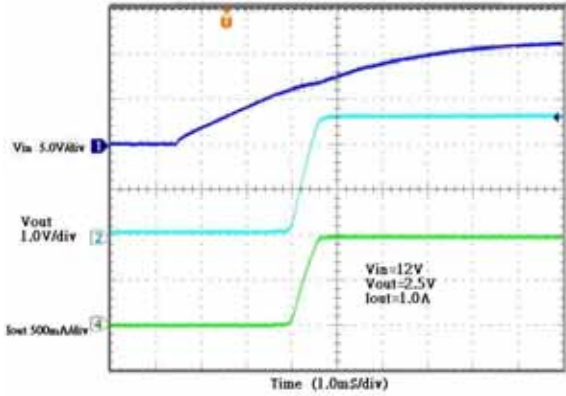

Power-ON Wave (F=600KHz)
($V_{IN}=12V$, $V_{OUT}=2.5V$, Load=1A, $C_{EN/SS}=10nF$)

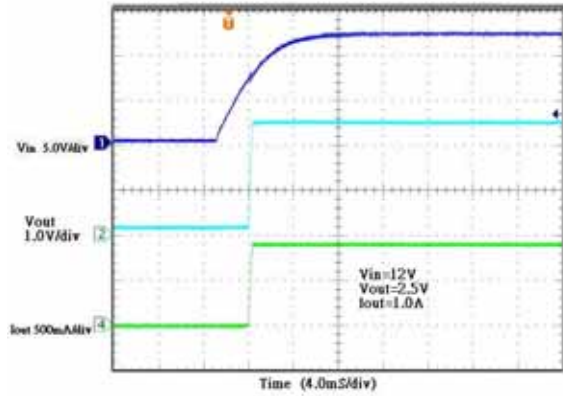

Power-ON Wave (F=1.2MHz)
($V_{IN}=12V$, $V_{OUT}=2.5V$, Load=1A, $C_{EN/SS}=10nF$)

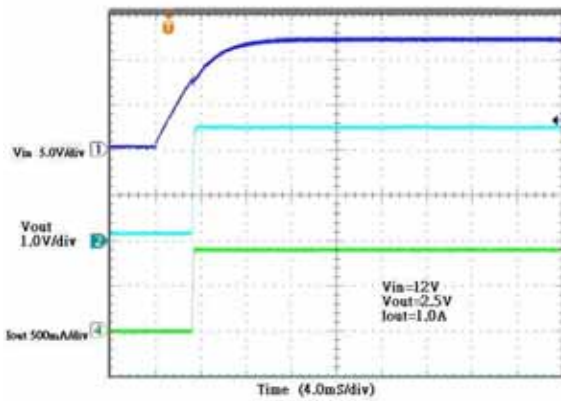

Enable-ON Wave (200KHz)
($V_{IN}=12V$, $V_{OUT}=2.5V$, Load=0.5A, $C_{EN/SS}=10nF$)

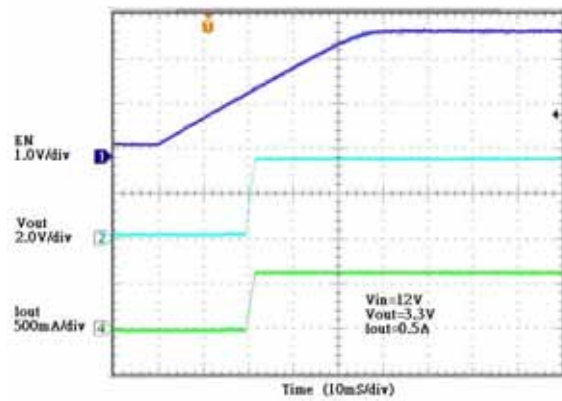

Enable-ON Wave (600KHz)
($V_{IN}=12V$, $V_{OUT}=2.5V$, Load=0.5A, $C_{EN/SS}=10nF$)

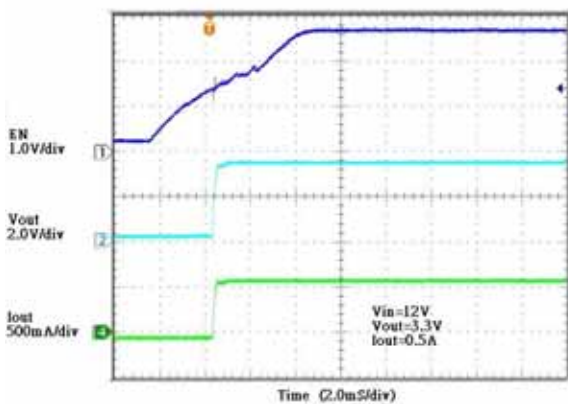

Enable-ON Wave (1.2MHz)
($V_{IN}=12V$, $V_{OUT}=2.5V$, Load=0.5A, $C_{EN/SS}=10nF$)

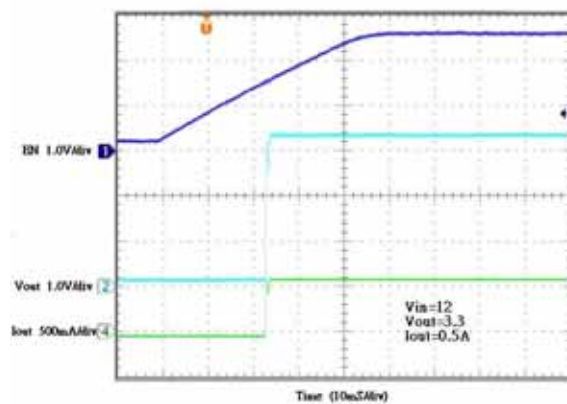

❖ TYPICAL CHARACTERISTICS (CONTINUOUS)

Load Transient (F=200KHz)
 (V_{IN}=12V, V_{OUT}=2.5V, Load=0.2~2A)

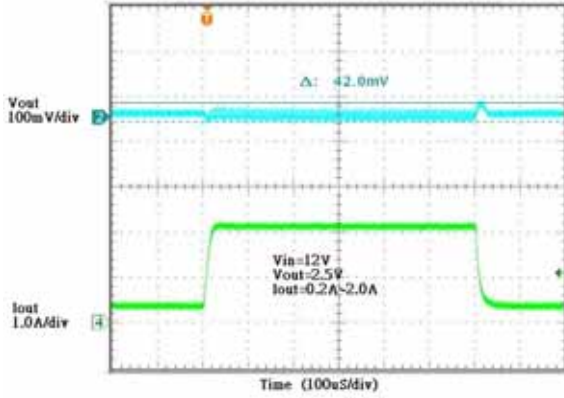

Load Transient (F=600KHz)
 (V_{IN}=12V, V_{OUT}=2.5V, Load=0.2~2A)

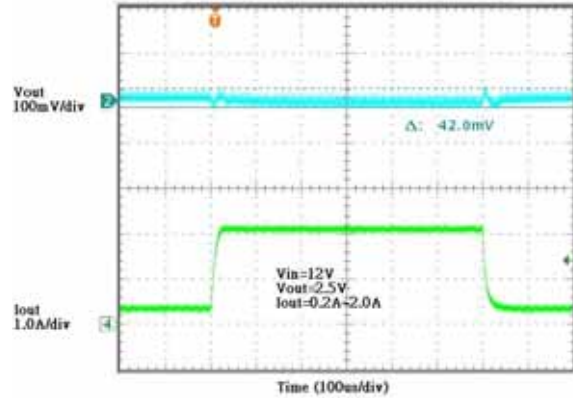

Load Transient (F=1.2MHz)
 (V_{IN}=12V, V_{OUT}=2.5V, Load=0.2~2A)

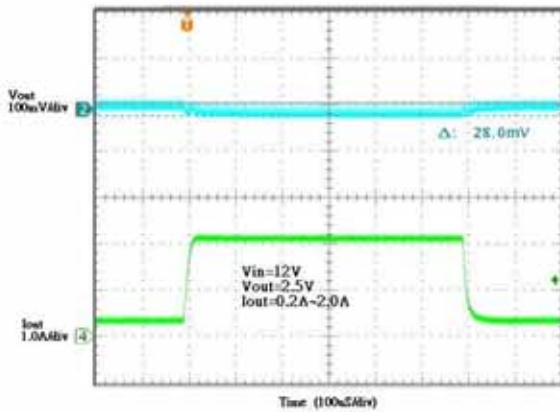

❖ PACKAGE OUTLINES

(1) SOP-8L

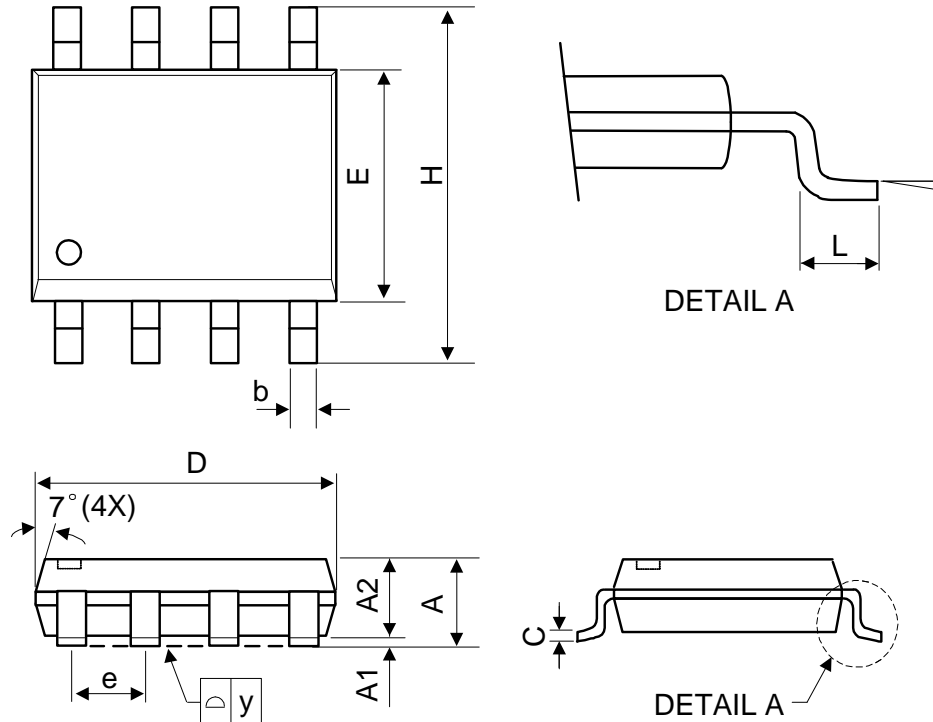

Symbol	Dimensions in Millimeters			Dimensions in Inches		
	Min.	Nom.	Max.	Min.	Nom.	Max.
A	-	-	1.75	-	-	0.069
A1	0.1	-	0.25	0.04	-	0.1
A2	1.25	-	-	0.049	-	-
C	0.1	0.2	0.25	0.0075	0.008	0.01
D	4.7	4.9	5.1	0.185	0.193	0.2
E	3.7	3.9	4.1	0.146	0.154	0.161
H	5.8	6	6.2	0.228	0.236	0.244
L	0.4	-	1.27	0.015	-	0.05
b	0.31	0.41	0.51	0.012	0.016	0.02
e	1.27 BSC			0.050 BSC		
y	-	-	0.1	-	-	0.004
	0°	-	8°	0°	-	8°

Mold flash shall not exceed 0.25mm per side

JEDEC outline: MS-012 AA

(2) SOP-8L-EP

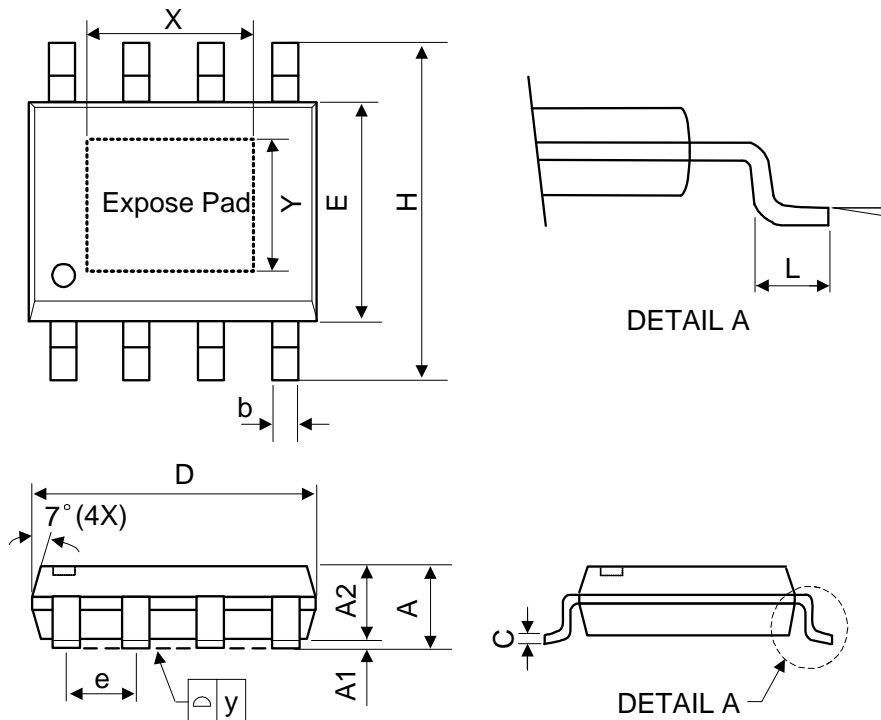

Symbol	Dimensions in Millimeters			Dimensions in Inches		
	Min.	Nom.	Max.	Min.	Nom.	Max.
A	-	-	1.75	-	-	0.069
A1	0	-	0.15	0	-	0.06
A2	1.25	-	-	0.049	-	-
C	0.1	0.2	0.25	0.0075	0.008	0.01
D	4.7	4.9	5.1	0.185	0.193	0.2
E	3.7	3.9	4.1	0.146	0.154	0.161
H	5.8	6	6.2	0.228	0.236	0.244
L	0.4	-	1.27	0.015	-	0.05
b	0.31	0.41	0.51	0.012	0.016	0.02
e	1.27 BSC			0.050 BSC		
y	-	-	0.1	-	-	0.004
X	-	2.34	-	-	0.092	-
Y	-	2.34	-	-	0.092	-
θ	0°	-	8°	0°	-	8°

Mold flash shall not exceed 0.25mm per side
JEDEC outline: MS-012 BA