

PWM Step-Down Controller

❖ GENERAL DESCRIPTION

The AX3301 integrates Pulse-Width-Modulation (PWM) control circuit into a single chip. These device include a reference voltage source, oscillation circuit, error amplifier and etc.

AX3301 provides low-ripple power, high efficiency, and excellent transient characteristics. The PWM control circuit is able to the duty ratio linearly form 0 up to 100%. An enable function, an over current protect function and short circuit protect function are built inside, and when OCP or SCP happens, the operation frequency will be reduced.

With the addition of an external P-channel Power MOS, a coil, capacitors, and a diode connected externally, these components can function as step-down switching regulators. They serve as ideal power supply units for portable devices when coupled with the SOP-8L and MSOP-8L mini-package, providing such outstanding features as low current consumption. Since this converter can accommodate an input voltage up to 24V, it is also suitable for the operation via an AC adapter.

❖ FEATURES

- Input voltage : 4V to 24V
- Output voltage : 0.8V to V_{CC}
- Duty ratio : 0% to 100% PWM control
- Oscillation frequency : 330KHz typ.
- Current Limit (CL), Enable function.
- Thermal Shutdown function.
- Short Circuit Protect (SCP).
- External SW P-channel MOS.
- MSOP-8L and SOP-8L Pb-Free packages.

❖ BLOCK DIAGRAM

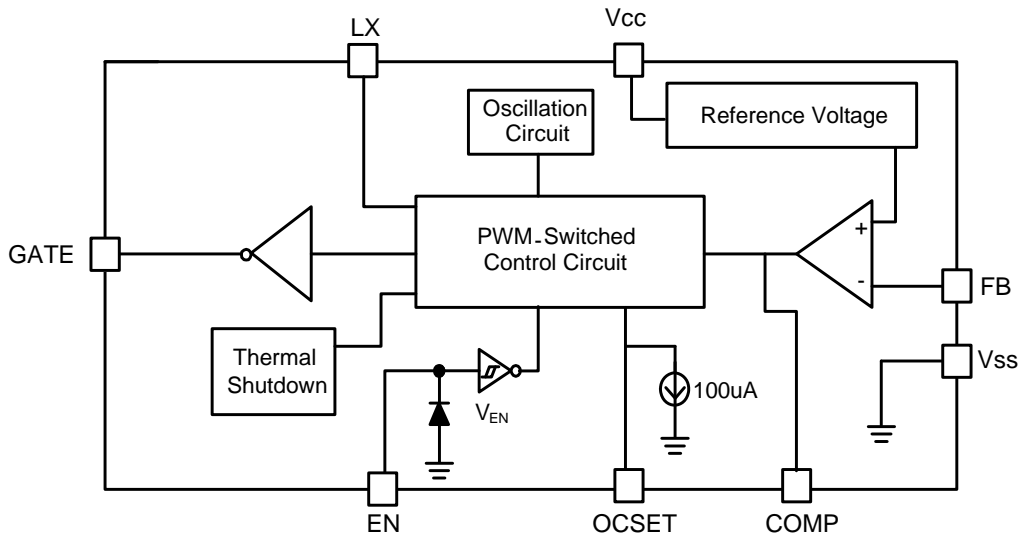

❖ PIN ASSIGNMET

These packages of AX3301 are MSOP-8L and SOP-8L; the pin assignment is given by:

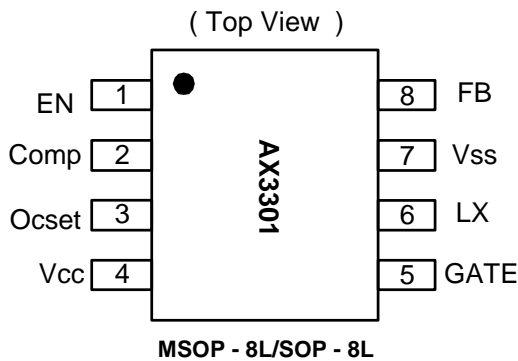

Name	Description
EN	Shutdown Control Input. H : normal operation(Step-down) L : Shutdown mode
Comp	Compensation pin
OCSET	Add an external resistor to set max switch output current.
V _{CC}	IC power supply pin
GATE	Gate drive for external P-channel MOSFET.
LX	LX is the current sense input.
V _{SS}	GND pin
FB	Feedback pin

❖ ORDER/MARKING INFORMATION

Order Information	Top Marking
<p>AX3301 X XX X</p> <p>Frequency Package Type Packing Blank : 330Khz S: SOP-8L Blank : Tube U8:MSOP-8L A : Taping</p>	<p>Logo ← AX 3 3 0 1 → Part number YY WW X → ID code:internal → WW:01~52 → Year: 10=2010 11=2011</p>

❖ ABSOLUTE MAXIMUM RATINGS (at $T_A=25^{\circ}\text{C}$)

Characteristics	Symbol	Rating	Unit
VCC Pin Voltage	V_{CC}	$V_{SS} - 0.3$ to $V_{SS} + 26$	V
Feedback Pin Voltage	V_{FB}	$V_{SS} - 0.3$ to V_{CC}	V
ON/OFF Pin Voltage	V_{EN}	$V_{SS} - 0.3$ to $V_{CC} + 0.3$	V
LX Voltage	V_{LX}	$V_{SS} - 0.3$ to $V_{CC} + 0.3$	V
Power Dissipation	PD	Internally limited	mW
Storage Temperature Range	T_{ST}	-40 to +150	$^{\circ}\text{C}$
Operating Junction Temperature Range	T_J	-20 to +125	$^{\circ}\text{C}$
Operating Supply Voltage	V_{OP}	+4 to +24	V
Thermal Resistance from Junction to case	SOP-8L	θ_{JC}	$^{\circ}\text{C/W}$
	MSOP-8L		
Thermal Resistance from Junction to ambient	SOP-8L	θ_{JA}	$^{\circ}\text{C/W}$
	MSOP-8L		

Note: θ_{JA} is measured with the PCB copper area of approximately 1 in²(Multi-layer).

❖ ELECTRICAL CHARACTERISTICS

($V_{IN} = 12\text{V}$, $T_A = 25^{\circ}\text{C}$, unless otherwise specified)

Characteristics	Symbol	Conditions	Min	Typ	Max	Units	
Feedback Voltage	V_{FB}	$I_{OUT}=0.1\text{A}$	0.784	0.800	0.816	V	
Quiescent Current	I_{CCQ}	$V_{FB}=1.2\text{V}$ force driver off		3	5	mA	
Feedback Bias Current	I_{FB}	$I_{OUT}=0.1\text{A}$	-	0.1	0.5	μA	
Shutdown Supply Current	I_{SD}	$V_{EN}=0\text{V}$	-	2	10	μA	
OCSET pin bias current	I_{OCSET}		110	130	150	μA	
Line Regulation	$\Delta V_{OUT}/V_{OUT}$	$V_{IN} = 5\text{V}\sim 24\text{V}$, $I_{OUT}=0.2\text{A}$	-	0.6	1.2	%	
Load Regulation	$\Delta V_{OUT}/V_{OUT}$	$I_{OUT} = 0.1$ to 3A	-	0.3	0.5	%	
Oscillation Frequency	F_{OSC}	LX pin	260	330	400	KHz	
EN Pin Logic input threshold voltage	V_{SH}	High (regulator ON)	2.0	-	-	V	
	V_{SL}	Low (regulator OFF)	-	-	0.8		
EN Pin Input Current	I_{SH}	$V_{EN}=2.5\text{V}$ (ON)	-	20	-	μA	
	I_{SL}	$V_{EN}=0.3\text{V}$ (OFF)	-	-10	-	μA	
LX Rise Time	T_{LXR}	$C_{LX}=1000\text{pF}$	-	45	-	nS	
LX Fall Time	T_{LXF}	$C_{LX}=1000\text{pF}$	-	45	-		
Efficiency	EFFI	$V_{OUT} = 5\text{V}$	$I_{OUT} = 2\text{A}$	-	92	-	%
			$I_{OUT} = 3\text{A}$	-	91	-	
Thermal shutdown Temp	T_{SD}			125		$^{\circ}\text{C}$	

❖ APPLICATION CIRCUIT

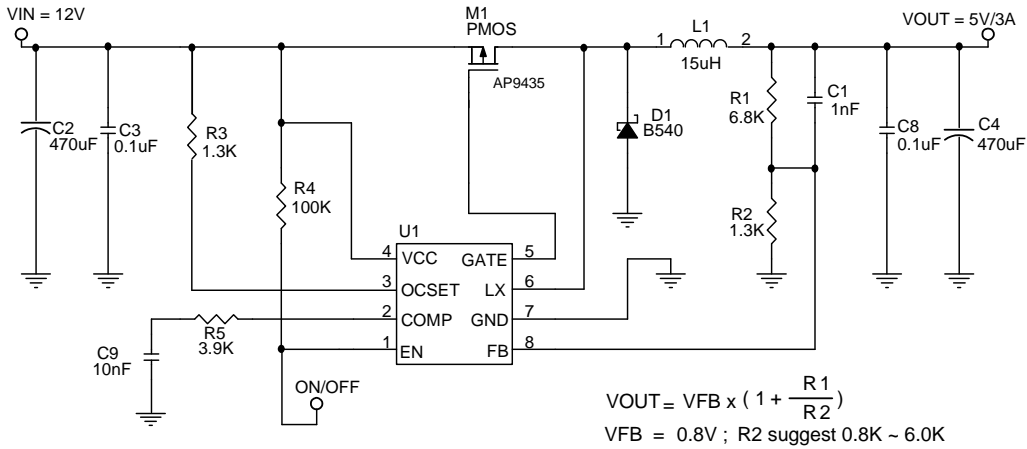

Compensation Capacitor Selection				
VIN	VOUT	R5	C9	C1
5-24V	5/3.3/2.5/1.8V	3.9K	10nF	1nF

❖ FUNCTION DESCRIPTIONS

PWM Control

The AX3301 integrates Pulse-Width-Modulation (PWM) control circuit into a single chip. The pulse width varies in a range from 0 to 100%, according to the load current. The ripple voltage produced by the switching can easily be removed through a filter because the switching frequency remains constant. Therefore, these controllers provide a low-ripple power over broad ranges of input voltage and load current.

RDS (ON) Current Limiting

The current limit threshold is setting by the external resistor (R3) connecting from V_{CC} supply to OCSET pin. The internal 110uA sink current crossing the resistor sets the voltage at pin of OCSET. When the PWM voltage is less than the voltage at OCSET, an over-current condition is triggered. Please refer to the formula for setting the current limit value

$$I_{SW(MAX)} = \frac{I_{OCSET} \times R3 + 0.075}{R_{DS(ON)}}$$

(Normally, The I_{SW(MIN)} setting more than I_{OUT} 1.0A).

Example:

$$I_{SW} = (110\mu A * 1.3k + 0.075) / 50m\Omega \text{ (AM9435GM SPEC)} = 4.36A \text{ (VIN=12V)}$$

Setting the Output Voltage

Application circuit item shows the basic application circuit with AX3301 adjustable output version. The external resistor sets the output voltage according to the following equation:

$$V_{OUT} = 0.8V \times \left(1 + \frac{R1}{R2}\right)$$

Table 1 Resistor select for output voltage setting

V _{OUT}	R2	R1
5V	1.3K	6.8K
	5.6K	30K
3.3V	1.5K	4.7K
	5.6K	18K
2.5V	2.2K	4.7K
	5.6K	12K
1.8V	1.2K	1.5K
1.5V	2.2K	2.0K

Inductor Selection

For most designs, Low inductance values are physically smaller but require faster switching, which results in some efficiency loss. The inductor value can be derived from the following equation:

$$L = \frac{V_{OUT} \times (V_{IN} - V_{OUT})}{V_{IN} \times \Delta I_L \times f_{LX}}$$

Where is inductor Ripple Current. Large value inductors lower ripple current and small value inductors result in high ripple currents. Choose inductor ripple current approximately 15% of the maximum input current 3A, ΔI_L=0.45A.

Table 2 Inductor select for output voltage setting (AX3301 at V_{IN}=12V)

V _{OUT}	2.5V(3A)	3.3V(3A)	5V(3A)	3.3V(5A)	5V(5A)
L1 Value	15uH	18uH	22uH	12uH	15uH

The DC current rating of the inductor should be at least equal to the maximum load current plus half the ripple current to prevent core saturation (3A+0.25A).

Input Capacitor Selection

This capacitor should be located close to the IC using short leads and the voltage rating should be approximately 1.5 times the maximum input voltage. The RMS current rating requirement for the input capacitor of a buck regulator is approximately 1/2 the DC load current. A low ESR input capacitor sized for maximum RMS current must be used. A 220 μ F low ESR capacitor for most applications is sufficient.

Output Capacitor Selection

The output capacitor is required to filter the output and provide regulator loop stability. The important capacitor parameters are; the 100KHz Equivalent Series Resistance (ESR), the RMS ripples current rating, voltage rating, and capacitance value. For the output capacitor, the ESR value is the most important parameter. The ESR can be calculated from the following formula.

$$V_{RIPPLE} = \Delta I_L \times ESR = 0.4A \times 110m\Omega = 44mV$$

An aluminum electrolytic capacitor's ESR value is related to the capacitance and its voltage rating. In most case, higher voltage electrolytic capacitors have lower ESR values. Most of the time, capacitors with much higher voltage ratings may be needed to provide the low ESR values required for low output ripple voltage. It is recommended to replace this low ESR capacitor by using a 330 μ F low ESR values < 110m Ω .

Layout Guidance

When laying out the PC board, the following suggestions should be taken to ensure proper operation of the AX3301. These items are also illustrated graphically in below.

1. The power traces, including the PMOS Drain and Source trace, the Schottky and the C2 trace should be kept short, direct and wide to allow large current flow.
2. Keep the switching node, away from the sensitive FB node.
3. Connect ground side of the C2 and D1 as closely as possible.
4. Connect PMOS Source and R3 as closely as possible.
5. Do not trace signal line under inductor.

❖ TYPICAL CHARACTERISTICS

VFB VS VIN

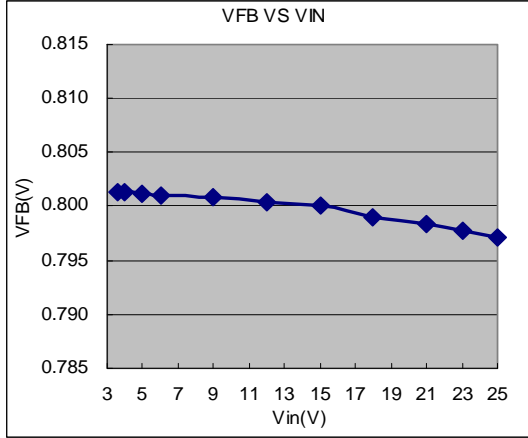

ICCQ VS VIN

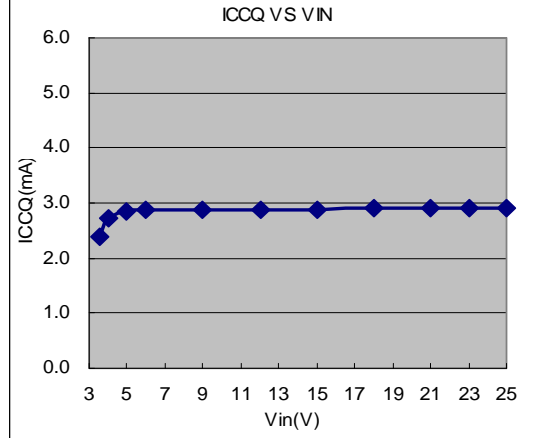

IOCSET VS VIN

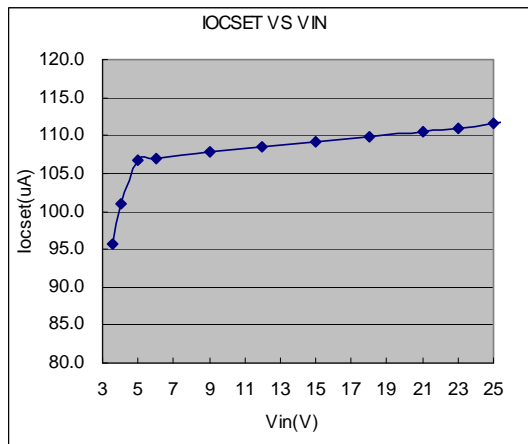

FOSC VS VIN

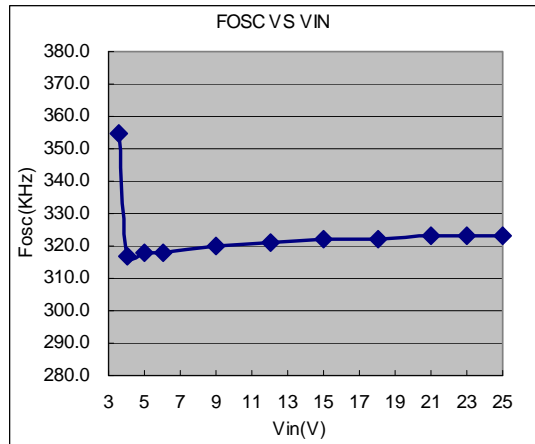

VFB VS TEMPERATURE

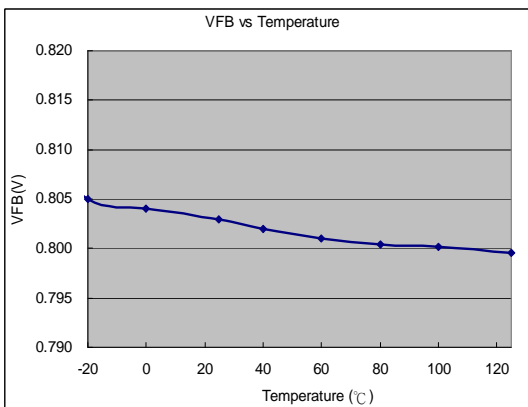

ICCQ VS TEMPERATURE

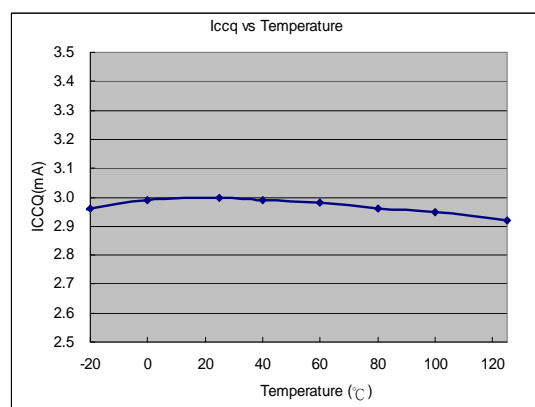

❖ TYPICAL CHARACTERISTICS (CONTINUOUS)

IOCSET VS TEMPERATURE

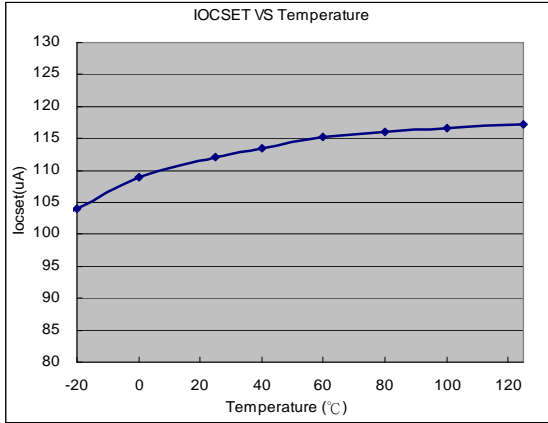

FOSC VS TEMPERATURE

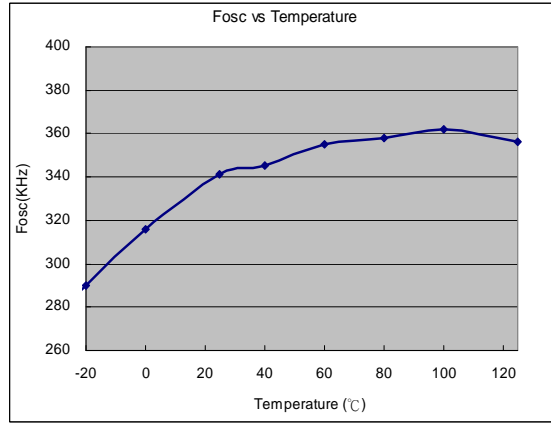

Efficiency ($V_{IN}=12V, V_{OUT}=5V$)

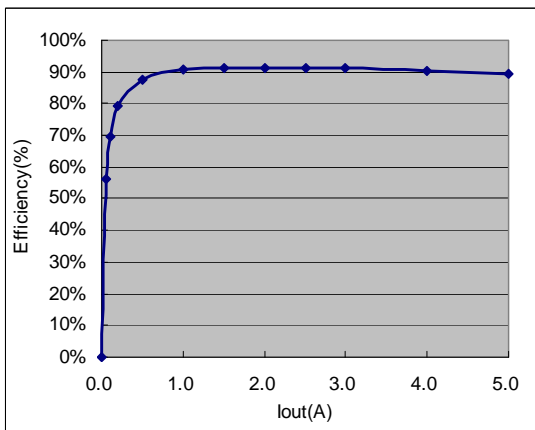

Efficiency ($V_{IN}=12V, V_{OUT}=3.3V$)

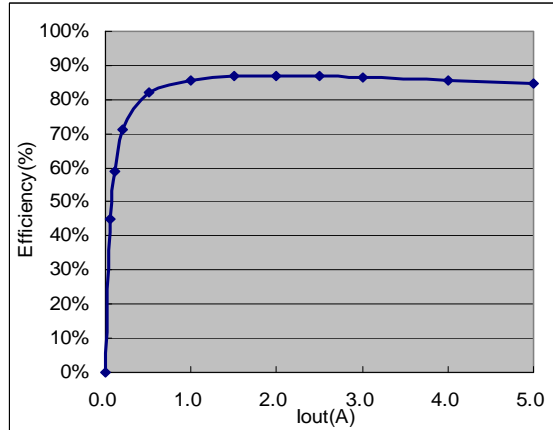

IOCSET VS TEMPERATURE

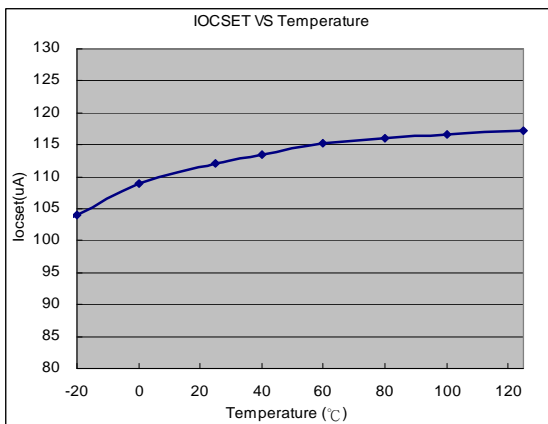

FOSC VS TEMPERATURE

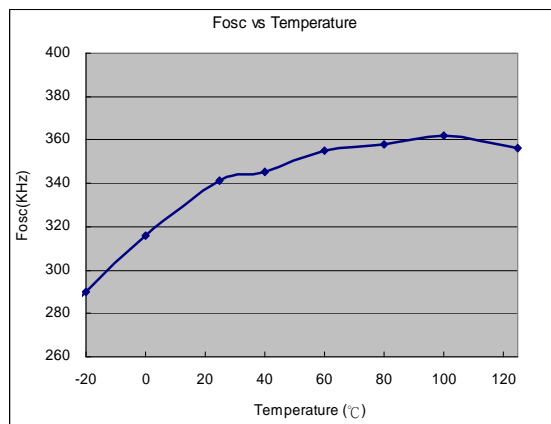

❖ TYPICAL CHARACTERISTICS (CONTINUOUS)

Efficiency ($V_{IN}=12V, V_{OUT}=5V$)

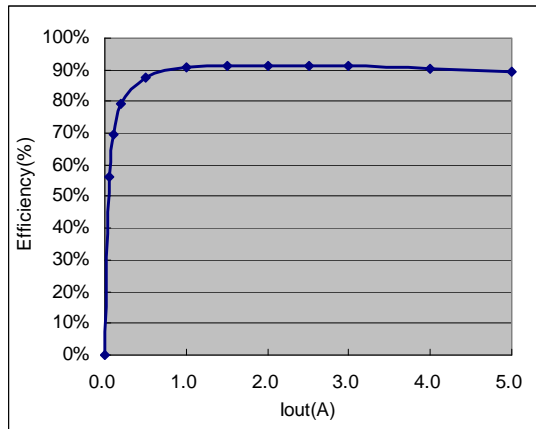

Efficiency ($V_{IN}=12V, V_{OUT}=3.3V$)

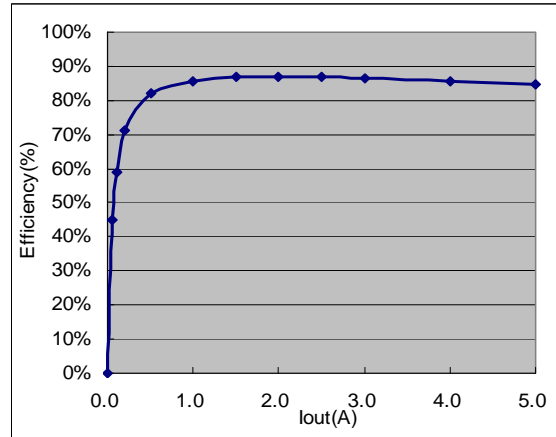

❖ TYPICAL CHARACTERISTICS (CONTINUOUS)

EN PIN on test wave
($V_{IN}=12V, V_{OUT}=5V, I_{OUT}=5A$)

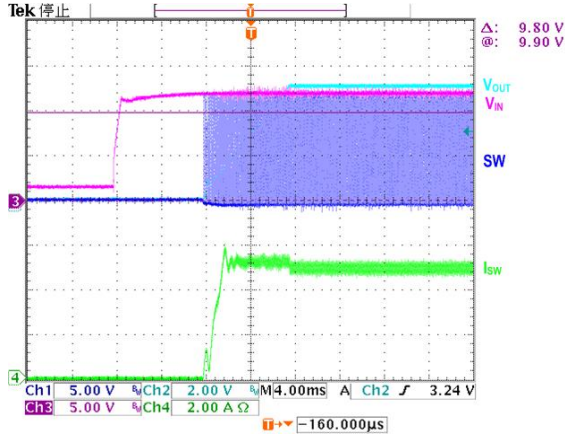

Power on test wave
($V_{IN}=12V, V_{OUT}=5V, I_{OUT}=5A$)

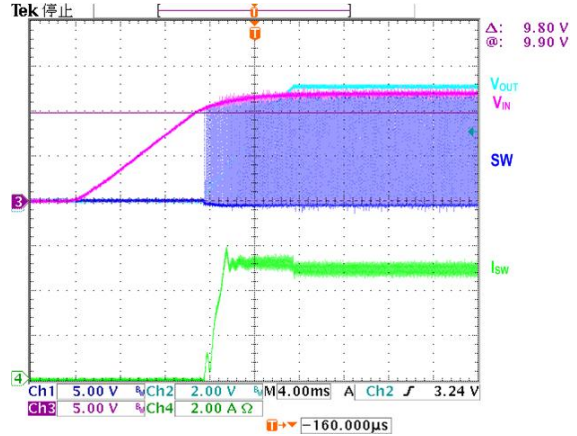

Load transient Response 0A to 5A
($V_{IN}=12V, V_{OUT}=5V$)

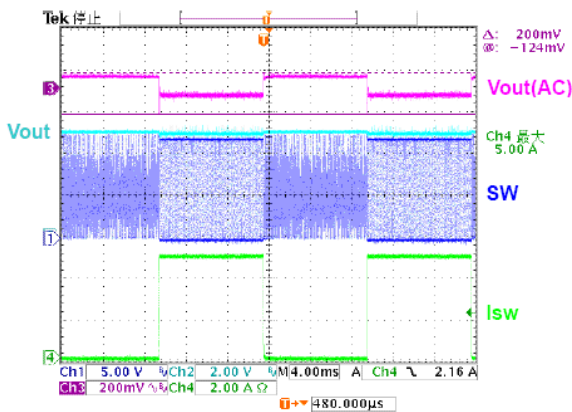

Load transient Response 0.2A to 5A
($V_{IN}=12V, V_{OUT}=5V$)

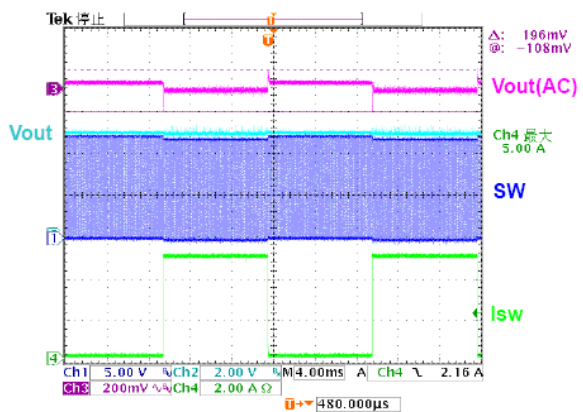

Output Ripple
($V_{IN}=12V, V_{OUT}=5V, I_{OUT}=5A$)

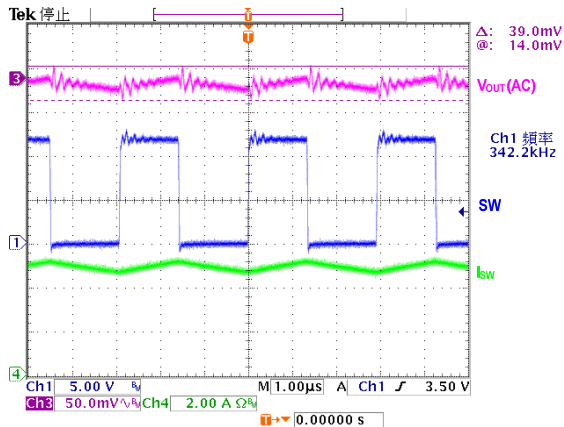

Start-Up from Thermal Shutdown
($V_{IN}=12V, V_{OUT}=5V, I_{OUT}=1A$)

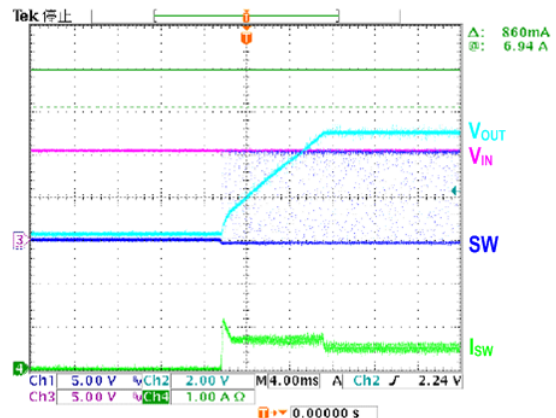

❖ PACKAGE OUTLINES

(1) SOP-8L

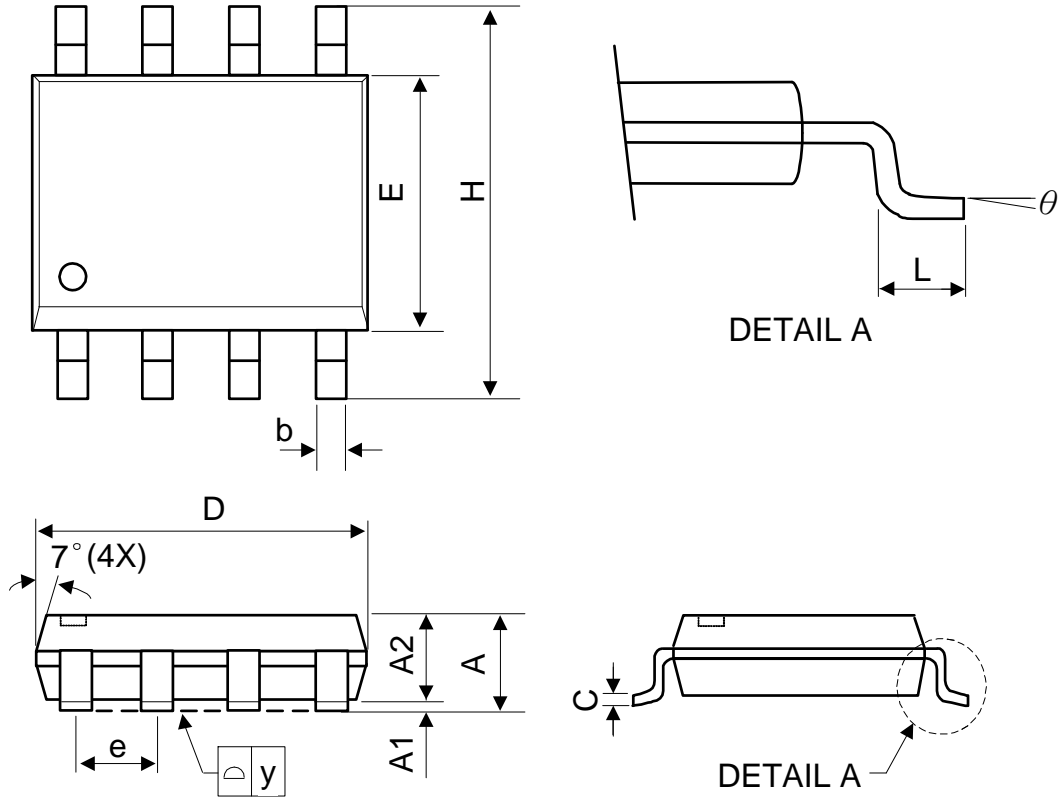

Symbol	Dimensions in Millimeters			Dimensions in Inches		
	Min.	Nom.	Max.	Min.	Nom.	Max.
A	-	-	1.75	-	-	0.069
A1	0.1	-	0.25	0.04	-	0.1
A2	1.25	-	-	0.049	-	-
C	0.1	0.2	0.25	0.0075	0.008	0.01
D	4.7	4.9	5.1	0.185	0.193	0.2
E	3.7	3.9	4.1	0.146	0.154	0.161
H	5.8	6	6.2	0.228	0.236	0.244
L	0.4	-	1.27	0.015	-	0.05
b	0.31	0.41	0.51	0.012	0.016	0.02
e	1.27 BSC			0.050 BSC		
y	-	-	0.1	-	-	0.004
theta	0°	-	8°	0°	-	8°

Mold flash shall not exceed 0.25mm per side

JEDEC outline: MS-012 AA

(2) MSOP-8L

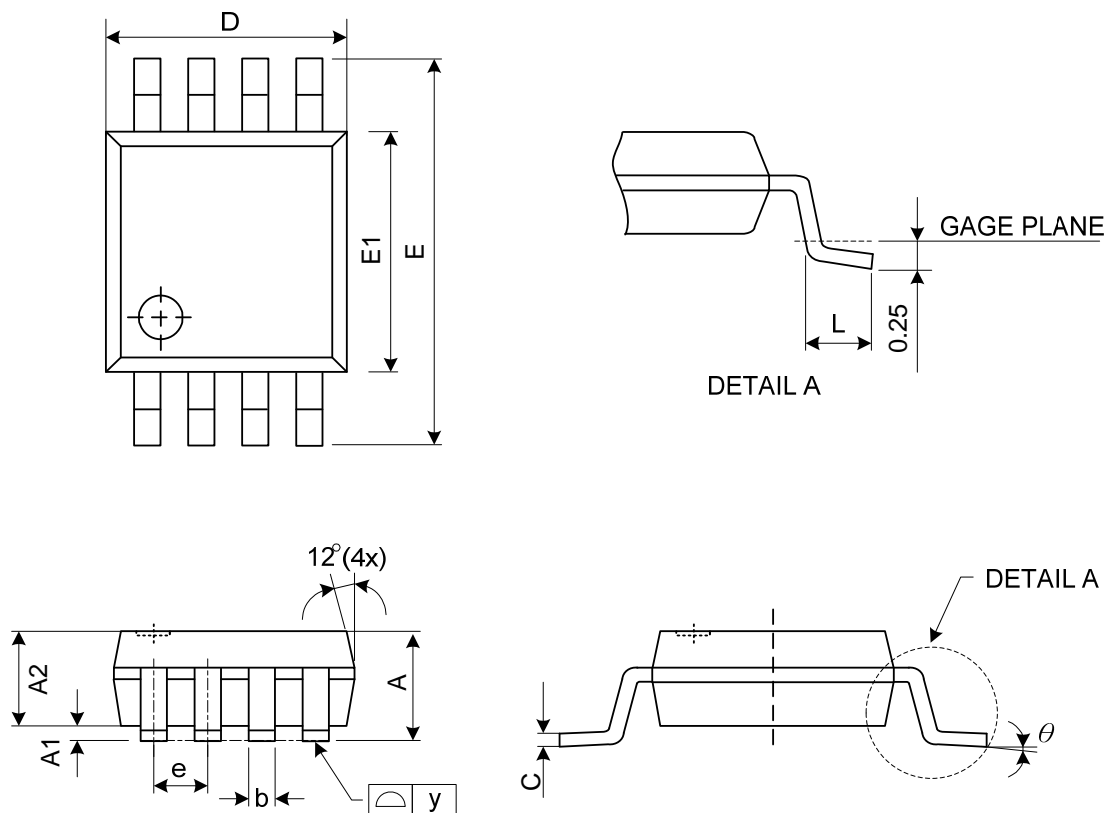

Symbol	Dimensions in Millimeters			Dimensions in Inches		
	Min.	Nom.	Max.	Min.	Nom.	Max.
A	-	-	1.10	-	-	0.043
A1	0.00	0.08	0.15	0.000	0.003	0.006
A2	0.75	0.85	0.95	0.030	0.033	0.037
b	0.22	0.30	0.38	0.009	0.012	0.015
C	0.08	0.15	0.23	0.003	0.006	0.009
D	2.90	3.00	3.10	0.114	0.118	0.122
E	4.80	4.90	5.00	0.189	0.193	0.197
E1	2.90	3.00	3.10	0.114	0.118	0.122
e	0.65 BSC			0.026 BSC		
L	0.40	0.60	0.80	0.016	0.024	0.031
y	-	-	0.1	-	-	0.004
θ	0°	4°	8°	0°	4°	8°

JEDEC outline: MO-187 AA