

## **PWM Control Controller**

### ❖ GENERAL DESCRIPTION

The AX3304/A integrates Pulse-Width-Modulation (PWM) control circuit into a single chip, mainly designs for power-supply regulator. All the functions include an error amplifier, a soft-start, UVLO, OVP, SCP, TSD circuitry.

This device features an internal 100KHz oscillator (300KHz for "A" version), the UVLO makes sure that the outputs are off until the internal circuit operates normally.

### ❖ FEATURES

- Input voltage : 8V to 40V
- Duty ratio : 0% to 100% PWM control
- Oscillation frequency : 100K/300KHz
- Thermal Shutdown function.
- Short Circuit Protect (SCP).
- External SW P-channel MOS.
- External OVP setting function.
- Current mode non-synchronous PWM converter
- External current limit setting.
- Under voltage Lockout.
- SOP-8L Pb-Free package.

❖ **BLOCK DIAGRAM**

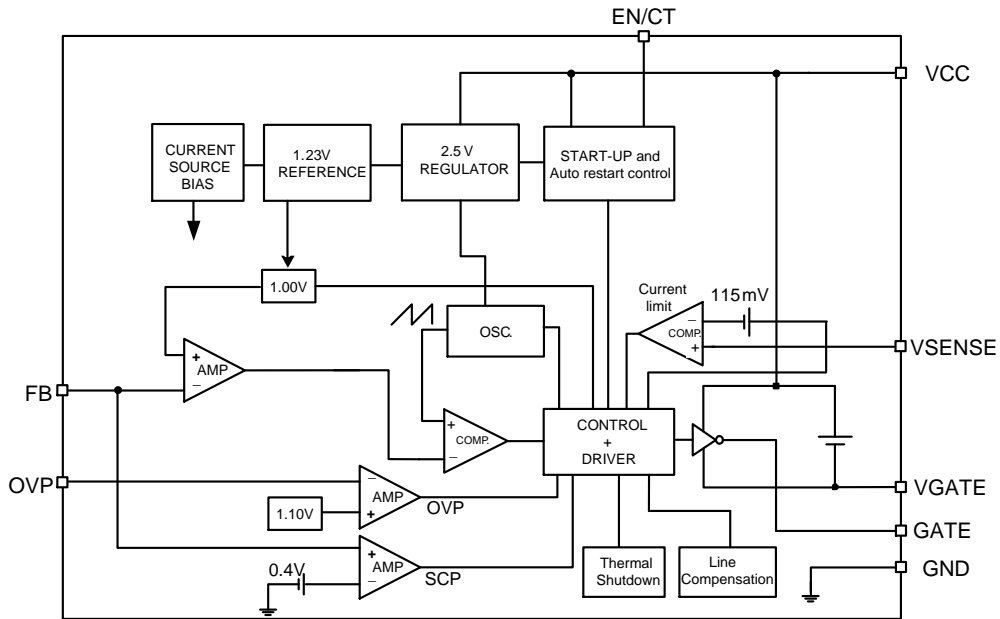

❖ **PIN ASSIGNMENT**

The package of AX3304/A is SOP-8L; the pin assignment is given by:

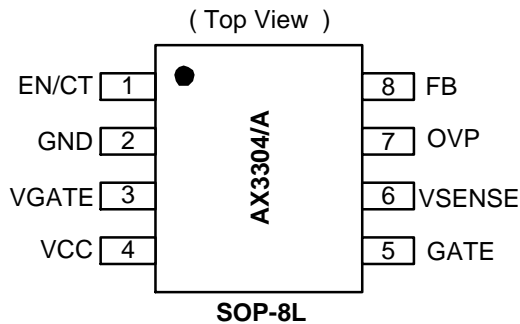

Name	Description
EN/CT	Shutdown and auto restart control pin
GND	GND pin
VGATE	Driver gate clamping pin. The pin must connect a 0.1uF capacitor to VIN
VCC	Operating voltage input
GATE	Switch pin. Connect external inductor and diode here
VSENSE	Voltage Sense input
OVP	Over voltage detect pin
FB	Feedback pin

❖ **ORDER/MARKING INFORMATION**

Order Information	Top Marking
<p><b>AX3304 X X X</b></p> <p>Frequency Blank : 100KHz A : 300KHz</p> <p>Package Type S: SOP-8L</p> <p>Packing Blank : Tube A : Taping</p>	<p>Logo ← <b>AX</b> 3 3 0 4 → Part number</p> <p>    A Y Y W W X → ID code: internal</p> <p>                    WW: 01~52</p> <p>                    Year: 11=2011                         12=2012</p> <p>Blank: AX3304</p> <p>      A: AX3304A</p>

**❖ ABSOLUTE MAXIMUM RATINGS** (at  $T_A = 25^{\circ}\text{C}$ )

Characteristics	Symbol	Rating	Unit
$V_{CC}$ Pin Voltage	$V_{CC}$	GND - 0.3 to GND + 45	V
$V_{GATE}$ , $V_{SENSE}$ Pin Voltage		GND - 0.3 to $V_{IN}$	V
Feedback, OVP, EN/CT Pin Voltage		GND - 0.3 to 6	V
Switch Pin Voltage	$V_{SW}$	GND - 0.3 to $V_{IN} + 0.3$	V
Power Dissipation	PD	$(T_J - T_A) / \theta_{JA}$	W
Storage Temperature Range	$T_{ST}$	-40 to +165	$^{\circ}\text{C}$
Operating Temperature Range	$T_{OP}$	-20 to +125	$^{\circ}\text{C}$
Operating Supply Voltage	$V_{OP}$	+8 to +40	V
Thermal Resistance from Junction to case	$\theta_{JC}$	15	$^{\circ}\text{C}/\text{W}$
Thermal Resistance from Junction to ambient	$\theta_{JA}$	40	$^{\circ}\text{C}/\text{W}$

Note :  $\theta_{JA}$  is measured with the PCB copper are (need connect to Exposed pad) of approximately  $1\text{ in}^2$ (Multi-layer).

**❖ ELECTRICAL CHARACTERISTICS** ( $V_{IN}=12\text{V}$ ,  $T_A=25^{\circ}\text{C}$ , unless otherwise specified)

Characteristics	Symbol	Conditions	Min.	Typ.	Max.	Units
Feedback Voltage	$V_{FB}$	$I_{OUT}=10\text{mA}$	0.98	1	1.02	V
Under Voltage Lockout	$U_{VLO}$	Rise	-	6	-	V
UVLO Hysteresis	-		-	1.65	-	V
OVP detect voltage	$V_{OVP}$	Internal define	1.20	1.23	1.26	V
Line Regulation	-	$V_{IN}=10 \sim 40\text{V}$ , $I_{OUT}=10\text{mA}$	-	0.2	0.5	%
Load Regulation	-	$I_{OUT}=0\sim 3\text{A}$ , $R_{SENSE} = 33\text{m}\Omega$ AX3304/A	-	0.5	1	%
Quiescent Current	$I_{CCQ}$	$V_{FB} = 1.5\text{V}$ , force driver off.	-	4	8	mA
Oscillator frequency	$F_{OSC}$	$I_{OUT} = 0.5\text{A}$ AX3304	70	100	130	KHz
		AX3304A	240	300	360	KHz
Max. Duty Cycle (ON)	DC	Force driver on $V_{FB} = 0.6\text{V}$	-	100	-	%
Min. Duty Cycle (OFF)		Force driver off $V_{FB} = 1.5\text{V}$	-	0	-	%
Sense Voltage	$V_{CC}-V_{SENSE}$		-	115	-	mV
EN/CT pin logic input threshold voltage	$V_{EN1}$	Shutdown mode	-	-	0.4	V
	$V_{CT}$	Auto restart, $V_{FB}<0.4\text{V}$	0.5	-	1.5	V
EN/CT pin current	$I_{EN/CT-C}$	Charge current	-	-30	-	$\mu\text{A}$
EN/CT pin current	$I_{EN/CT-D}$	Discharge current	-	1.3	-	$\mu\text{A}$
Thermal shutdown Temp	$T_{SD}$		-	160	-	$^{\circ}\text{C}$
Thermal Shutdown Hysteresis	$T_{SH}$		-	50	-	$^{\circ}\text{C}$

❖ **APPLICATION CIRCUIT**

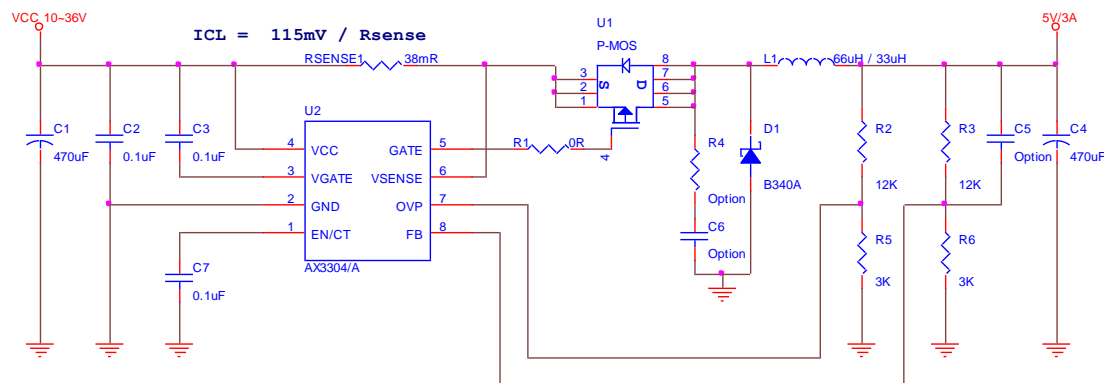

❖ **FUNCTION DESCRIPTIONS**

**FB**

Sense the regulated output voltage to complete the feedback loop, when  $V_{FB} < 0.4V$ , the SCP is happened.

**$V_{SENSE}$**

The current limit sense pin, if  $V_{IN} - V_{SENSE} \geq 115mV$ , the over current is happened that it can turn-off driver cycle by cycle.

**OVP**

The Over Voltage sense pin, If  $V_{OVP} > 1.23V$ , the OVP is happened that it can turn-off the driver. You can set  $V_{OUT}$  OVP voltage by outside resistances (R3 and R4), Please see below formula to set.

$$V_{OUT(OVP)} = 1.23 \times \left(1 + \frac{R2}{R5}\right)$$

The Over Voltage Protect, If  $V_{OVP} > 1.23V$ , the OVP is happened that it can turn-off the driver.

**Under Voltage Lockout (UVLO)**

To avoid error-operation of the device at low input voltages an under voltage lockout is included that disables the device, if the input voltage falls below 6.0V.

**Thermal Considerations**

The SOP-8L package needs a heat sink under most conditions. The heat sink connect exposed pad of AX3304/A to obtain best effect. The size of the heat sink depends on the input voltage, output voltage, output current and ambient temperature.

❖ **APPLICATION INFORMATION**

**Setting the Output Voltage**

Application circuit item shows the basic application circuit with adjustable output version. The external resistor sets the output voltage according to the following equation:

$$V_{OUT} = 1.0V \times \left(1 + \frac{R3}{R6}\right)$$

Table 1 Resistor select for output voltage setting

V <sub>OUT</sub>	R6	R3
5.0V	3K	12K
3.3V	3K6	8K2

**Current Limit Protection**

The Current limit is set by external resistor (R<sub>SENSE</sub>), When the V<sub>SENSE</sub> pin voltage small than VCC 115mV, the current limit is happened that driver can be turned off. Refer to the following equation for set up current limit:

$$\text{Current Limit (A)} = \frac{115\text{mV}}{R_{SENSE}}$$

The maximum output current table is shown as below; please refer the table to design.

RSENSE (Ω)	Current Limit (A)	Maximum Output Current (A)
29m	3.96	3.7
38m	3.03	3.0
54m	2.13	1.9

### Inductor Selection

For most designs, the different frequency can be reducing the inductor value; The AX3304/A is suggested 22μH to 100μH for 100K to 300KHz frequencies. Please refer the below table to design.

L1 recommend value (V <sub>IN</sub> =10~30V ,V <sub>OUT</sub> =5V, I <sub>OUT</sub> =2A)		
Version	AX3304	AX3304A
L1 Value (H)	68~100u	22~47u

Where is inductor Ripple Current. Large value inductors lower ripple current and small value inductors result in high ripple currents. Choose inductor ripple current approximately 20% of the maximum load current 3A, Δ<sub>L</sub>=0.6A. The DC current rating of the inductor should be at least equal to the maximum load current plus half the ripple current to prevent core saturation (3A+0.3A).

### Input Capacitor Selection

This capacitor should be located close to the IC using short leads and the voltage rating should be approximately 1.5 times the maximum input voltage. The RMS current rating requirement for the input capacitor of a buck regulator is approximately 1/2 the DC load current. A low ESR input capacitor sized for maximum RMS current must be used. A 220~470μF low ESR capacitor for most applications is sufficient.

### Output Capacitor Selection

The output capacitor is required to filter the output and provide regulator loop stability. The important capacitor parameters are; the 100 KHz Equivalent Series Resistance (ESR), the RMS ripples current rating, voltage rating, and capacitance value. For the output capacitor, the ESR value is the most important parameter. The ESR can be calculated from the following formula.

$$V_{RIPPLE} = \Delta I_L \times ESR = 0.6A \times 80m\Omega = 48mV$$

An aluminum electrolytic capacitor's ESR value is related to the capacitance and its voltage rating. In most case, higher voltage electrolytic capacitors have lower ESR values. Most of the time, capacitors with much higher voltage ratings may be needed to provide the low ESR values required for low output ripple voltage. System stability is depending on output capacitor's ESR, Correct to choose output capacitor's ESR is very important. It is recommended to using a 220~470 $\mu$ F, the ESR values range is 40~130m $\Omega$ .

### EN/CT

The pin is enable/shutdown and auto restart control functions. When system is normal operating, this pin is enable/shutdown function. Pulling this pin below a threshold voltage of under 0.3V shuts the regulator off, and pulling this pin from 0.5V to 1.5V turns the regulator on. However when  $V_{OUT}$  is short ( $V_{FB} < 0.4V$ ), the auto restart function can be started that restart the regulator cycle by cycle. The cycle time is set by outside capacitor (C6). Please refer the below waveform and formula, the t2 cycle is regulator off time and t1 cycle is current limit time. The charge-current is 30 $\mu$ A and discharge-current is 1.3 $\mu$ A.

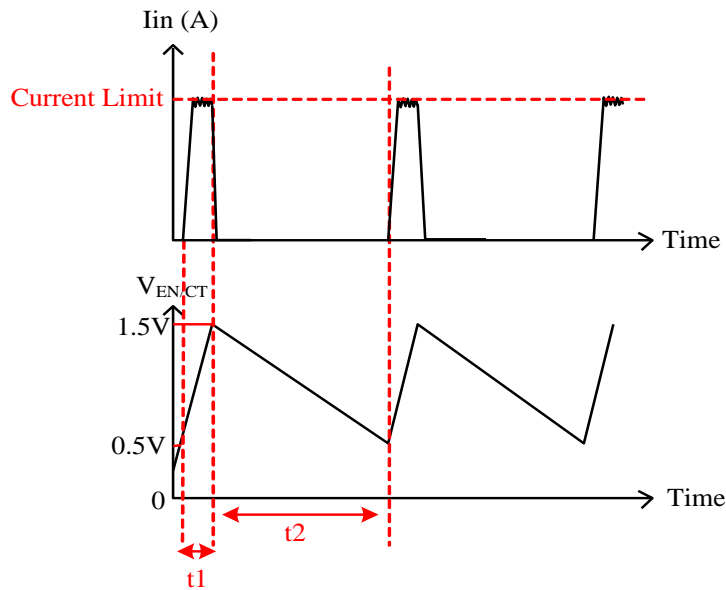

### Thermal Considerations

The SOP-8L package needs a heat sink under most conditions. The heat sink connect exposed pad of AX3304/A to obtain best effect. The size of the heat sink depends on the input voltage, the output voltage, the load current and the ambient temperature.

❖ TYPICAL CHARACTERISTICS

Power OFF/ON

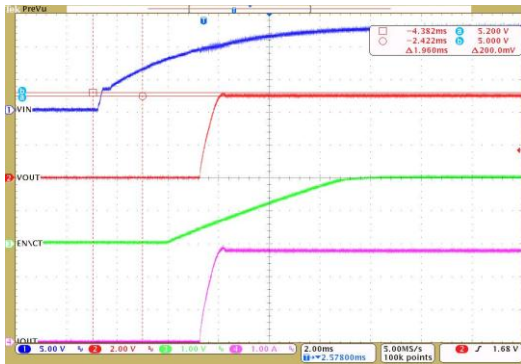

$V_{IN}=12V, V_{OUT}=5V, I_{OUT}=3A$

Power OFF/ON



$V_{IN}=32V, V_{OUT}=5V, I_{OUT}=3A$

Load Transient

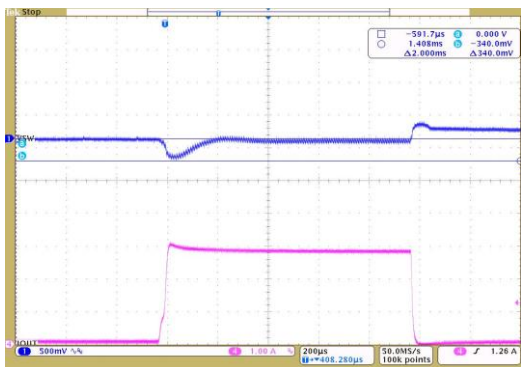

$V_{IN}=12V, V_{OUT}=5V, I_{OUT}=3\sim 0A (100kHz)$

Load Transient

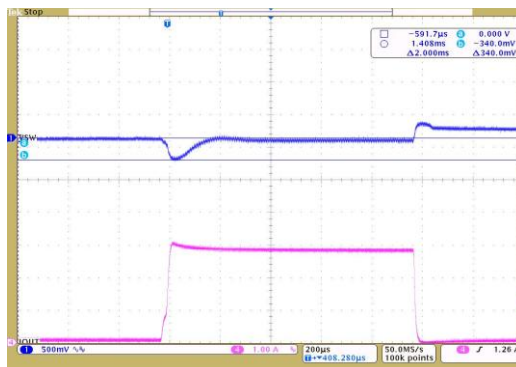

$V_{IN}=32V, V_{OUT}=5V, I_{OUT}=3\sim 0A (100kHz)$

Load Transient

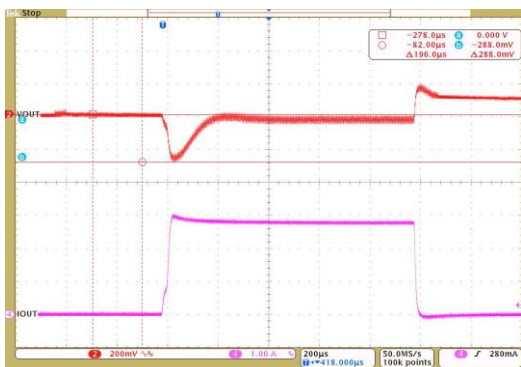

$V_{IN}=12V, V_{OUT}=5V, I_{OUT}=3\sim 0A (300kHz)$

Load Transient

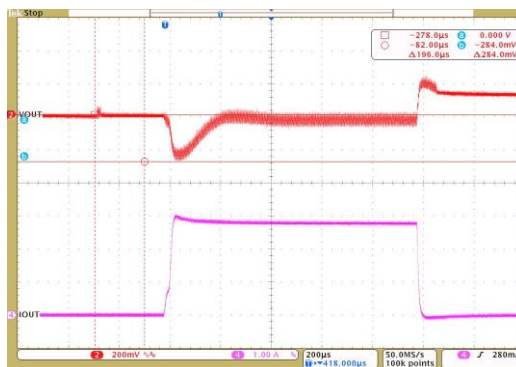

$V_{IN}=32V, V_{OUT}=5V, I_{OUT}=3\sim 0A (300kHz)$



❖ TYPICAL CHARACTERISTICS (CONTINUOUS)

Short → Release

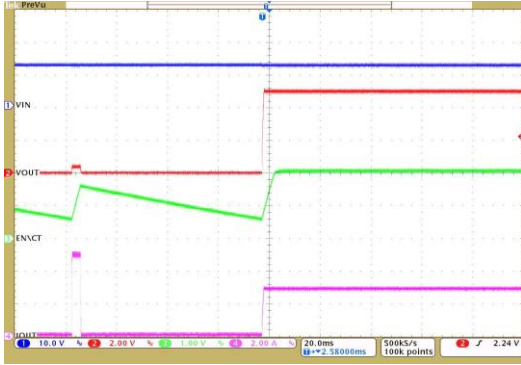

$V_{IN}=12V, V_{OUT}=5V, I_{OUT}=3A$

Short → Release

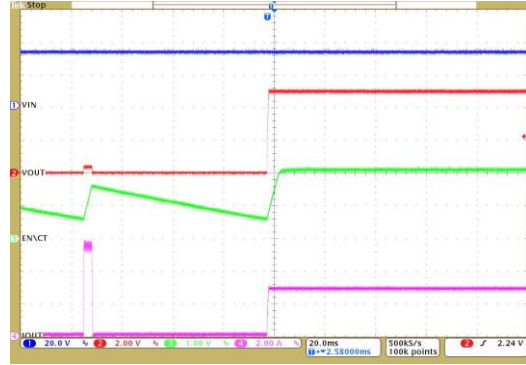

$V_{IN}=32V, V_{OUT}=5V, I_{OUT}=3A$

EN Off → ON

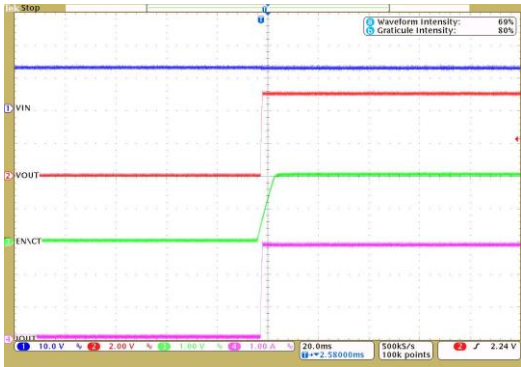

$V_{IN}=12V, V_{OUT}=5V, I_{OUT}=3A$

EN Off → ON



$V_{IN}=32V, V_{OUT}=5V, I_{OUT}=3A$

❖ TYPICAL CHARACTERISTICS (CONTINUOUS)

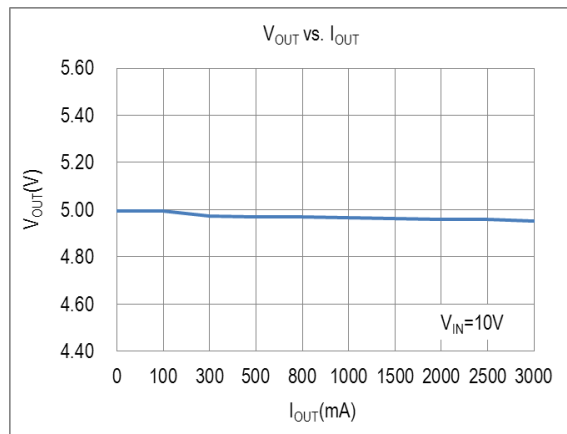
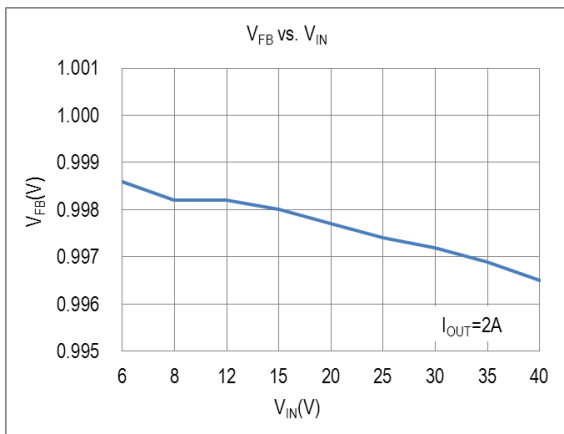
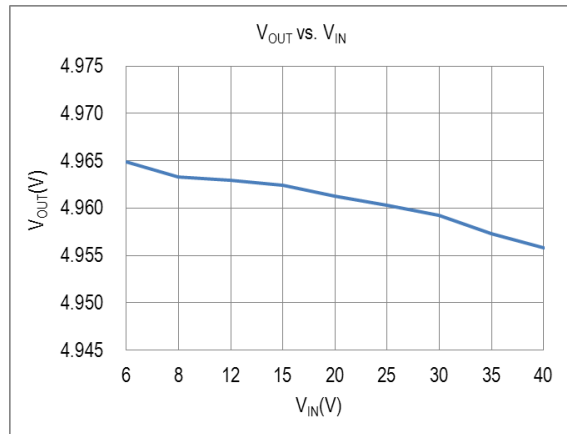
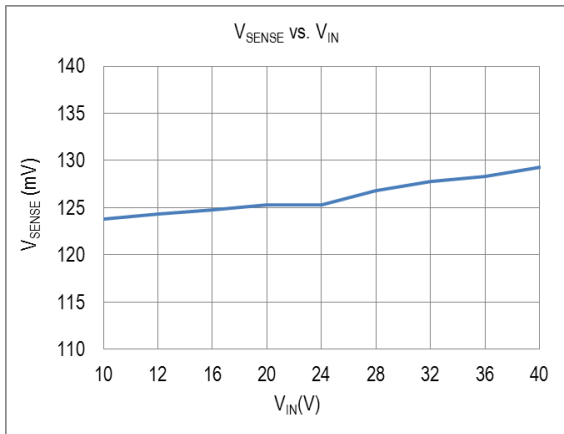
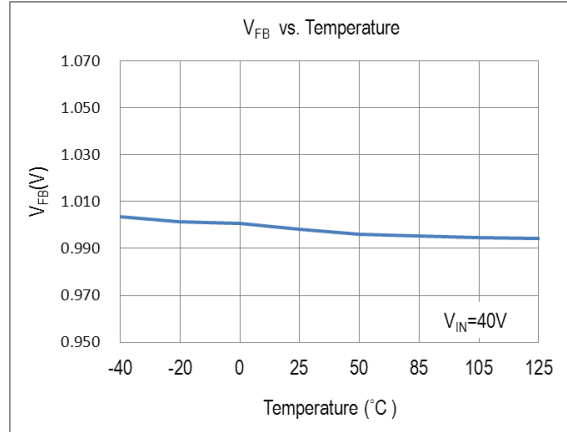
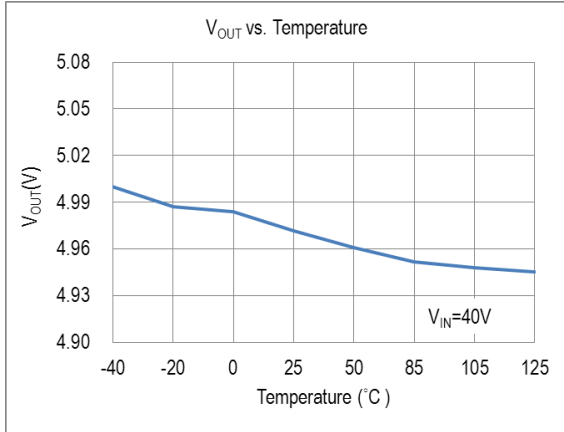

❖ **TYPICAL CHARACTERISTICS (CONTINUOUS)**

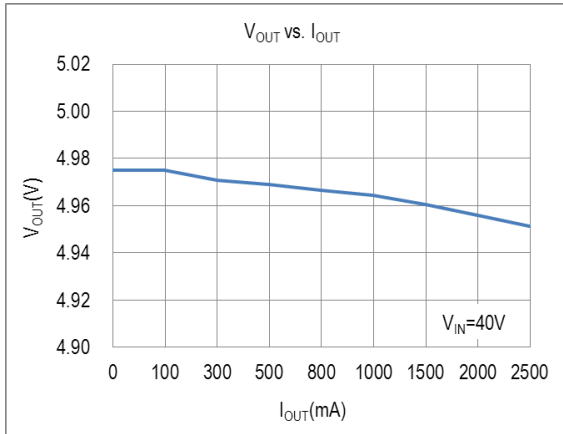
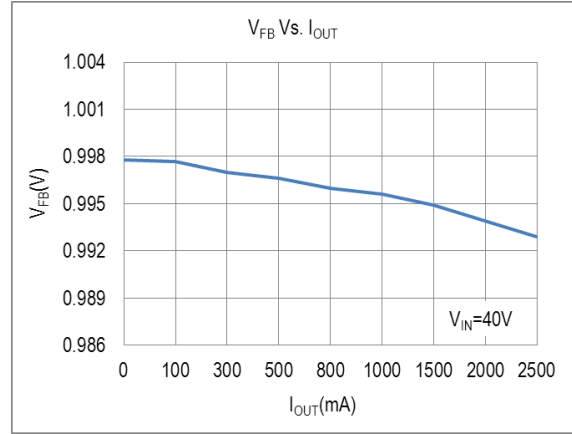
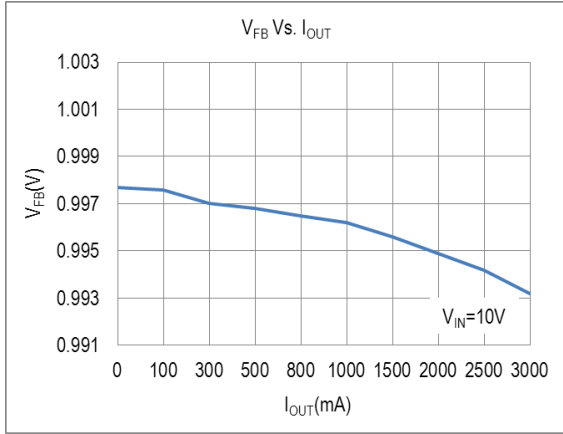

❖ PACKAGE OUTLINES

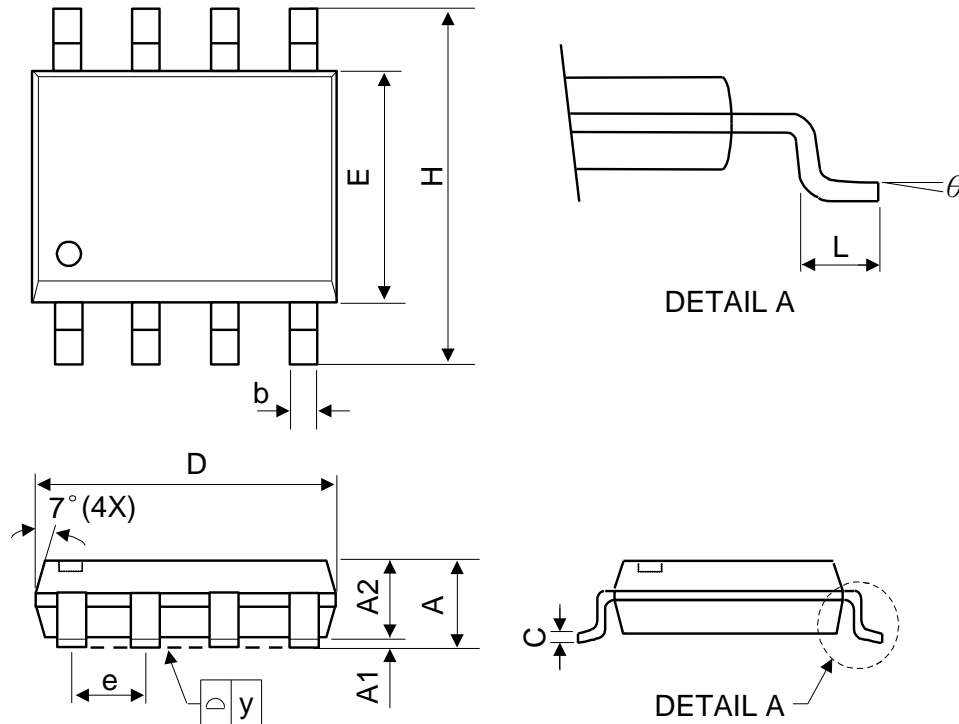

Symbol	Dimensions in Millimeters			Dimensions in Inches		
	Min.	Nom.	Max.	Min.	Nom.	Max.
A	-	-	1.75	-	-	0.069
A1	0.1	-	0.25	0.04	-	0.1
A2	1.25	-	-	0.049	-	-
C	0.1	0.2	0.25	0.0075	0.008	0.01
D	4.7	4.9	5.1	0.185	0.193	0.2
E	3.7	3.9	4.1	0.146	0.154	0.161
H	5.8	6	6.2	0.228	0.236	0.244
L	0.4	-	1.27	0.015	-	0.05
b	0.31	0.41	0.51	0.012	0.016	0.02
e	1.27 BSC			0.050 BSC		
y	-	-	0.1	-	-	0.004
θ	0°	-	8°	0°	-	8°

Mold flash shall not exceed 0.25mm per side

JEDEC outline: MS-012 AA