

Dual 600mA LDO Regulator with Enable Function

❖ GENERAL DESCRIPTION

The AX6636A/B/C is an efficient, precise dual-channel CMOS LDO regulator optimized for ultra-low-quiescent applications. Regulators output1 and output2 are capable of sourcing 600mA of output current. The regulators are stable with output capacitors as low as 1 μ F, including current limit, thermal shutdown protection, fast transient response, low dropout voltage, high output accuracy, current limiting protection, and high ripple rejection ratio. The AX6636A/B/C contains internal pull high enable function that allows the output of each regulator to be turned off independently. The AX6636A/B/C regulators are available in used SOP-8L with Exposed Pad package.

❖ FEATURES

- Input voltage range :
 - Channel1: 3.4V to 5.5V
 - Channel2: 2.8V to 5.5V
- Low Quiescent Current is 50uA/per channel (typ.)
- Fast transient response
- Tight Load and Line Regulation
- Current limit and thermal shutdown protection
- Support Ceramic Capacitors and Aluminum Electrolytic Capacitors for Stability
- Available in the SOP-8L with exposed pad Pb-Free Package

❖ BLOCK DIAGRAM

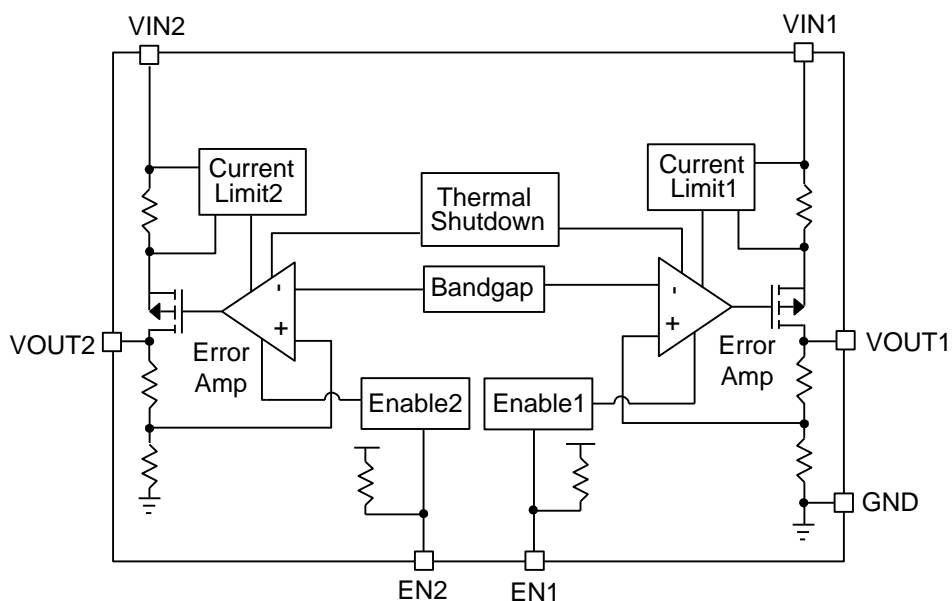

❖ ELECTRICAL CHARACTERISTICS

($V_{IN1} = V_{IN2} = 5V$, $T_A = 25^\circ C$ (unless otherwise noted))

Characteristics	Symbol	Conditions	Min	Typ	Max	Units	
Input Voltage (Note 1)	V_{IN1}	$I_{OUT1} = 30mA$	3.4	-	5.5	V	
	V_{IN2}	$I_{OUT2} = 30mA$	2.8	-	5.5	V	
Enable Input Threshold	$V_{EN1/2H}$	Each channel	2.0	-	-	V	
	$V_{EN1/2L}$		-	-	0.8		
Shutdown Current	$I_{SD(1+2)}$	$I_{OUT1,2} = 0mA$, $V_{IN1,2} = 5V$, $V_{EN1,2} = 0V$	-	4	8	μA	
Temperature Shutdown	$T_{SD1,2}$		-	150	-	$^\circ C$	
Temperature Shutdown Hysteresis	$T_{SDR1,2}$		-	40	-	$^\circ C$	
Regulator1							
Output Voltage Accuracy	V_{OUT1}	$I_{OUT1} = 30mA$	3.234	3.3	3.366	V	
Output Voltage Temperature stability		$I_{OUT1} = 10mA$ (Note 4)	-	1	-	%	
Dropout Voltage	V_{DROP1}	$I_{OUT1} = 600mA$, $V_{OUT1} = V_{OUT1} - 2\%$	-	300	500	mV	
Quiescent Current	I_{Q1}	$I_{OUT1} = 0mA$, $V_{IN1} = 5V$	-	50	80	μA	
Line Regulation	V_{Line1}	$V_{IN1} = 4V$ to $5.5V$, $I_{OUT1} = 30mA$	-	0.1	0.2	%/V	
Load Regulation	ΔV_{LOAD}	$I_{OUT1} = 1m \sim 600mA$	-	10	40	mV	
Current Limit	I_{LIMIT1}	$V_{IN1} = 5.0V$	700	-	-	mA	
Short Circuit Current	I_{short1}	$V_{OUT1} < 0.25 * V_{OUT1}$	-	500	-	mA	
Ripple Rejection	PSRR1	$I_{OUT1} = 30mA$, $F = 100Hz$	-	-60	-	dB	
Regulator2							
Output Voltage Accuracy	V_{OUT2}	$I_{OUT2} = 30mA$ (AX6636A)	1.764	1.8	1.836	V	
		$I_{OUT2} = 30mA$ (AX6636B)	1.470	1.5	1.530		
		$I_{OUT2} = 30mA$ (AX6636C)	1.176	1.2	1.224		
Output Voltage Temperature Stability		$I_{OUT2} = 10mA$	-	1	-	%	
Dropout Voltage	V_{DROP2}	$I_{OUT2} = 600mA$, $V_{OUT2} = V_{OUT2} - 2\%$	$V_{OUT2} = 1.8V$	-	700	1000	mV
			$V_{OUT2} = 1.5V$	-	1000	1300	
			$V_{OUT2} = 1.2V$	-	1300	1600	
Quiescent Current	I_{Q1}	$I_{OUT2} = 0mA$, $V_{IN2} = 5V$	-	50	80	μA	
Line Regulation	V_{Line1}	$V_{IN2} = 3.0V$ to $5.5V$, $I_{OUT2} = 30mA$	-	0.1	0.2	%/V	
Load Regulation (Note 3)	ΔV_{LOAD}	$I_{OUT2} = 1m \sim 600mA$	-	10	30	mV	
Current Limit (Note 2)	I_{LIMIT2}	$V_{IN2} = 5.0V$	700	-	-	mA	
Short Circuit Current	I_{short2}	$V_{OUT2} < 0.25 * V_{OUT2}$	-	500	-	mA	
Ripple Rejection	PSRR2	$I_{OUT2} = 30mA$, $F = 100Hz$	-	-60	-	dB	

Note1: The device is not guaranteed to function outside its operating conditions.

Note2: Current limit is measured at constant junction temperature by using pulsed testing with a low ON time.

Note3: Regulation is measured at constant junction temperature by using pulsed testing with a low ON time.

Note 4: Guaranteed by design.

❖ APPLICATION CIRCUIT

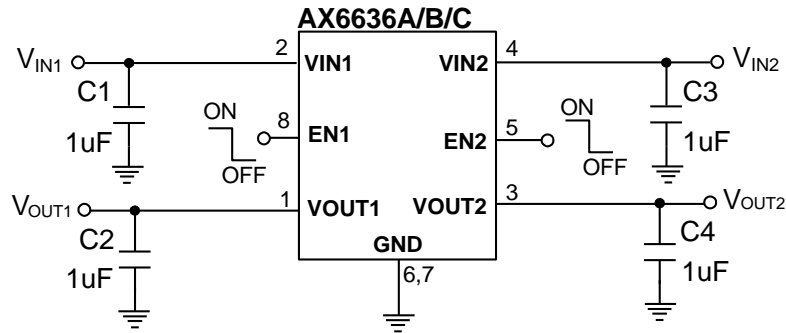

❖ FUNCTION DESCRIPTIONS

The AX6636A/B/C is a highly accurate, dual, low noise, CMOS LDO voltage regulators with enable function. The output voltage for each regulator is set independently by fuse trimming. As illustrated in function block diagram, it consists of a reference, error amplifier, a P-channel pass transistor, an ON/OFF control logic and an internal feedback voltage divider. The band gap reference is connected to the error amplifier, which compares the reference with the feedback voltage and amplifies the voltage difference. If the feedback voltage is lower than the reference voltage, the pass-transistor gate is pulled lower, which allows more current to pass to the VOUT pin and increases the output voltage. If the feedback voltage is too high, the pass transistor gate is pulled up to decrease the output voltage. The output voltage is feed back through an internal resistive divider connected to VOUT pin. Additional blocks include an output current limiter, thermal sensor, and shutdown logic.

Enable Function

EN1 and EN2 pin start and stop the corresponding outputs independently. Those pins are internal pull high. When the EN pin is switched to the power off level, the operation of all internal circuit stops, the build-in P-channel MOSFET output transistor between pins VIN and VOUT is switched off, allowing current consumption to be drastically reduced.

Dropout Voltage

A regulator's minimum input-output voltage differential, or dropout voltage, determines the lowest usable supply voltage. The AX6636A/B/C use a P-channel MOSFET pass transistor, its dropout voltage is function of drain-to-source on-resistance $R_{DS(ON)}$ multiplied by the load current.

$$V_{DROPOUT} = V_{IN} - V_{OUT} = R_{DS(ON)} * I_{OUT}$$

Current Limit

Each channel of AX6636A/B/C includes a fold back current limiter. It monitors and controls the pass transistor's gate voltage, estimates the output current, and limits the output current minimum 700mA.

Thermal Shutdown Protection

Thermal Shutdown protection limits total power dissipation of AX6636A/B/C. When the junction temperature exceeds $T_J = +150^{\circ}\text{C}$, a thermal sensor turns off the pass transistor, allowing the IC to cool down. The thermal sensor turns the pass transistor on again after the junction temperature cools down by 25°C , resulting in a pulsed output during continuous thermal shutdown conditions.

Thermal shutdown protection is designed to protect the AX6636A/B/C in the event of fault conditions. For continuous operation, the absolute maximum operating junction temperature rating of $T_J = +125^{\circ}\text{C}$ should not be exceeded.

❖ APPLICATION INFORMATION

Like any low-dropout regulator, the AX6636A/B/C requires input and output decoupling capacitors. The device is specifically designed for portable applications requiring minimum board space and smallest components. These capacitors must be correctly selected for good performance (see Capacitor Characteristics Section). Please note that linear regulators with a low dropout voltage have high internal loop gains which require care in guarding against oscillation caused by insufficient decoupling capacitance.

Input Capacitor

An input capacitance of $1\mu\text{F}$ is required between input pin and ground directly (the amount of the capacitance may be increased without limit). The input capacitor must be located less than 1cm from the device to assure input stability. A lower ESR capacitor allows the use of less capacitance, while higher ESR type (like aluminum electrolytic) requires more capacitance. Capacitor types (aluminum, ceramic and tantalum) can be mixed in parallel, but the total equivalent input capacitance/ ESR must be defined as above to stable operation. There are no requirements for the ESR on the input capacitor, but tolerance and temperature coefficient must be considered when selecting the capacitor to ensure the capacitance will be $1\mu\text{F}$ over the entire operating temperature range.

Output Capacitor

The AX6636A/B/C is designed specifically to support very small ceramic and aluminum electrolytic output capacitors. A ceramic capacitor (temperature characteristics X7R, X5R) in 1 μ F is suitable for the AX6636A/B/C application. The recommended minimum capacitance for the device is 1 μ F, X5R or X7R dielectric ceramic, between VOUT and GND for stability, but it may be increased without limit. An aluminum electrolytic capacitor from 4.7 μ F to 470 μ F is suitable for AX6636A/B/C application. Higher capacitance values help to improve transient. The output capacitor's ESR is critical because it forms a zero to provide phase lead which is required for loop stability.

Thermal Considerations

The AX6636A/B/C series can deliver a current of up to 600mA/channel over the full operating junction temperature range. However, the maximum output current must be debated at higher ambient temperature to ensure the junction temperature does not exceed 125°C. With all possible conditions, the junction temperature must be within the range specified under operating conditions. Power dissipation can be calculated based on the output current and the voltage drop across regulator.

$$P_D = (V_{IN} - V_{OUT}) I_{OUT} + V_{IN} I_{GND}$$

The final operating junction temperature for any set of conditions can be estimated by the following thermal equation:

$$P_{D(MAX)} = (T_{J(MAX)} - T_A) / \theta_{JA}$$

Where $T_{J(MAX)}$ is the maximum junction temperature of the die (125°C) and T_A is the maximum ambient temperature. The junction to ambient thermal resistance (θ_{JA}) SOP-8L-EP package at recommended minimum footprint is 45°C/W that is connect 1 in² PCB copper area to exposed pad.

❖ TYPICAL CHARACTERISTICS

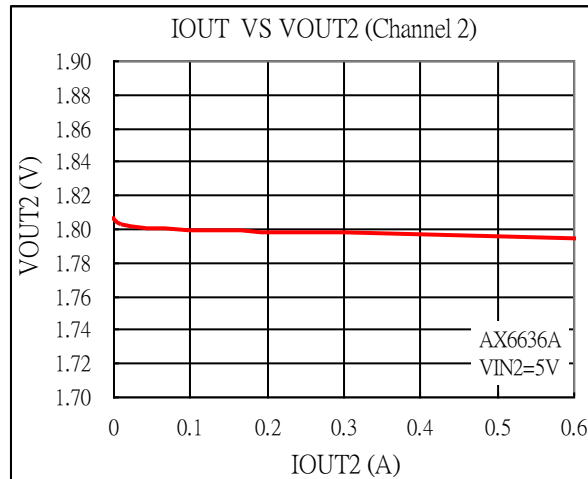
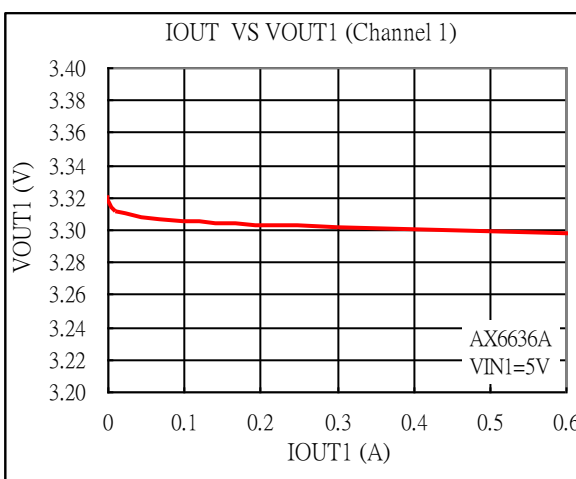
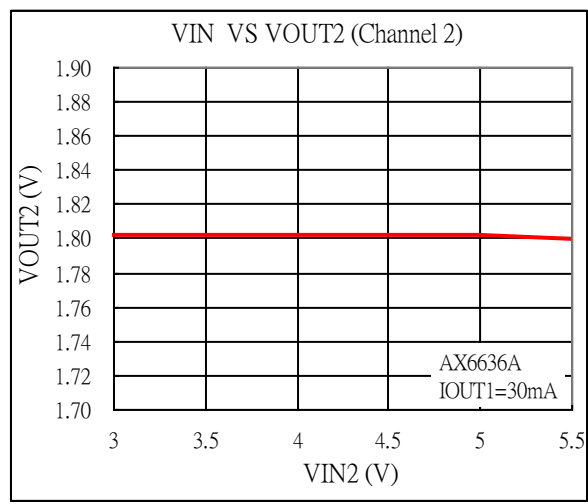
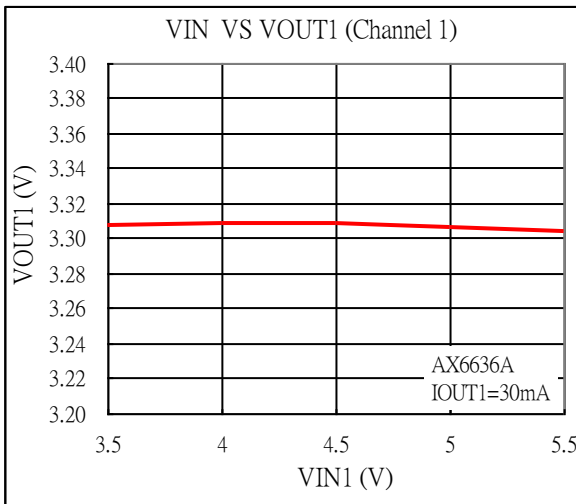
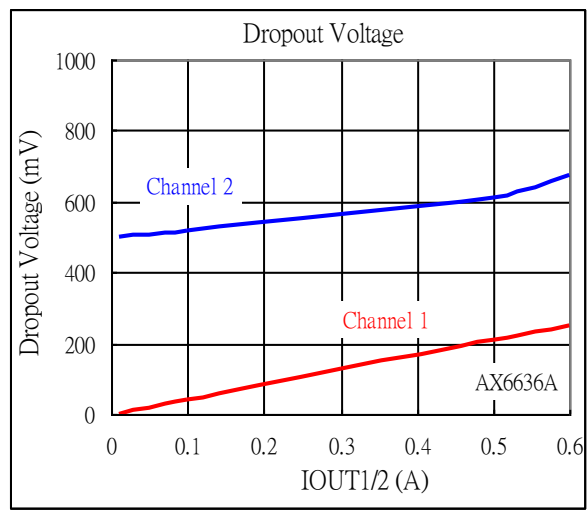
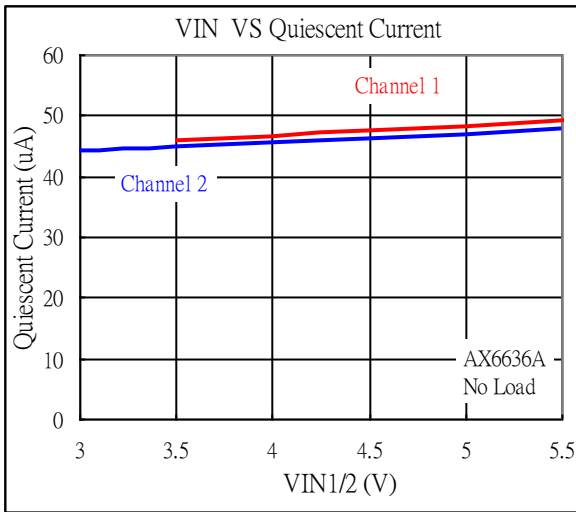

❖ TYPICAL CHARACTERISTICS (CONTINUOUS)

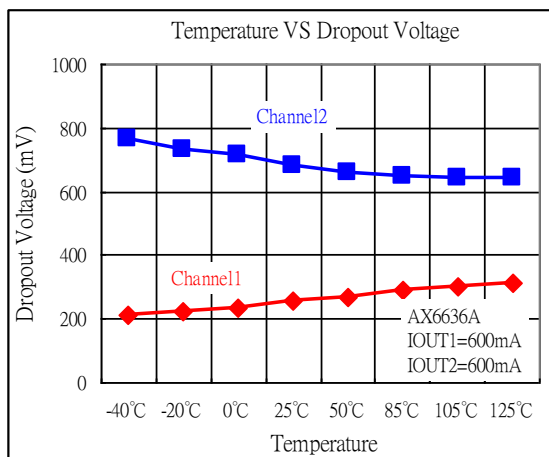
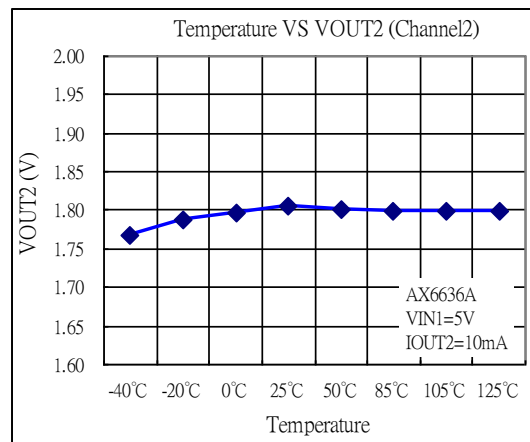
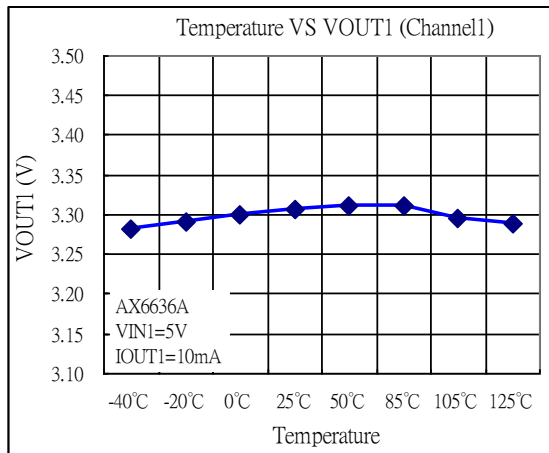

❖ TYPICAL CHARACTERISTICS (CONTINUOUS)

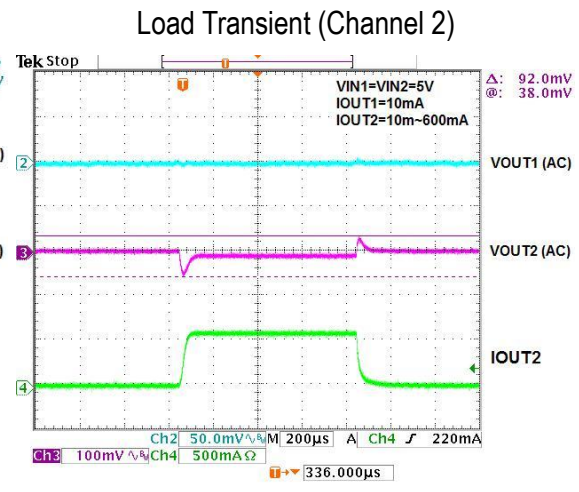
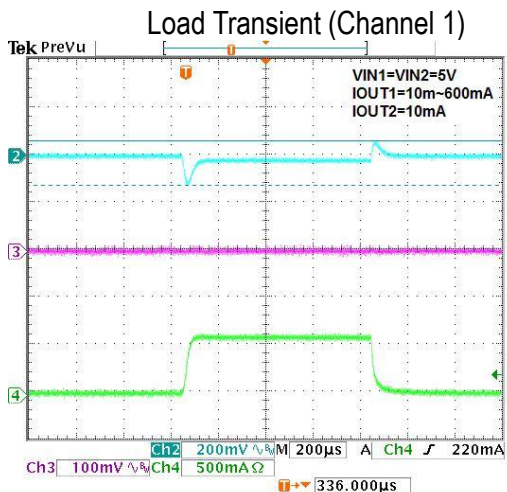
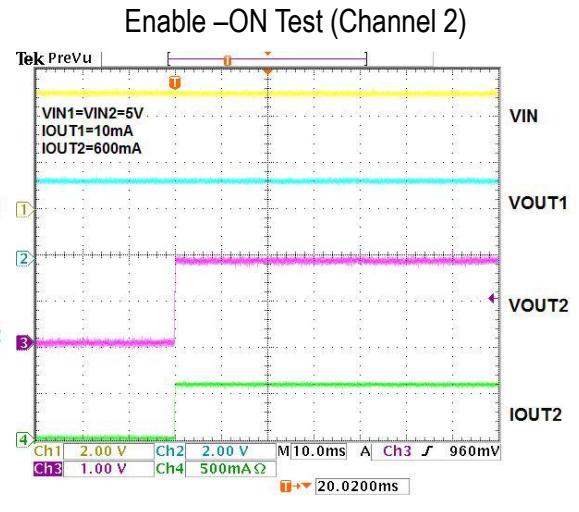
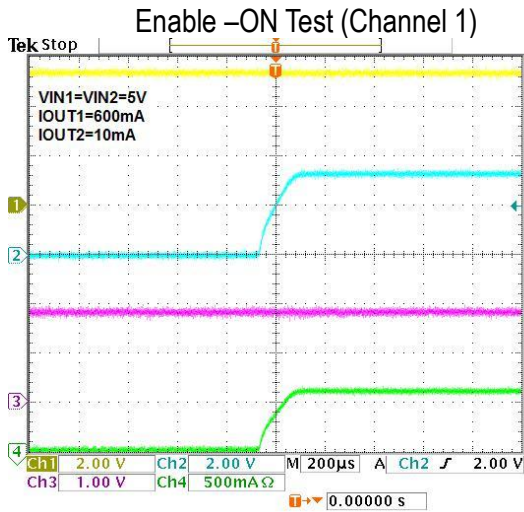
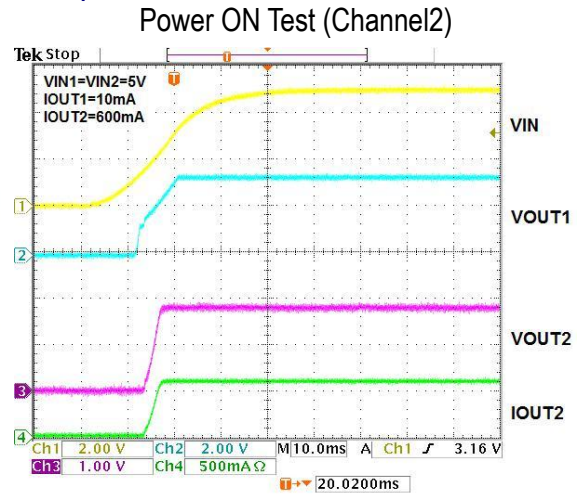
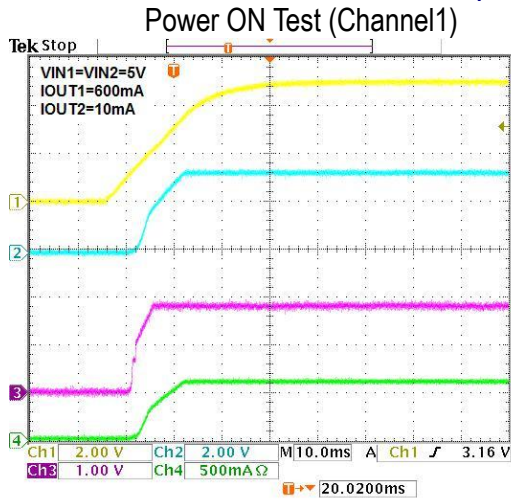

❖ PACKAGE OUTLINES

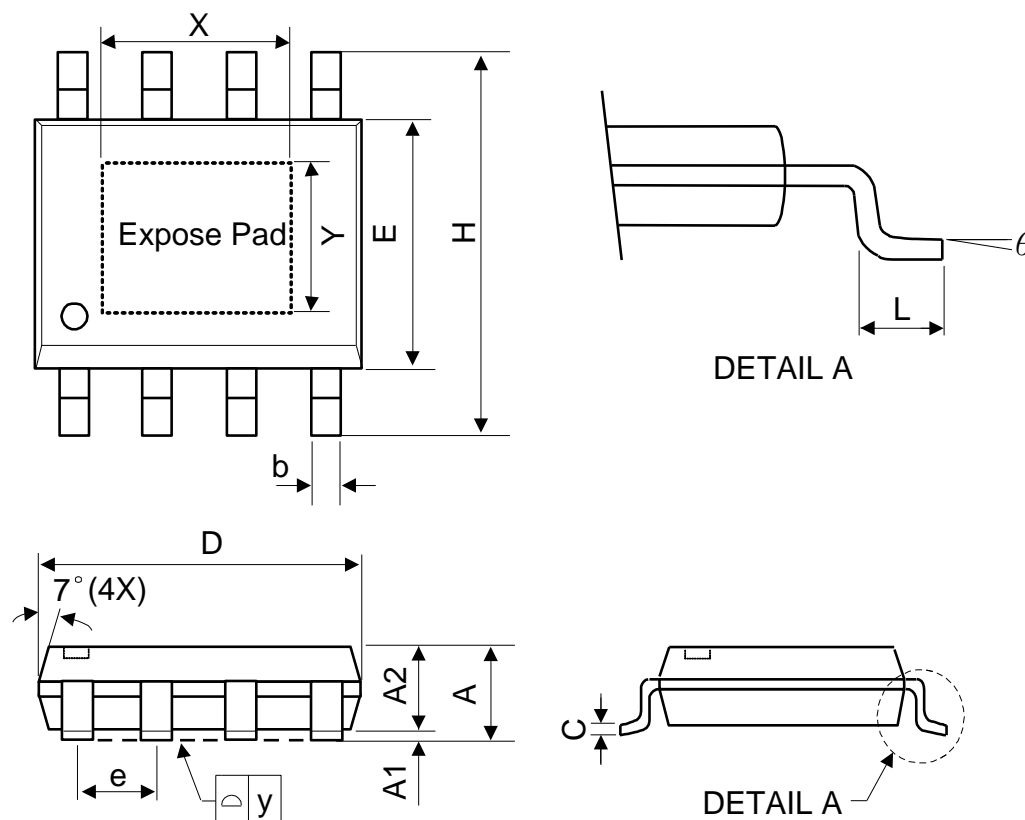

Symbol	Dimensions in Millimeters			Dimensions in Inches		
	Min.	Nom.	Max.	Min.	Nom.	Max.
A	-	-	1.75	-	-	0.069
A1	0	-	0.15	0	-	0.06
A2	1.25	-	-	0.049	-	-
C	0.1	0.2	0.25	0.0075	0.008	0.01
D	4.7	4.9	5.1	0.185	0.193	0.2
E	3.7	3.9	4.1	0.146	0.154	0.161
H	5.8	6	6.2	0.228	0.236	0.244
L	0.4	-	1.27	0.015	-	0.05
b	0.31	0.41	0.51	0.012	0.016	0.02
e	1.27 BSC			0.050 BSC		
y	-	-	0.1	-	-	0.004
X	-	2.34	-	-	0.092	-
Y	-	2.34	-	-	0.092	-
θ	0°	-	8°	0°	-	8°

Mold flash shall not exceed 0.25mm per side
JEDEC outline: MS-012 BA