

Dual Low Dropout Linear Regulators

❖ GENERAL DESCRIPTION

The AX6637A/B/C/D is an efficient, precise dual-channel CMOS LDO regulator optimized for ultra-low-quiescent applications. Regulators output1 is capable of sourcing 900mA of output current and output2 is capable of sourcing 800mA of output current. The regulators are stable with output capacitors as low as 1 μ F, including current limit, thermal shutdown protection, fast transient response, low dropout voltage, high output accuracy, current limiting protection, and high ripple rejection ratio. The AX6637A/B/C/D regulators are available in used SOP-8L and TO252-5L Pb-Free Packages.

❖ FEATURES

- Input voltage range :
 - Channel1: 3.4V to 5.5V
 - Channel2: 2.8V to 5.5V
- Low Quiescent Current is 50uA (typ.)/per channel
- Fast transient response
- Tight Load and Line Regulation
- Current limit and thermal shutdown protection
- Only low-ESR Ceramic Capacitors Required for Stability
- Available in the SOP-8L and TO252-5L Pb-Free Packages

❖ BLOCK DIAGRAM

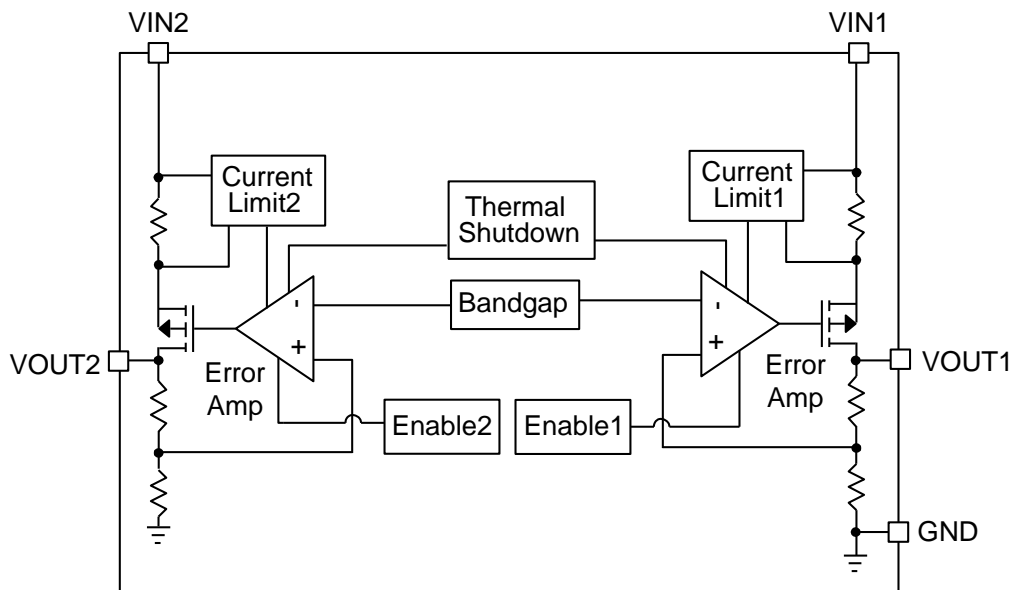

❖ PIN ASSIGNMENT

The packages of AX6637A/B/C/D are SOP-8L and TO252-5L; the pin assignment is given by:

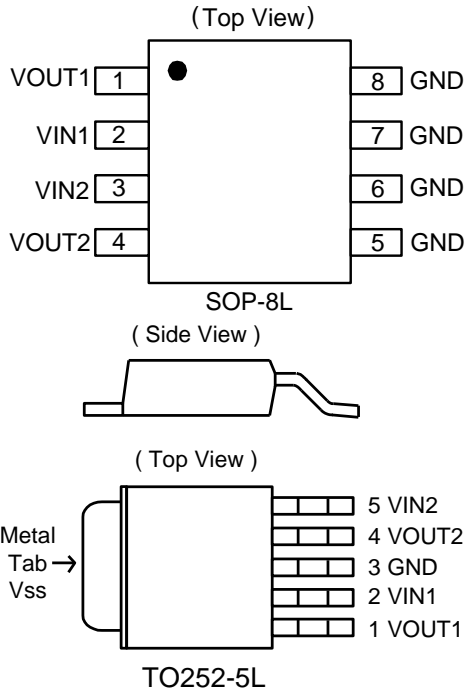

Name	Description
VIN1	Channel1 input Voltage
VIN2	Channel 2 input Voltage
VOUT1	Channel 1 Output Voltage
VOUT2	Channel 2 Output Voltage
GND	Common Ground

❖ ORDER/MARKING INFORMATION

Order Information	
AX6637 X XX X	
Output voltage A : $V_{OUT1}=3.3V, V_{OUT2}=1.8V$ B : $V_{OUT1}=3.3V, V_{OUT2}=1.5V$ C : $V_{OUT1}=3.3V, V_{OUT2}=1.2V$ D : $V_{OUT1}=3.3V, V_{OUT2}=1.25V$	Package S : SOP-8L D5 : TO252-5L
Packing Blank:Tube A : Taping	
Top Marking (SOP-8L)	Top Marking (TO252-5L)
Logo ← AX 6 6 3 7 → Part number X YY WW X → ID code:internal WW: 01~52 Year: 10=2010 11=2011 Functional code A:AX6637A B:AX6637B C:AX6637C D:AX6637D	Logo ← AX 6 6 3 7 → Part number X → Functional code A:AX6637A B:AX6637B C:AX6637C D:AX6637D YY WW X → ID code:internal WW: 01~52 Year: 10=2010 11=2011

❖ ABSOLUTE MAXIMUM RATINGS (at T_A=25°C)

Characteristics	Symbol	Rating	Unit
V _{IN1} , V _{IN2} Pin Voltage	V _{IN1,2}	6	V
Output Voltage	V _{OUT1} /V _{OUT2}	GND - 0.3 to V _{IN} + 0.3	V
Power Dissipation	PD	Internal Limited	W
Storage Temperature Range	T _{ST}	-65 to +150	°C
Operating Junction Temperature Range	T _{OPJ}	-40 to +125	°C
Junction Temperature	T _J	-40 to +150	°C
Thermal Resistance from Junction to case	θ _{JC}	TO252=10,SOP8=20	°C/W
Thermal Resistance from Junction to ambient	θ _{JA}	TO253=30,SOP8=60	°C/W

Note: θ_{JA} is measured with the PCB copper area of approximately 1 in²(Multi-layer). That need connect to tap pin(TO252) or GND pin (SOP8).

❖ ELECTRICAL CHARACTERISTICS

(V_{IN1} = V_{IN2} = 5V, T_A=25°C (unless otherwise noted))

Characteristics	Symbol	Conditions	Min	Typ	Max	Units	
Input Voltage (Note1)	V _{IN1}	I _{OUT1} =30mA	3.4	-	5.5	V	
	V _{IN2}	I _{OUT2} =30mA	2.8	-	5.5	V	
Temperature Shutdown	T _{SD1,2}		-	150	-	°C	
Temperature Shutdown Hysteresis	T _{SDR1,2}		-	40	-	°C	
Regulator1							
Output Voltage Accuracy	V _{OUT1}	I _{OUT1} =30mA	3.234	3.3	3.366	V	
Output Voltage Temperature stability		I _{OUT1} =10mA (Note 5)	-	1	-	%	
Dropout Voltage (Note 2)	V _{DROP1}	I _{OUT} =0.8A	-	400	600	mV	
Quiescent Current	I _{Q1}	I _{OUT1} =0mA, V _{IN1} =5V	-	50	80	uA	
Line Regulation	V _{Line1}	V _{IN1} = 4V to 5.5V, I _{OUT1} = 30mA	-	0.1	0.2	%/V	
Load Regulation	ΔV _{LOAD}	I _{OUT1} =10m~800mA	-	10	40	mV	
Current Limit	I _{LIMIT1}	V _{IN1} = 5.0V	900	-	-	mA	
Short Circuit Current	I _{short1}	V _{OUT1} <0.25*V _{OUT1}	-	500	-	mA	
Ripple Rejection	PSRR1	I _{OUT1} =30mA, F=100Hz	-	-60	-	dB	
Regulator2							
Output Voltage Accuracy	V _{OUT2}	I _{OUT2} =30mA (AX6637A)	1.764	1.8	1.836	V	
		I _{OUT2} =30mA (AX6637B)	1.470	1.5	1.530		
		I _{OUT2} =30mA (AX6637C)	1.176	1.2	1.224		
		I _{OUT2} =30mA (AX6637D)	1.225	1.25	1.275		
Output Voltage Temperature Stability		I _{OUT2} =10mA	-	1	-	%	
Dropout Voltage (Note 2)	V _{DROP2}	V _{OUT2} =1.8V	I _{OUT2} =0.7A	-	800	1200	mV
		V _{OUT2} =1.5V		-	1100	1500	
		V _{OUT2} =1.2V		-	1400	1800	

3/11

		$V_{OUT2}=1.25V$	-	1350	1750	
Quiescent Current	I_{Q1}	$I_{OUT2}=0mA, V_{IN2}=5V$	-	50	80	μA
Line Regulation	V_{Line1}	$V_{IN2}=3.0V \text{ to } 5.5V, I_{OUT2}=30mA$	-	0.1	0.2	%/V
Load Regulation (Note 3)	ΔV_{LOAD}	$I_{OUT2}=10m\sim 700mA$	-	10	40	mV
Current Limit (Note 4)	I_{LIMIT2}	$V_{IN2}=5.0V$	800	-	-	mA
Short Circuit Current	I_{short2}	$V_{OUT2}<0.25*V_{OUT2}$	-	500	-	mA
Ripple Rejection	PSRR2	$I_{OUT2}=30mA, F=100Hz$	-	-60	-	dB

Note1: The device is not guaranteed to function outside its operating conditions.

Note2: $V_{OUT1}=V_{OUT1}-2\%$; $V_{OUT2}=V_{OUT2}-2\%$

Note3: Regulation is measured at constant junction temperature by using pulsed testing with a low ON time.

Note4: Current limit is measured at constant junction temperature by using pulsed testing with a low ON time.

Note5: Guaranteed by design.

❖ APPLICATION CIRCUIT

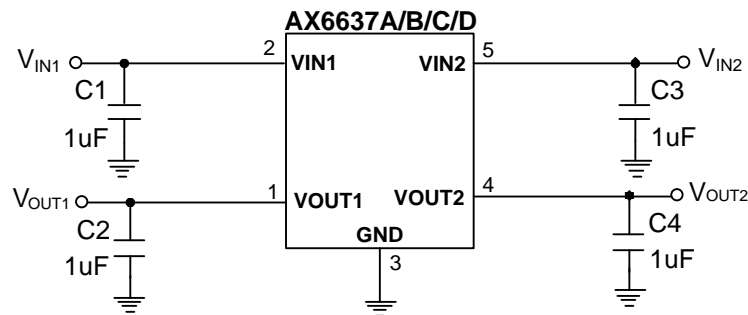

❖ FUNCTION DESCRIPTIONS

The AX6637A/B/C/D is a highly accurate, dual, low noise, CMOS LDO voltage regulators with enable function. The output voltage for each regulator is set independently by fuse trimming. As illustrated in function block diagram, it consists of a reference, error amplifier, a P-channel pass transistor. The band gap reference is connected to the error amplifier, which compares the reference with the feedback voltage and amplifies the voltage difference. If the feedback voltage is lower than the reference voltage, the pass-transistor gate is pulled lower, which allows more current to pass to the V_{OUT} pin and increases the output voltage. If the feedback voltage is too high, the pass transistor gate is pulled up to decrease the output voltage. The output voltage is feed back through an internal resistive divider connected to V_{OUT} pin. Additional blocks include an output current limiter, thermal sensor, and shutdown logic.

Dropout Voltage

A regulator's minimum input-output voltage differential, or dropout voltage, determines the lowest usable supply voltage. The AX6637A/B/C/D use a P- channel MOSFET pass transistor, its dropout voltage is function of drain-to-source on-resistance $R_{DS(ON)}$ multiplied by the load current.

$$V_{DROPOUT} = V_{IN} - V_{OUT} = R_{DS(ON)} * I_{OUT}$$

Current Limit

Each channel of AX6637A/B/C/D includes a fold back current limiter. It monitors and controls the pass transistor's gate voltage, estimates the output current, and limits the output1 current minimum 900mA, output2 current minimum 800mA.

Thermal Shutdown Protection

Thermal Shutdown protection limits total power dissipation of AX6637A/B/C/D. When the junction temperature exceeds $T_J = +150^{\circ}\text{C}$, a thermal sensor turns off the pass transistor, allowing the IC to cool down. The thermal sensor turns the pass transistor on again after the junction temperature cools down by 40°C , resulting in a pulsed output during continuous thermal shutdown conditions.

Thermal shutdown protection is designed to protect the AX6637A/B/C/D in the event of fault conditions. For continuous operation, the absolute maximum operating junction temperature rating of $T_J = +125^{\circ}\text{C}$ should not be exceeded.

❖ APPLICATION INFORMATION

Like any low-dropout regulator, the AX6637A/B/C/D requires input and output decoupling capacitors. The device is specifically designed for portable applications requiring minimum board space and smallest components. These capacitors must be correctly selected for good performance (see Capacitor Characteristics Section). Please note that linear regulators with a low dropout voltage have high internal loop gains which require care in guarding against oscillation caused by insufficient decoupling capacitance.

Input Capacitor

An input capacitance of $1\mu\text{F}$ is required between input pin and ground directly (the amount of the capacitance may be increased without limit). The input capacitor must be located less than 1cm from the device to assure input stability. A lower ESR capacitor allows the use of less capacitance, while higher ESR type (like aluminum electrolytic) requires more capacitance. Capacitor types (aluminum, ceramic and tantalum) can be mixed in parallel, but the total equivalent input capacitance/ ESR must be defined as above to stable operation. There are no requirements for the ESR on the input capacitor, but tolerance and temperature coefficient must be considered when selecting the capacitor to ensure the capacitance will be $1\mu\text{F}$ over the entire operating temperature range.

Output Capacitor

The AX6637A/B/C/D is designed specifically to work with very small ceramic output capacitors. A ceramic capacitor (temperature characteristics X7R, X5R) in 1 μ F is suitable for the AX6637A/B/C/D application. The recommended minimum capacitance for the device is 1 μ F, X5R or X7R dielectric ceramic, between V_{OUT} and GND for stability, but it may be increased without limit. Higher capacitance values help to improve transient. The output capacitor's ESR is critical because it forms a zero to provide phase lead which is required for loop stability.

Thermal Considerations

The AX6637A/B/C/D series can deliver a current of up to 900mA of channel1, 800mA of channel2 over the full operating junction temperature range. However, the maximum output current must be debated at higher ambient temperature to ensure the junction temperature does not exceed 125°C. With all possible conditions, the junction temperature must be within the range specified under operating conditions. Power dissipation can be calculated based on the output current and the voltage drop across regulator.

$$P_D = (V_{IN} - V_{OUT}) I_{OUT} + V_{IN} I_{GND}$$

The final operating junction temperature for any set of conditions can be estimated by the following thermal equation:

$$P_{D(MAX)} = (T_{J(MAX)} - T_A) / \theta_{JA}$$

Where T_{J(MAX)} is the maximum junction temperature of the die (125°C) and T_A is the maximum ambient temperature. The junction to ambient thermal resistance (θ_{JA}) TO252-5L package at recommended minimum footprint is 30°C/W that is connect 1 in² PCB copper area to exposed pad.

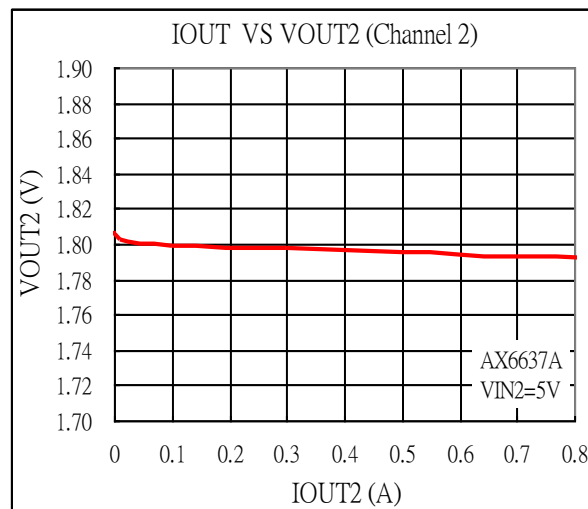
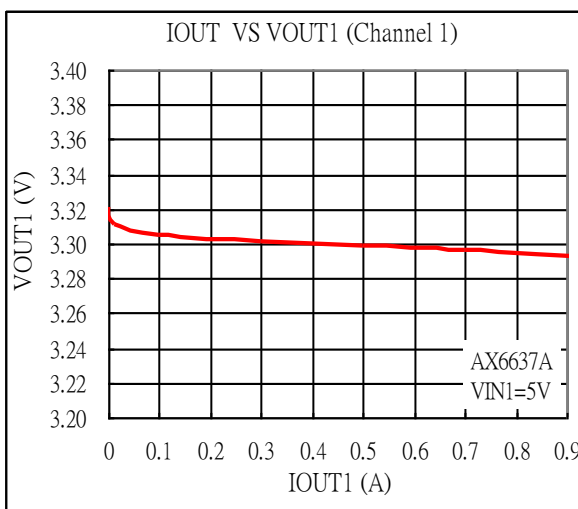
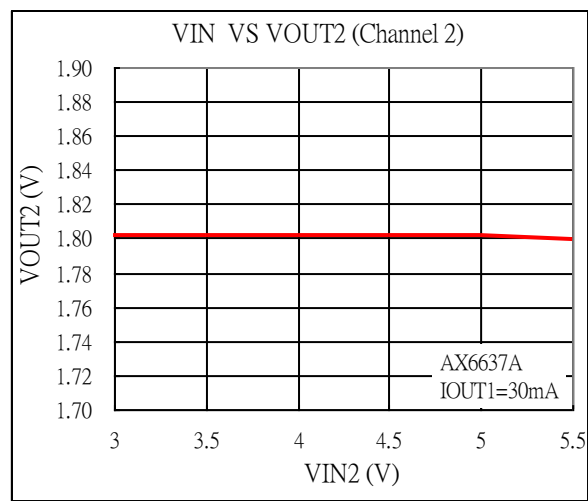
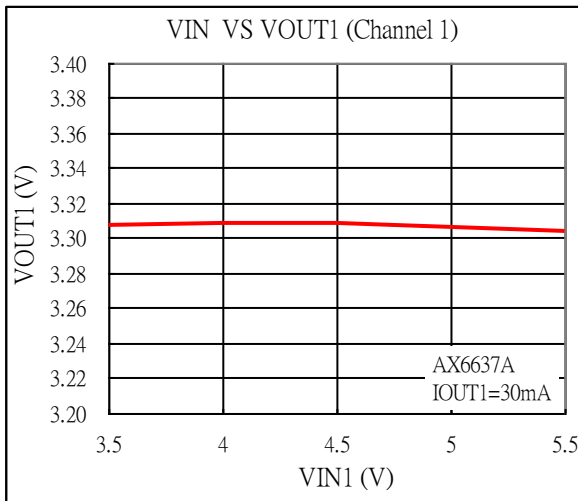
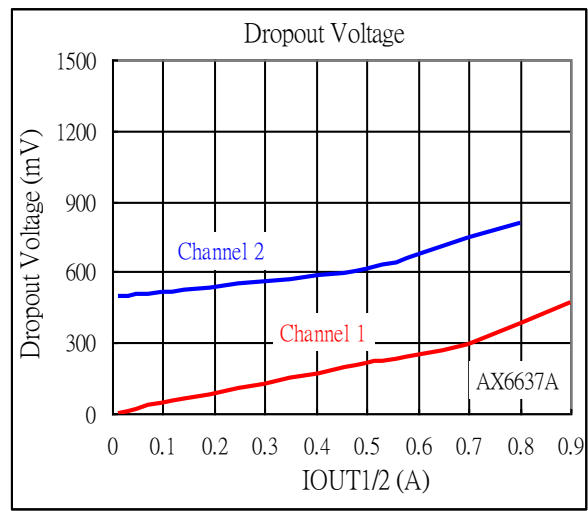
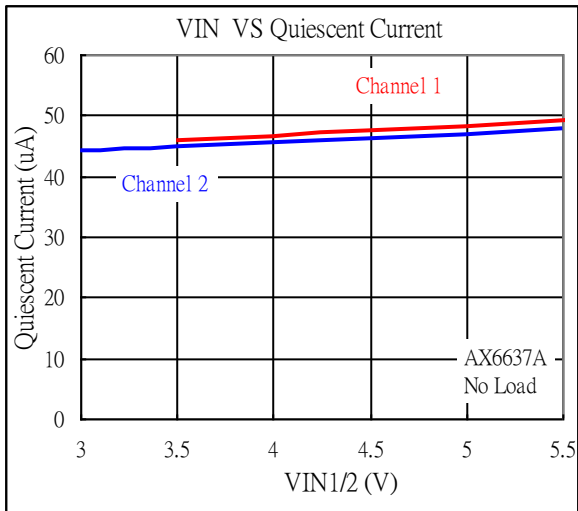
❖ TYPICAL CHARACTERISTICS

❖ TYPICAL CHARACTERISTICS (CONTINUOUS)

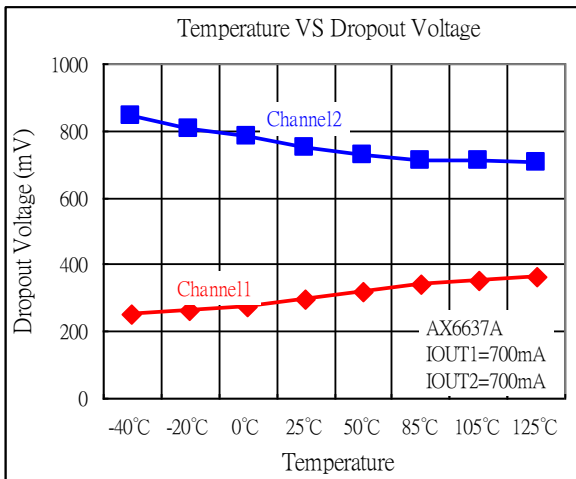
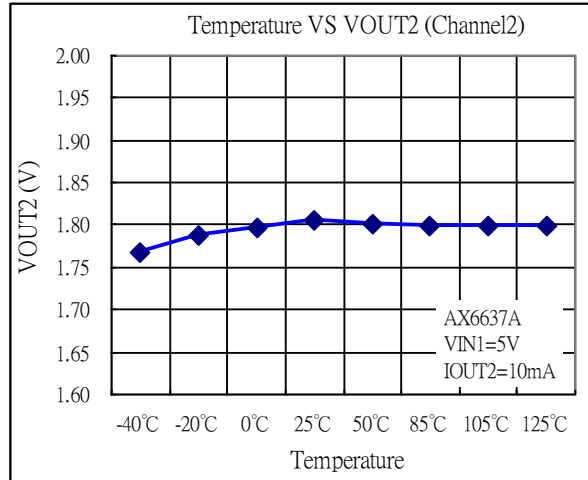
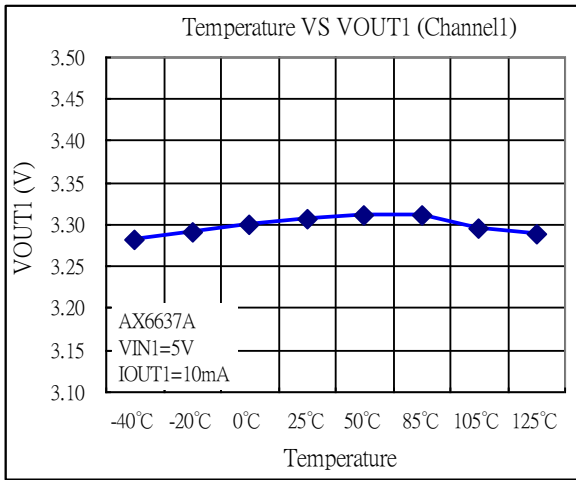

❖ TYPICAL CHARACTERISTICS (CONTINUOUS)

Power ON Test (Channel1)

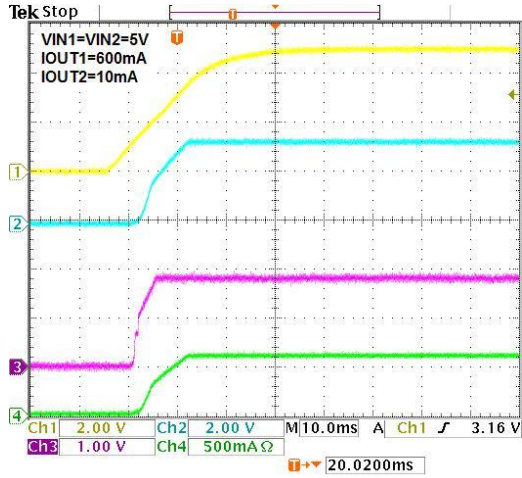

Power ON Test (Channel2)

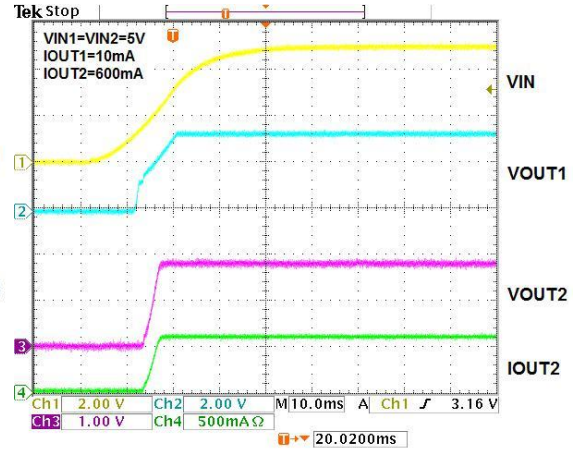

Load Transient (Channel 1)

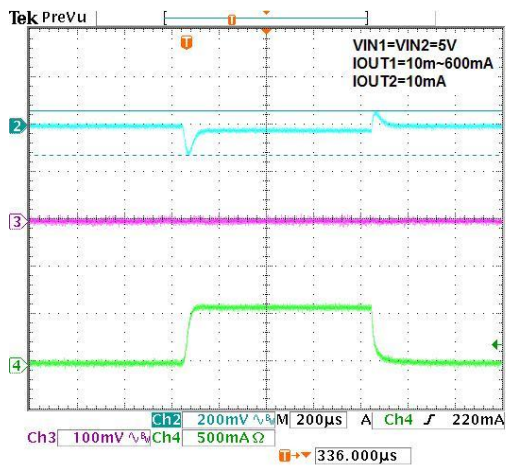

Load Transient (Channel 2)

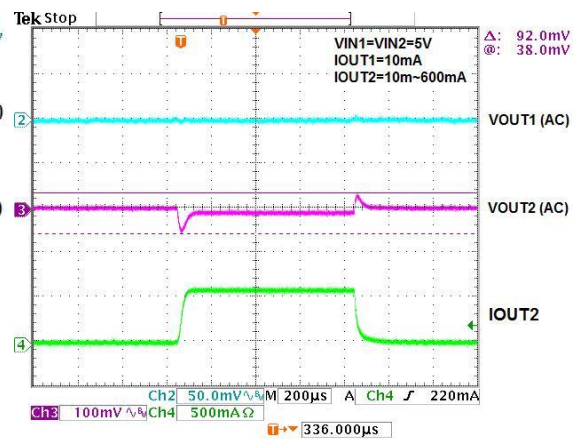

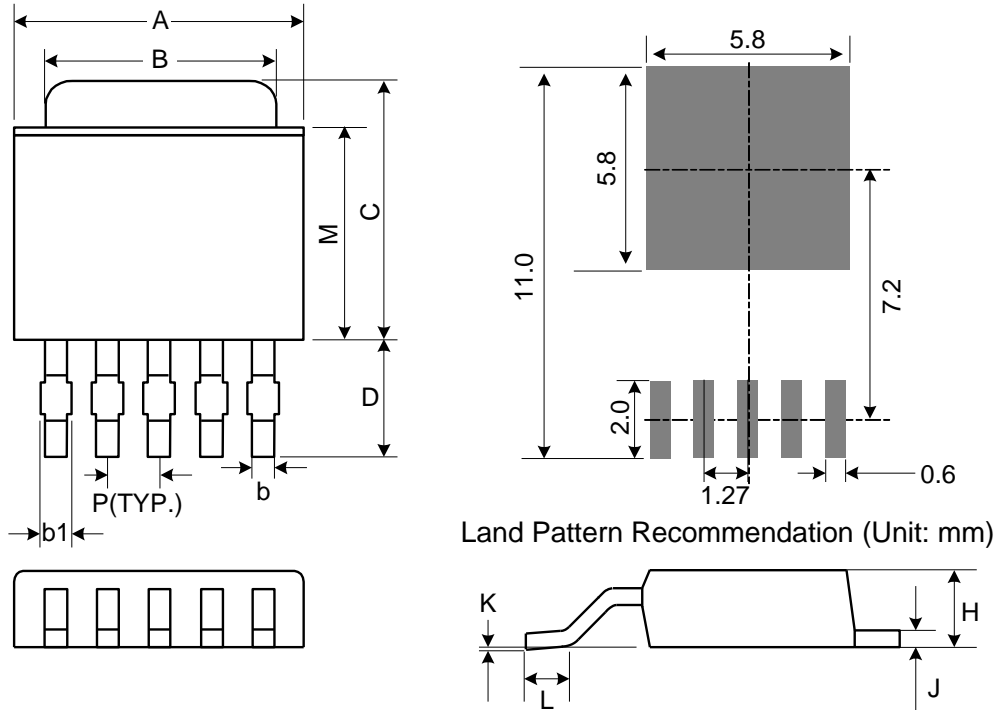
❖ PACKAGE OUTLINES
(1) TO252-5L

Symbol	Dimensions in Millimeters			Dimensions in Inches		
	Min.	Nom.	Max.	Min.	Nom.	Max.
A	6.35	6.6	6.73	0.250	0.260	0.265
B	5.21	5.33	5.46	0.205	0.210	0.215
C	6.86	7.24	7.62	0.270	0.285	0.300
D	2.67 REF			0.105 REF		
P	1.27 REF			0.050 REF		
H	2.18	2.29	2.39	0.086	0.090	0.094
J	0.46	0.51	0.58	0.018	0.020	0.023
K	0.00	0.08	0.13	0.000	0.003	0.005
L	1.40	1.60	1.78	0.055	0.063	0.070
M	5.33	5.46	5.59	0.210	0.215	0.220
b	0.38	0.56	0.71	0.015	0.022	0.028
b1	0.38	0.53	0.66	0.015	0.021	0.026

Mold flash shall not exceed 0.005inch per side

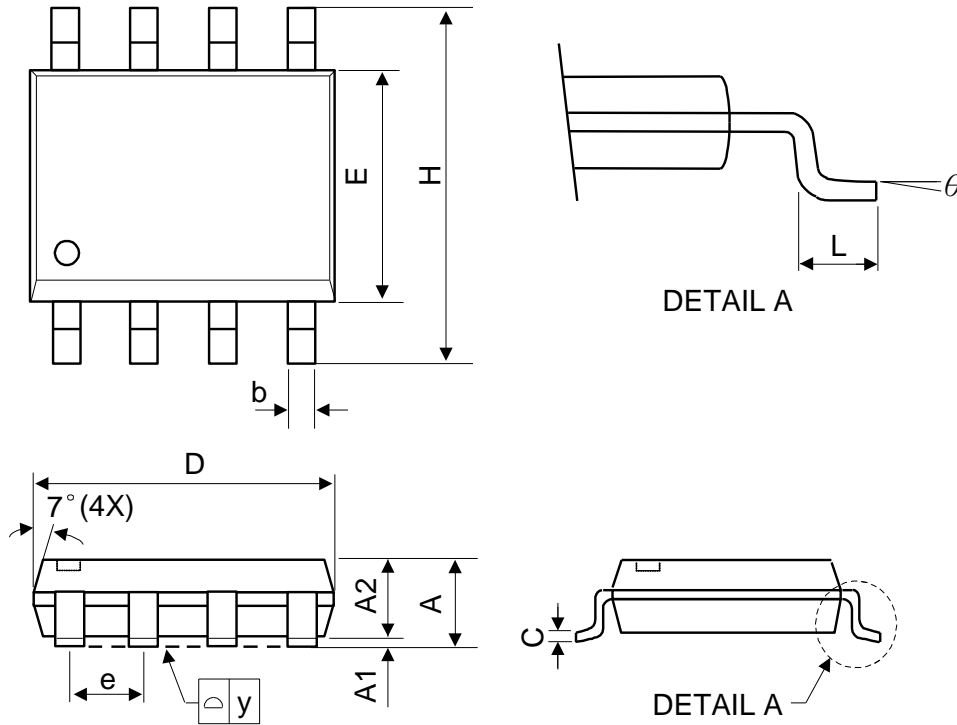
(2) SOP-8L

Symbol	Dimensions in Millimeters			Dimensions in Inches		
	Min.	Nom.	Max.	Min.	Nom.	Max.
A	-	-	1.75	-	-	0.069
A1	0.1	-	0.25	0.04	-	0.1
A2	1.25	-	-	0.049	-	-
C	0.1	0.2	0.25	0.0075	0.008	0.01
D	4.7	4.9	5.1	0.185	0.193	0.2
E	3.7	3.9	4.1	0.146	0.154	0.161
H	5.8	6	6.2	0.228	0.236	0.244
L	0.4	-	1.27	0.015	-	0.05
b	0.31	0.41	0.51	0.012	0.016	0.02
e	1.27 BSC			0.050 BSC		
y	-	-	0.1	-	-	0.004
θ	0°	-	8°	0°	-	8°

Mold flash shall not exceed 0.25mm per side
JEDEC outline: MS-012 AA