

600mA High PSRR LDO Linear Regulator with Shutdown

❖ GENERAL DESCRIPTION

The AX6647 is a low dropout, positive linear regulator with very low quiescent. It can supply 600mA output current. The BP pin with a 10nF bypass capacitor can help reduce the output noise level. The characteristics of low dropout voltage and less quiescent current make it good for some critical current application, for example, some battery powered devices. The typical quiescent current is approximately 50 μ A. In the shutdown mode, the maximum supply current is less than 1 μ A. The AX6647 regulator is able to operate with output capacitors as small as 2.2 μ F for stability. The AX6647 series are offering several fixed output voltage types including 1.0V, 1.1V, 1.2V, 1.5V, 1.8V, 2.5V, 2.6V, 2.7V, 2.8V, 3.0V, 3.3V and adjustable version. Built-in current-limit and thermal-shutdown functions prevent any fault condition from IC damage.

❖ FEATURES

- Input voltage range : 2.6V~6V
- Adjustable and 1.0/1.1/1.2/1.5/1.8/2.5/2.6/2.7/2.8/3.0/3.3V fixed output voltages
- VOUT adjust range from V_{FB} to 5.0V (Adjustable Version Only)
- Guaranteed 600mA output current
- Very Low quiescent current at 50 μ A (typ.)
- Needs Only 2.2 μ F capacitor for Stability
- Maximum supply current in shutdown mode <1 μ A
- Current limit and thermal shutdown protection
- Short circuit current fold-back
- Available in the TSOT-23-5L, TDFN-6L, SOT89-3L and SOT223-3L Pb-Free Packages

❖ BLOCK DIAGRAM

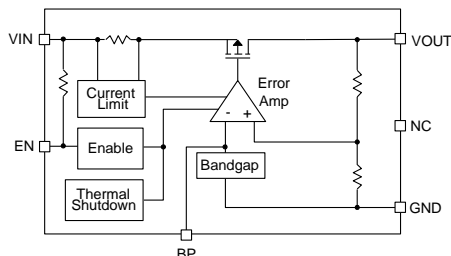

Fixed Version

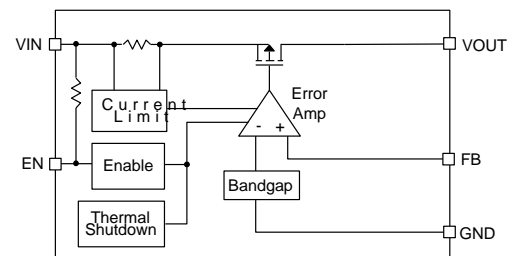

Adjustable Version

❖ **PIN ASSIGNMENT**

The packages of AX6647 are TSOT-23-5L, TDFN-6L, SOT89-3L and SOT223-3L; the pin assignment is given by:

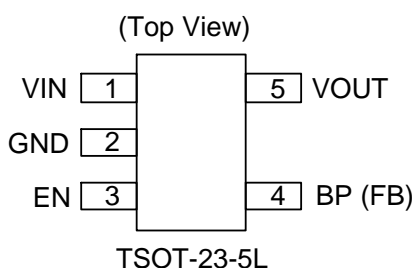

Adjustable Version: Pin 4 is FB
Fixed Version: Pin 4 is BP

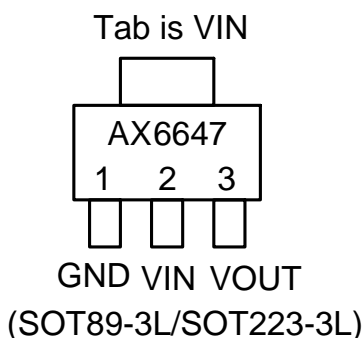
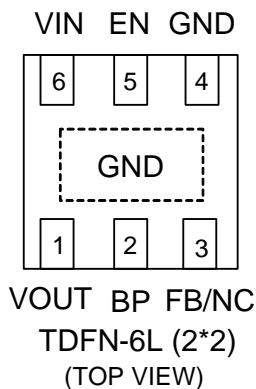

Name	Description
VIN	Voltage input. The input capacitor in the range of 1μF to 10μF is sufficient.
GND	Ground
EN	Enable pin (Active High)
BP	Reference Noise Bypass (The Bypass capacitor $\geq 1nF$)
VOUT	Output Voltage, The AX6647 is stable with an output capacitor 2.2μF for greater.
FB	For adjustable output voltage version only, the pin connects two resistances to decide output voltage.
NC	When use fixed output voltage version, this pin is NC pin. (TDFN Only)

❖ ORDER/MARKING INFORMATION

Order Information																																								
AX6647 XX XX X <div style="display: flex; justify-content: space-around; margin-top: 10px;"> <div style="border: 1px solid black; padding: 5px; width: 30%;">Output voltage</div> <div style="border: 1px solid black; padding: 5px; width: 30%;">Package</div> <div style="border: 1px solid black; padding: 5px; width: 30%;">Packing</div> </div> <div style="margin-top: 10px;"> <table style="width: 100%; border-collapse: collapse;"> <tr> <td style="width: 33%;">Blank : ADJ</td> <td style="width: 33%;">BT : TSOT-23-5L</td> <td style="width: 33%;">Blank: Bag</td> </tr> <tr> <td>10 : 1.0V</td> <td>Z6 : TDFN-6L(2*2)</td> <td>A : Taping</td> </tr> <tr> <td>11 : 1.1V</td> <td>F : SOT89-3L</td> <td></td> </tr> <tr> <td>12 : 1.2V</td> <td>E : SOT223-3L</td> <td></td> </tr> <tr> <td>15 : 1.5V</td> <td></td> <td></td> </tr> <tr> <td>18 : 1.8V</td> <td></td> <td></td> </tr> <tr> <td>25 : 2.5V</td> <td></td> <td></td> </tr> <tr> <td>26 : 2.6V</td> <td></td> <td></td> </tr> <tr> <td>27 : 2.7V</td> <td></td> <td></td> </tr> <tr> <td>28 : 2.8V</td> <td></td> <td></td> </tr> <tr> <td>29 : 2.9V</td> <td></td> <td></td> </tr> <tr> <td>30 : 3.0V</td> <td></td> <td></td> </tr> <tr> <td>33 : 3.3V</td> <td></td> <td></td> </tr> </table> </div>		Blank : ADJ	BT : TSOT-23-5L	Blank: Bag	10 : 1.0V	Z6 : TDFN-6L(2*2)	A : Taping	11 : 1.1V	F : SOT89-3L		12 : 1.2V	E : SOT223-3L		15 : 1.5V			18 : 1.8V			25 : 2.5V			26 : 2.6V			27 : 2.7V			28 : 2.8V			29 : 2.9V			30 : 3.0V			33 : 3.3V		
Blank : ADJ	BT : TSOT-23-5L	Blank: Bag																																						
10 : 1.0V	Z6 : TDFN-6L(2*2)	A : Taping																																						
11 : 1.1V	F : SOT89-3L																																							
12 : 1.2V	E : SOT223-3L																																							
15 : 1.5V																																								
18 : 1.8V																																								
25 : 2.5V																																								
26 : 2.6V																																								
27 : 2.7V																																								
28 : 2.8V																																								
29 : 2.9V																																								
30 : 3.0V																																								
33 : 3.3V																																								
Top Marking (TSOT-23-5L)	Top Marking (TDFN-6L)																																							
<p style="text-align: center;">LLYWX → ID code: internal</p> <div style="display: flex; justify-content: space-between; align-items: center;"> <div style="text-align: center;"> <p>↓</p> <p>Identification code</p> </div> <div style="text-align: right;"> <p>WW: 01~26(A~Z) 27~52(a~z)</p> <p>Year: A= 2010 1= 2011 ⋮ 9 = 2019</p> </div> </div>	<p style="text-align: center;">LL → Output type Refer Identification Code</p> <p style="text-align: center;">YWX → ID Code: Internal</p> <div style="display: flex; justify-content: space-between; align-items: center;"> <div style="text-align: center;"> <p>↓</p> <p>Identification code</p> </div> <div style="text-align: right;"> <p>Week: 01~26(A~Z) 27~52(a~z)</p> <p>Year : A = 2010 1 = 2011 ⋮ 9 = 2019</p> </div> </div>																																							
Top Marking (SOT89-3L)	Top Marking (SOT223-3L)																																							
<p style="text-align: center;">6 6 4 7 → Part Number</p> <p style="text-align: center;">LYWX</p> <div style="display: flex; justify-content: space-between; align-items: center;"> <div style="text-align: center;"> <p>↓</p> <p>Identification Code</p> </div> <div style="text-align: right;"> <p>→ ID code: internal</p> <p>WW: 01~26(A~Z) 27~52(a~z)</p> <p>Year: A=2010 1=2011 ⋮ 9=2019</p> </div> </div>	<p style="text-align: center;">AX 6 6 4 7</p> <div style="display: flex; justify-content: space-between; align-items: center;"> <div style="text-align: center;"> <p>↓</p> <p>Identification Code</p> </div> <div style="text-align: right;"> <p>→ Output Voltage AX6647-10: 1.0V AX6647-11: 1.1V ⋮ AX6647-33: 3.3V</p> <p>→ ID code: internal</p> <p>WW: 01~52</p> <p>Year: A= 2010 1= 2011 ⋮ 9= 2019</p> </div> </div>																																							

Appendix

Part Number	Identification Code	Part Number	Identification Code
AX6647-ADJ	Ak	AX6647-2.6V	As
AX6647-1.0V	Al	AX6647-2.7V	At
AX6647-1.1V	Am	AX6647-2.8V	Au
AX6647-1.2V	An	AX6647-2.9V	Av
AX6647-1.5V	Ap	AX6647-3.0V	Aw
AX6647-1.8V	Aq	AX6647-3.3V	Ax
AX6647-2.5V	Ar		

❖ ABSOLUTE MAXIMUM RATINGS (at $T_A=25\text{ }^\circ\text{C}$)

Characteristics		Symbol	Rating	Unit
V _{IN} Pin Voltage		V _{IN}	GND - 0.3 to 7	V
Output Voltage		V _{OUT}	GND - 0.3 to 7	V
Enable Voltage		V _{EN}	GND - 0.3 to 7	V
Feedback Voltage		V _{FB}	GND - 0.3 to 7	V
Power Dissipation		PD	$PD=(T_J-T_A) / \theta_{JA}$	W
Storage Temperature Range		T _{ST}	-40 to +150	°C
Operating Temperature Range		T _{OP}	-40 to +85	°C
Junction Temperature		T _J	-40 to +125	°C
Thermal Resistance from Junction to case	TSOT-23-5L	θ_{JC}	130	°C/W
	TDFN-6L		20	
	SOT89-3L		48	
	SOT223-3L		15	
Thermal Resistance from Junction to ambient	TSOT-23-5L	θ_{JA}	250	°C/W
	TDFN-6L		165	
	SOT89-3L		175	
	SOT223-3L		115	

Note: θ_{JA} is measured with the PCB copper area of approximately 1 in²(Multi-layer). That need connect to GND (exposed pad) pin.

❖ ELECTRICAL CHARACTERISTICS ($V_{IN}=5V$, $T_A=25\text{ }^\circ\text{C}$, unless otherwise noted)

Characteristics	Symbol	Conditions	Min	Typ	Max	Units	
Input Voltage	V_{IN}	$I_{OUT}=30\text{mA}$ (Note1)	2.6	-	6	V	
Quiescent Current	I_Q	$I_{OUT}=0\text{mA}$	-	50	80	μA	
Shutdown Current	I_{SD}	$V_{IN}=3.6\text{V}$, $I_{OUT}=0\text{mA}$, $V_{EN}=0\text{V}$	-	-	1	μA	
Output Voltage Accuracy (Fixed Version Only)	ΔV_{OUT}	$V_{IN}=V_{OUT}+0.1\text{V}$ to 6V $V_{OUT}\geq 2.5\text{V}$, $I_{OUT}=1\text{mA}$	-2	-	+2	%	
		$V_{IN}=2.6\text{V}$ to 6V $2.5\text{V}>V_{OUT}\geq 1.0\text{V}$, $I_{OUT}=1\text{mA}$	-3	-	+3		
Feedback Voltage	V_{FB}	$V_{IN}=2.6\text{V}$ to 6V, $I_{OUT}=1\text{mA}$	0.784	0.8	0.816	V	
FB Input Leakage Current	I_{FB}	$V_{FB}=0.8\text{V}$	-100	-	100	nA	
Dropout Voltage (Note2)	V_{DROP}	$I_{OUT}=500\text{mA}$	$V_{OUT}=1.0\text{V}$	-	1600	1900	mV
			$V_{OUT}=1.2\text{V}$	-	1400	1700	
			$V_{OUT}=1.5\text{V}$	-	1200	1500	
			$V_{OUT}=1.8\text{V}$	-	900	1200	
			$V_{OUT}=2.5\text{V}$	-	600	800	
			$V_{OUT}=3.3\text{V}$	-	400	600	
Current Limit	I_{LIMIT}		700	-	-	mA	
Short Circuit Current	I_{SHORT}	Output Voltage < $0.25*V_{OUT}$	-	300	-	mA	
Load Regulation (Note 3)	ΔV_{LOAD}	$I_{OUT}=10\text{m}\sim 0.6\text{A}$	-	40	70	mV	
Ripple Rejection	PSRR	$C_{IN}=1\mu\text{F}$, $C_{OUT}=2.2\mu\text{F}$, $I_{OUT}=10\text{mA}$	F=120Hz	-	70	-	dB
			F=1KHz	-	60	-	
Enable Input Threshold	V_{ENH}		2.0	-	-	V	
	V_{ENL}		-	-	0.4		
Enable Pin Current	I_{ENH}	$V_{EN}=V_{IN}$	-	0.003	0.1	μA	
	I_{ENL}	$V_{IN}=3.6\text{V}$, $V_{EN}=0\text{V}$	-	0.35	1		
Temperature Shutdown	T_S		-	140	-	$^\circ\text{C}$	
Temperature Shutdown Hysteresis	T_{SH}		-	30	-	$^\circ\text{C}$	

Note1. Minimum V_{IN} voltage is defined by output adds a dropout voltage.

Note2. The dropout voltage is defined as $V_{IN}-V_{OUT}$, which is measured when V_{OUT} drop about 100mV.

Note3. Regulation is measured at constant junction temperature by using pulsed testing with a low ON time.

❖ APPLICATION CIRCUIT

(1) Fixed Output Voltage Version

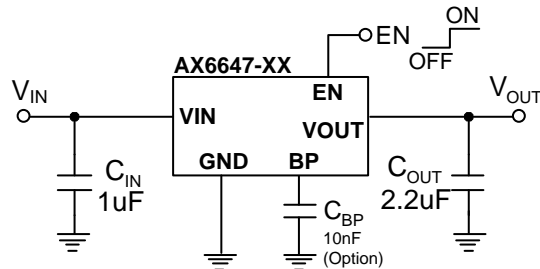

(2) Adjustable Output Voltage Version (TDFN Only)

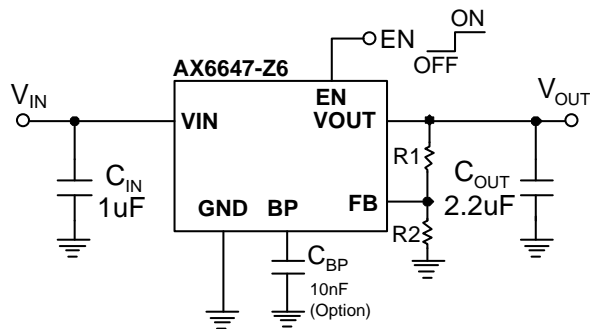

$$V_{OUT} = V_{FB} * (1 + R1/R2)$$

$$V_{FB} = 0.8V$$

$$R2 \text{ Range} = 50K \sim 300K$$

❖ FUNCTION DESCRIPTIONS

A minimum of 2.2μF capacitor must be connected from V_{OUT} to ground to insure stability. Typically a large storage capacitor is connected from V_{IN} to ground to ensure that the input voltage does not sag below the minimum dropout voltage during the load transient response. This pin must always be dropout voltage higher than V_{OUT} in order for the device to regulate properly.

❖ APPLICATION INFORMATION

Like any low-dropout regulator, the AX6647 requires input and output decoupling capacitors. The device is specifically designed for portable applications requiring minimum board space and smallest components. These capacitors must be correctly selected for good performance. Please note that linear regulators with a low dropout voltage have high internal loop gains which require care in guarding against oscillation caused by insufficient decoupling capacitance.

Capacitor Selection

Normally, use a 1μF capacitor on the input and a 2.2μF capacitor on the output of the AX6647. Larger input capacitor values and lower ESR (X5R, X7R) provide better supply-noise rejection and transient response. A higher- value output capacitor (2.2μF) may be necessary if large, fast transients are anticipated and the device is located several inches from the power source.

Input-Output (Dropout) Voltage

A regulator's minimum input-to-output voltage differential (dropout voltage) determines the lowest usable supply voltage. In battery-powered systems, this determines the useful end-of-life battery voltage. Because the device uses a PMOS, its dropout voltage is a function of drain-to source on-resistance, R_{DS (ON)}, multiplied by the load current:

$$V_{\text{DROPOUT}} = V_{\text{IN}} - V_{\text{OUT}} = R_{\text{DS (ON)}} \times I_{\text{OUT}}$$

Current Limit and Thermal Shutdown Protection

In order to prevent overloading or thermal condition from damaging the device, AX6647 regulator has internal thermal and current limiting functions designed to protect the device. It will rapidly shut off PMOS pass element during overloading or over temperature condition.

Thermal Considerations

The AX6647 series can deliver a current of up to 600mA over the full operating junction temperature range. However, the maximum output current must be dated at higher ambient temperature to ensure the junction temperature does not exceed 125°C. With all possible conditions, the junction temperature must be within the range specified under operating conditions. Power dissipation can be calculated based on the output current and the voltage drop across regulator.

$$PD = (V_{IN} - V_{OUT}) I_{OUT}$$

The final operating junction temperature for any set of conditions can be estimated by the following thermal equation:

$$PD (MAX) = (T_{J(MAX)} - T_A) / \theta_{JA}$$

Where $T_{J(MAX)}$ is the maximum junction temperature of the die (125°C) and T_A is the maximum ambient temperature. The junction to ambient thermal resistance (θ_{JA}) for TDFN-6L package at recommended minimum footprint is 120°C/W.

PCB Layout

An input capacitance of $\cong 1\mu F$ is required between the AX6647 input pin and ground (the amount of the capacitance may be increased without limit), this capacitor must be located a distance of not more than 1cm from the input and return to a clean analog ground. Input capacitor can filter out the input voltage spike caused by the surge current due to the inductive effect of the package pin and the printed circuit board's routing wire. Otherwise, the actual voltage at the VIN pin may exceed the absolute maximum rating. The output capacitor also must be located a distance of not more than 1cm from output to a clean analog ground. Because it can filter out the output spike caused by the surge current due to the inductive effect of the package pin and the printed circuit board's routing wire.

❖ TYPICAL CHARACTERISTICS

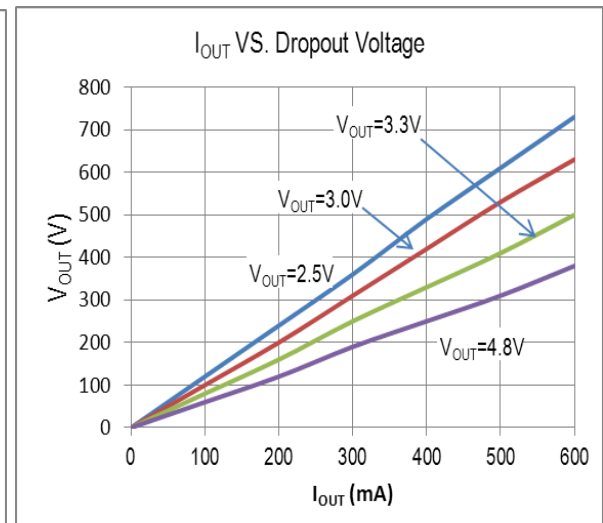
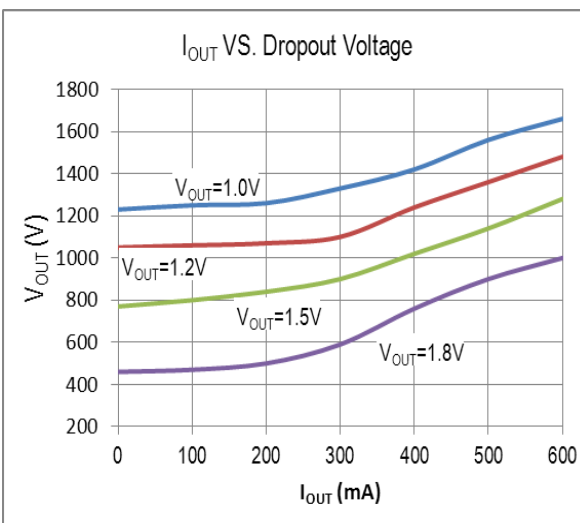
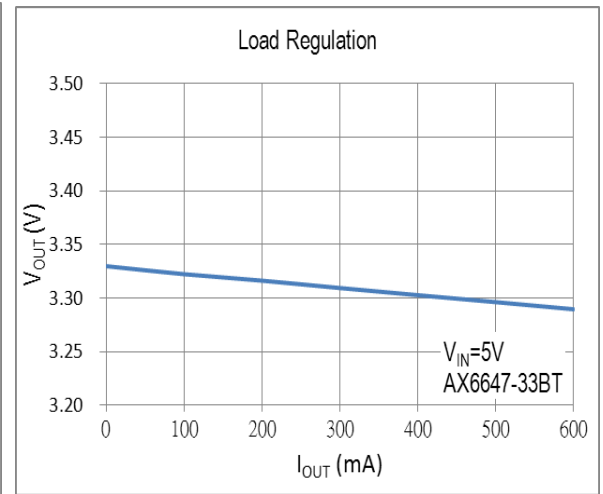
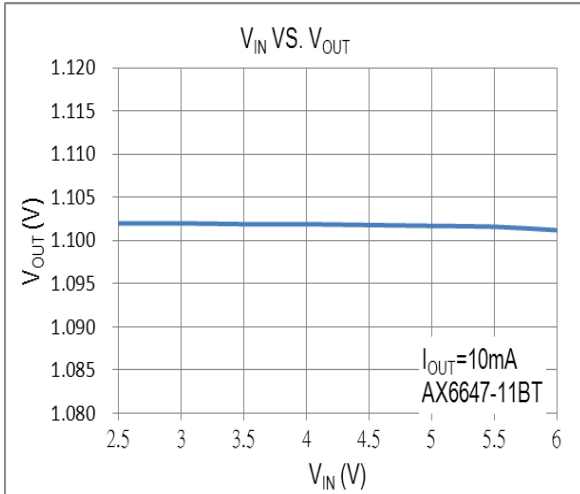
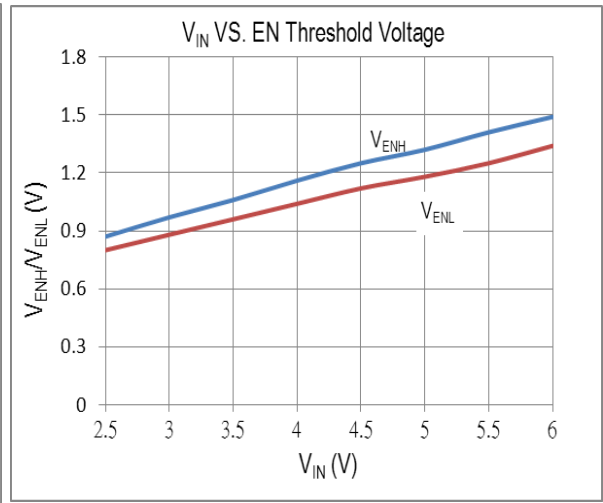
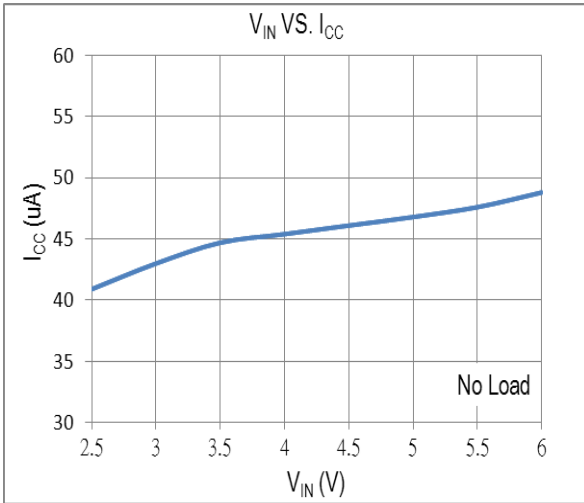

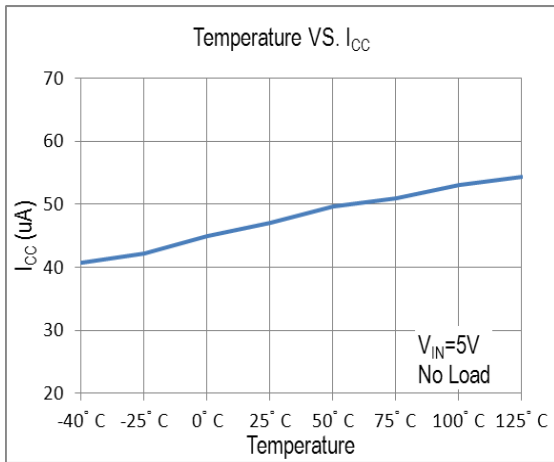
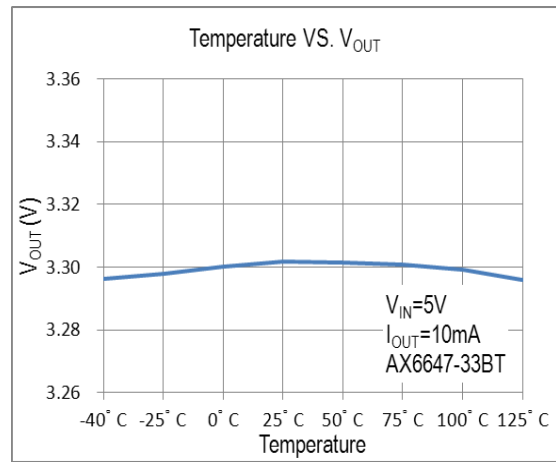
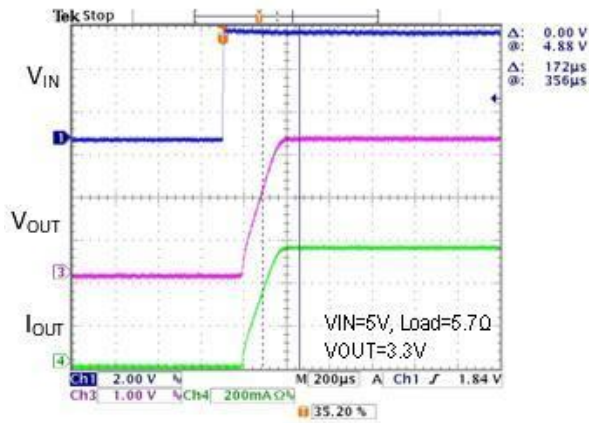
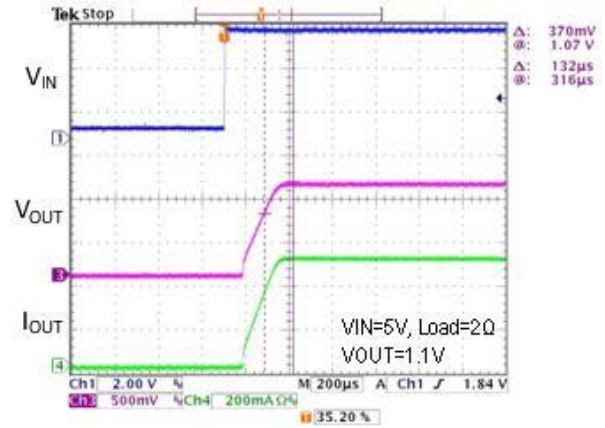
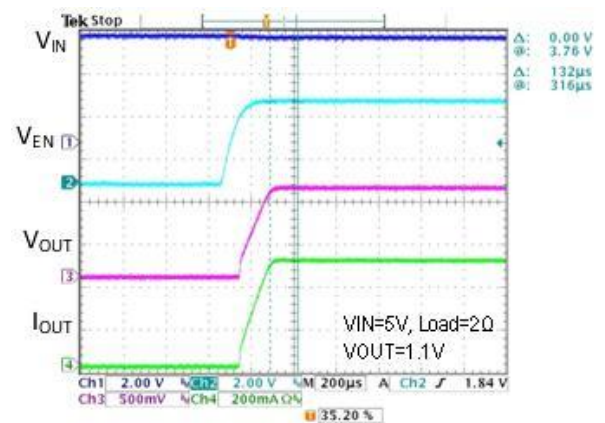
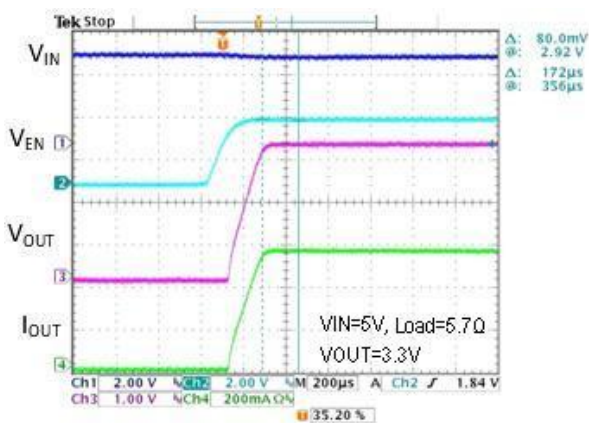
❖ TYPICAL CHARACTERISTICS (CONTINUOUS)

 Power ON ($C_{BP}=NC$)

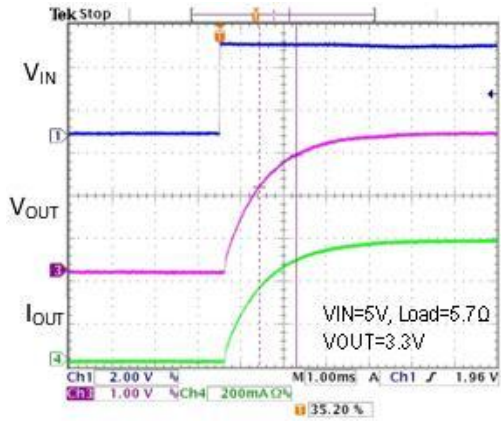
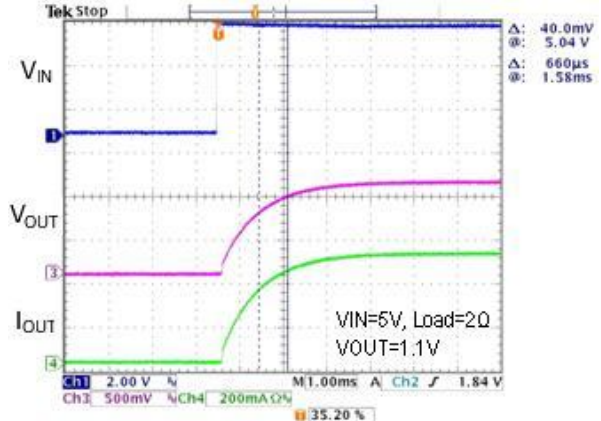
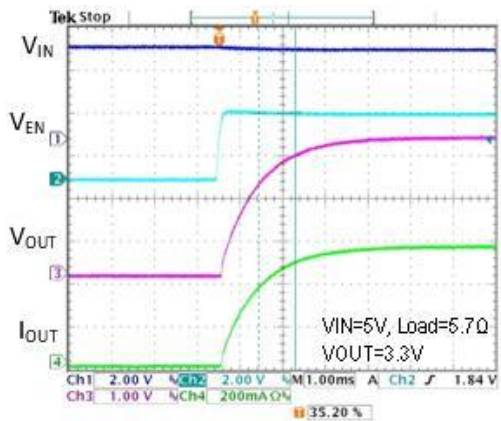
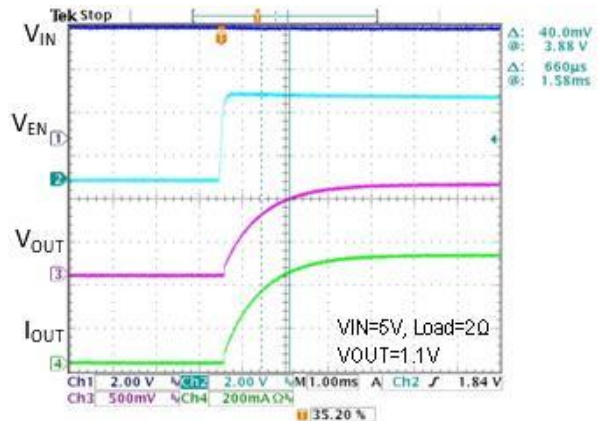
 Power ON ($C_{BP}=NC$)

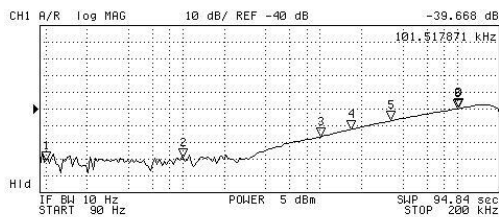
 EN ON ($C_{BP}=NC$)

 EN ON ($C_{BP}=NC$)

❖ TYPICAL CHARACTERISTICS (CONTINUOUS)

 Power ON ($C_{BP}=10nF$)

 Power ON ($C_{BP}=10nF$)

 EN ON ($C_{BP}=10nF$)

 EN ON ($C_{BP}=10nF$)

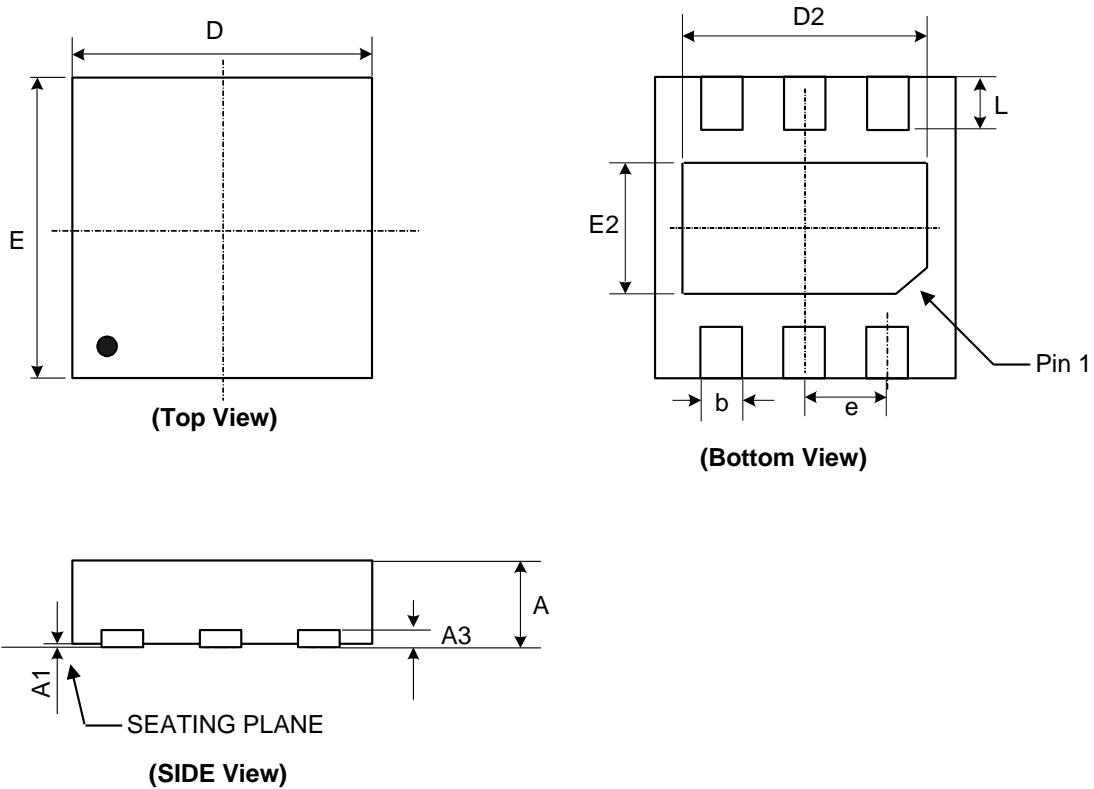
PSRR

 ($V_{IN}=5V$, $V_{OUT}=1.1V$, $C_{BP}=10nF$, $I_{OUT}=100mA$)

N	SWP PARAM	VAL
0	101.517871 kHz	-39.668 dB
1	100 Hz	-71.164 dB
2	1 kHz	-69.653 dB
3	10 kHz	-56.646 dB
4	16.672812 kHz	-52.279 dB
5	32.439206 kHz	-47.111 dB
6	100 kHz	-39.764 dB

 SELECT LETTER
 SPACE
 BACK SPACE
 ERASE TITLE
 DONE
 STOP DEV [DISK]
 CANCEL

❖ PACKAGE OUTLINES
(1) TDFN-6L (2*2 0.75mm)

Symbol	Dimensions in Millimeters			Dimensions in Inches		
	Min.	Nom.	Max.	Min.	Nom.	Max.
A	0.70	0.75	0.80	0.028	0.030	0.031
A1	0.00	0.02	0.05	0.000	0.001	0.002
A3	0.203 REF.			0.008 REF.		
b	0.20	0.28	0.35	0.009	0.011	0.013
D	1.95	2.00	2.05	0.077	0.079	0.081
D2	1.35	1.50	1.65	0.055	0.059	0.063
E	1.95	2.00	2.05	0.077	0.079	0.081
E2	0.75	0.90	1.05	0.031	0.035	0.039
e	0.65 BSC.			0.026 BSC.		
L	0.20	0.30	0.40	0.008	0.012	0.016

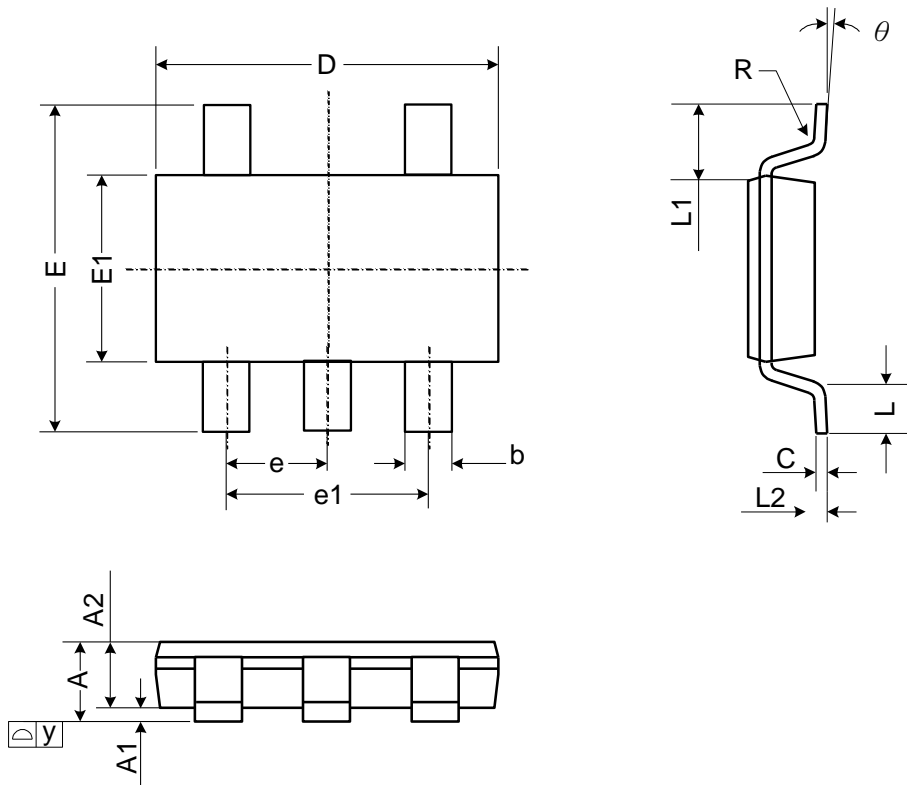
(2) TSOT-23-5L

Symbol	Dimensions in Millimeters			Dimensions in Inches		
	Min.	Nom.	Max.	Min.	Nom.	Max.
A	-	-	1.10	-	-	0.043
A1	0.00	-	0.10	0	-	0.004
A2	0.70	0.90	1.00	0.028	0.035	0.039
b	0.30	0.40	0.50	0.012	0.016	0.020
C	0.08	0.14	0.20	0.003	0.006	0.008
D	2.80	2.90	3.00	0.110	0.114	0.118
E	2.60	2.80	3.00	0.102	0.110	0.118
E1	1.50	1.60	1.70	0.059	0.063	0.067
e	0.95 BSC.			0.037 BSC.		
e1	1.90 BSC.			0.075 BSC.		
L	0.30	0.45	0.60	0.012	0.018	0.024
L1	0.60 REF.			0.024 REF.		
L2	0.25 BSC.			0.010 BSC.		
y	-	-	0.10	-	-	0.004
R	0.10	-	-	0.004	-	-
θ	0°	-	8°	0°	-	8°

JECED outline: MO-193 AB

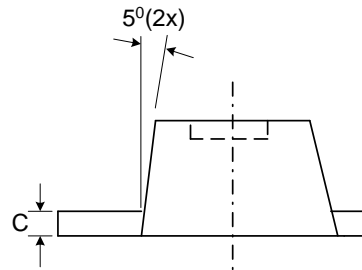
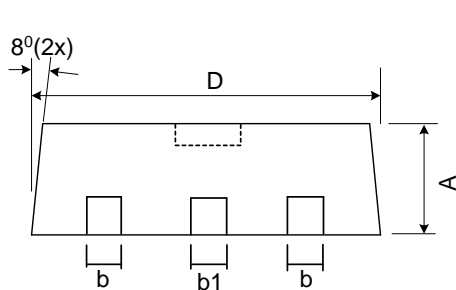
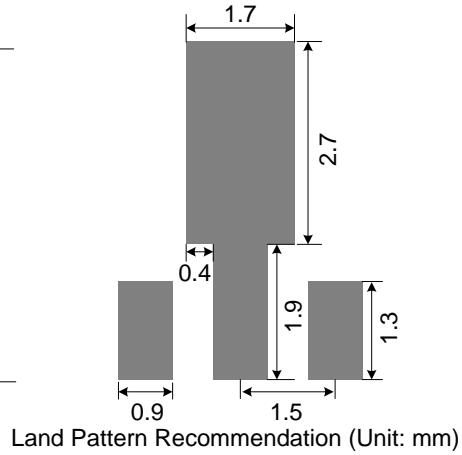
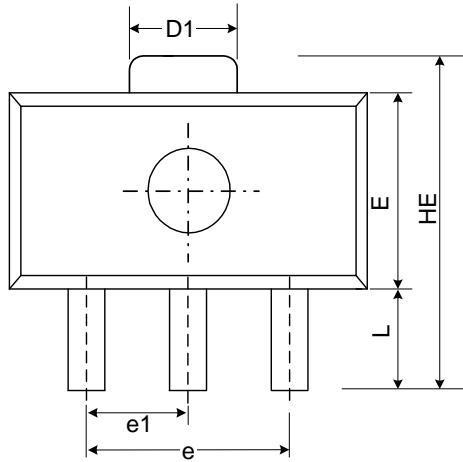
(3) SOT89-3L

Symbol	Dimensions in Millimeters			Dimensions in Inches		
	Min.	Nom.	Max.	Min.	Nom.	Max.
A	1.4	1.5	1.6	0.055	0.059	0.063
b	0.36	0.42	0.48	0.014	0.017	0.019
b1	0.44	0.5	0.56	0.017	0.02	0.022
C	0.35	0.4	0.44	0.014	0.016	0.017
D	4.4	4.5	4.6	0.173	0.177	0.181
D1	1.35	1.59	1.83	0.053	0.063	0.072
e	3.0 BSC			0.118 BSC		
e1	1.5 BSC			0.059 BSC		
E	2.29	2.45	2.6	0.09	0.097	0.102
HE	3.94	4.1	4.25	0.155	0.161	0.167
L	0.8	1	1.2	0.031	0.04	0.047

JEDEC outline: TO-243 AB

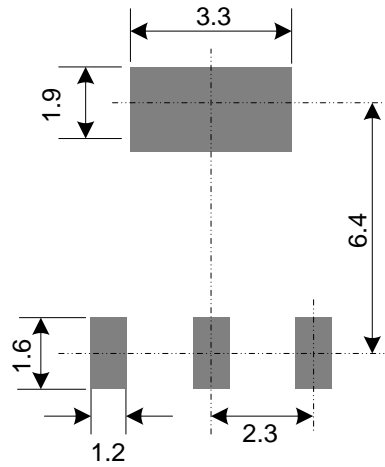
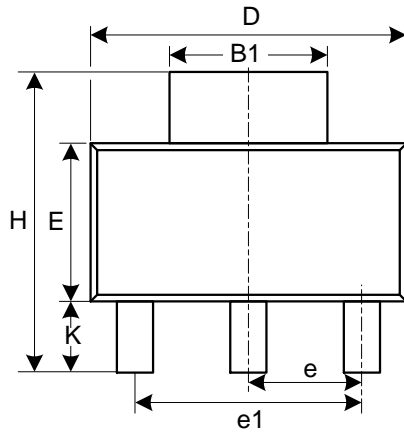
(4) SOT223-3L

Land Pattern Recommendation (Unit: mm)

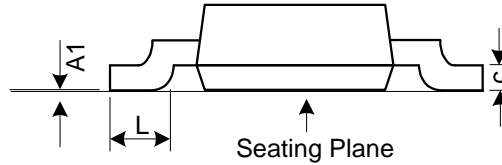
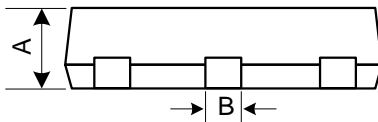

Symbol	Dimensions in Millimeters			Dimensions in Inches		
	Min.	Nom.	Max.	Min.	Nom.	Max.
A	-	-	1.8	-	-	0.071
A1	0.02	0.06	0.1	0.001	0.002	0.004
B	0.66	0.75	0.84	0.026	0.03	0.033
B1	2.9	3	3.1	0.114	0.118	0.122
C	0.23	0.315	0.35	0.009	0.012	0.014
D	6.3	6.5	6.7	0.248	0.256	0.264
E	3.3	3.5	3.7	0.13	0.138	0.146
H	6.7	7	7.3	0.264	0.278	0.287
L	0.75	-	-	0.03	-	-
K	1.5	1.75	2	0.059	0.069	0.079
e	2.3 Basic			0.091 Basic		
e1	4.6 Basic			0.181 Basic		

JEDEC outline: TO-261 AB