

## 2.5W/CH@5V Power Limited Stereo Filter-less Class-D Audio Amplifier with Headphone Driver

### Features

- Supply voltage range: 3.0 V to 5.5 V
- 2.5W power limit function
- 10mA static operation current
- <1uA shutdown current
- 64 step DC volume control from -60dB to +24dB
- Overload and thermal protection
- Loudspeaker Output power @ 1% THD+N
  - 1.4W/CH into 8Ω loudspeaker
  - 2.45W/CH into 4Ω loudspeaker
- Headphone Output power @ 1% THD+N
  - 65mW/CH into 32Ω loudspeaker

### Applications

- Monitor audio
- Portable multimedia devices
- Mobile phone

### Description

The AD52656 is a stereo, filter-less class-D audio amplifier with 2.5W power limit and class-AB headphone driver. Operating with 5.0V power supply, it delivers 2.45W/CH power into 4Ω loudspeaker within 1% THD+N or 65mW/CH power into 32Ω headphone within 1% THD+N

The AD52656 has not only a 64-step DC volume controller, but also a 2.5W power limiter, which implement with an automatic gain controller (AGC).

The AD52656 is packaged as SSOP-24(150mil) is a stereo audio amplifier with high efficiency, which leads to longer battery life, less heat sink, smaller board size, lower system cost, and suitable for the notebook, and portable multimedia devices.

### Ordering Information

Product ID	Package	Packing	Comments
AD52656-ST24NAT	SSOP-24L 150mil	56 Units / Tube 100 Tubes / Small BOX	Green
AD52656-ST24NAR	SSOP-24L 150mil	3K Units/ Reel	Green

### Typical Application Circuit

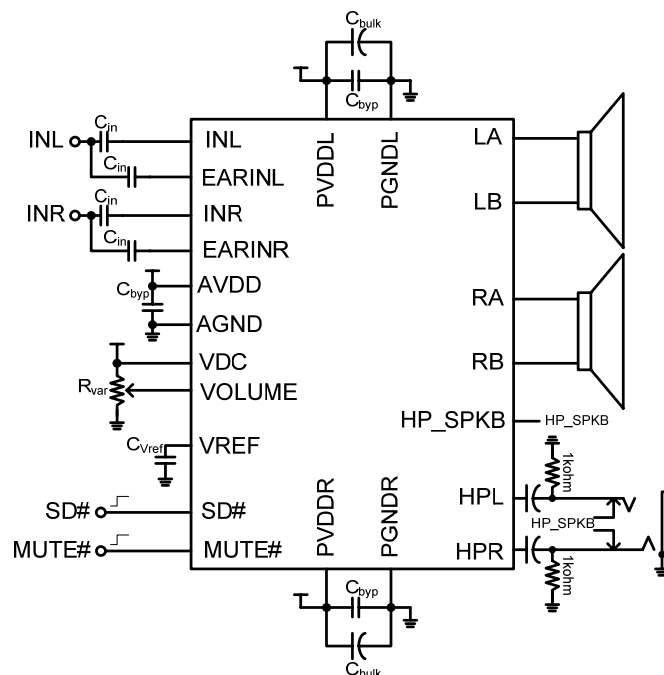

## Pin Assignments

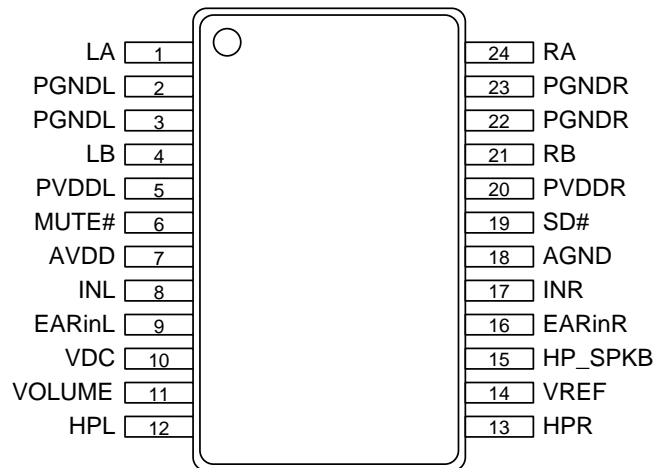

## Pin Description

NAME	TYP	DESCRIPTION	CHARACTERISTIC	
1	LA	O	Speaker driver_Left (+)	
2	PGNDL	G	Power ground_Left	
3	PGNDL	G	Power ground_Left	
4	LB	O	Speaker driver_Left (-)	
5	PVDDL	P	Power supply_Left	
6	MUTE#	I	Mute (low active)	Internal pull-up
7	AVDD	P	Analog power supply	
8	INL	I	Single-ended audio input_Left for SPK	
9	EARinL	I	Single-ended audio input_Left for HP	
10	VDC	I	Full scale level for gain control section	Internal pull-up
11	VOLUME	I	Volume level setting by DC voltage	Internal pull-up
12	HPL	O	Headphone driver_Left	
13	HPR	O	Headphone driver_Right	
14	VREF	I	AVDD/2 reference voltage	
15	HP_SPKB	I.	HP or SPK mode selection (1:HP;0:SPK)	Internal pull-down
16	EARinR	I	Single-ended audio input_Right for HP	
17	INR	I	Single-ended audio input_Right for SPK	
18	AGND	G	Analog power ground	
19	SD#	I	Shutdown (low active)	Internal pull-up
20	PVDDR	P	Power supply_Right	
21	RB	O	Speaker driver_Right (-)	
22	PGNDR	G	Power ground_Right	
23	PGNDR	G	Power ground_Right	
24	RA	O	Speaker driver_Right (+)	

**Functional Block Diagram**

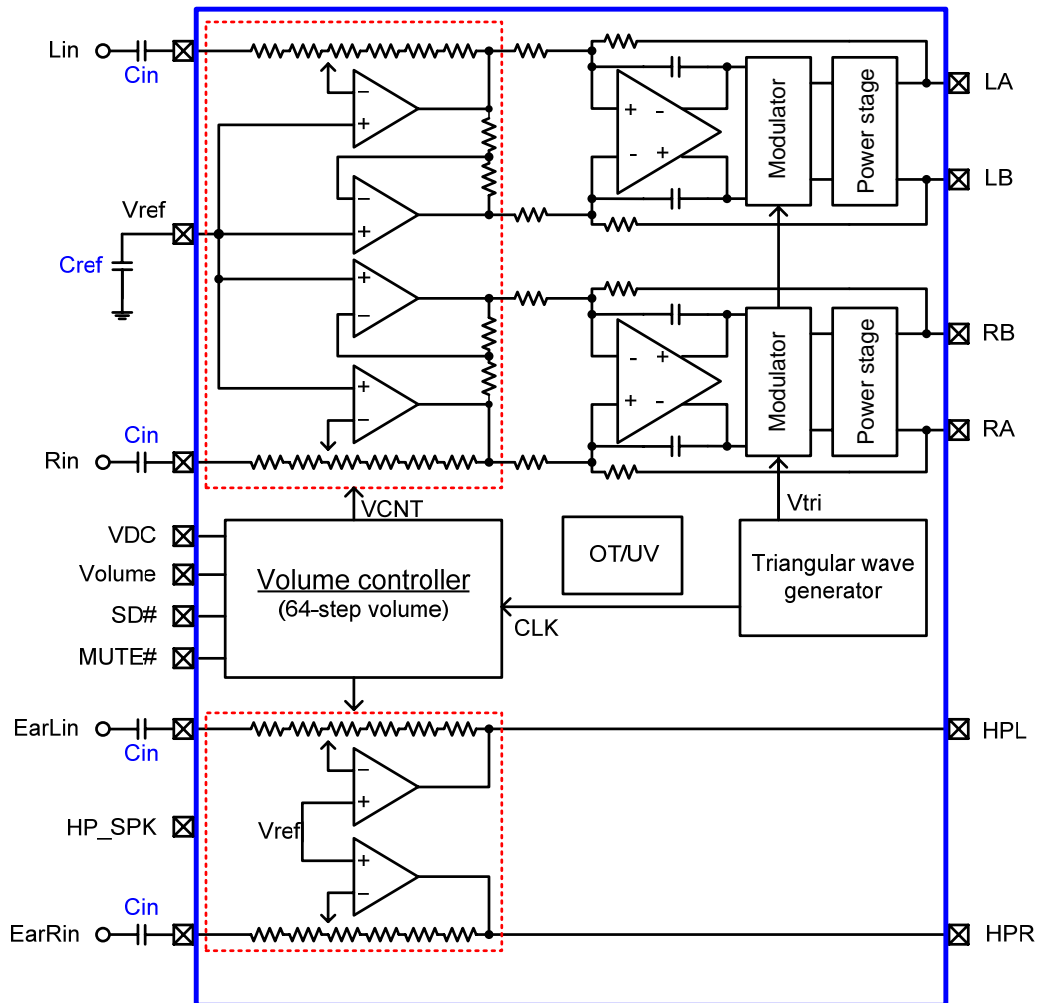

**Available Package**

Package Type	Device No.	$\theta_{ja} (^{\circ}\text{C}/\text{W})$	$\theta_{jc} (^{\circ}\text{C}/\text{W})$
SSOP-24	AD52656	90	17

Note 1:  $\theta_{ja}$  is measured on a room temperature ( $T_A=25^{\circ}\text{C}$ ), natural convection environment test board, which is constructed with a thermally efficient, 2-layers PCB. The measurement is tested using the JEDEC51-3 thermal measurement standard.

Note 2:  $\theta_{jc}$  represents the heat resistance for the heat flow between the chip and the package's top surface.

**Marking Information**

AD52656

Line 1 : LOGO

Line 2 : Product no.

Line 3 : Tracking Code

Line 4 : Date Code

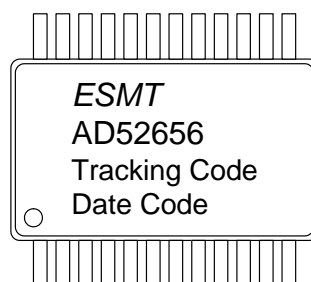

**Absolute Maximum Ratings**

SYMBOL	PARAMETER	MIN	MAX	UNIT
AVDD	Power supply for lower power analog circuits	3.0	6.0	V
PVDDL(R)	Power supply for loudspeaker driver	3.0	6.0	V
	Input voltage	-0.3	AVDD	V
T <sub>stg</sub>	Storage temperature	-65	150	°C
T <sub>j</sub>	Junction temperature	-40	150	°C

**Recommended Operating Conditions**

SYMBOL	PARAMETER	TYP	UNIT
AVDD	Power supply for lower power analog cells	3.0~5.5	V
PVDDL(R)	Power supply for Driver Stage	3.0~5.5	V
V <sub>IH</sub>	High-Level Input Voltage	1.2	V
V <sub>IL</sub>	Low-Level Input Voltage	0.4	V
T <sub>a</sub>	Ambient Operating Temperature	-40~85	°C

**General Electrical Characteristics**

SYMBOL	PARAMETER	CONDITION	MIN	TYP	MAX	UNIT
I <sub>SD</sub>	Supply current during Shut-down mode	AVDD=PVDDR(L)=VDD=5.0V, SD#=0.4V			1	μA
I <sub>Q,SPK</sub>	Supply current during SPEAKER mode	AVDD=PVDDR(L)=VDD=5.0V, SD#=MUTE#=5.0V, HP_SPKB=0V		10	15	mA
I <sub>Q,HP</sub>	Supply current during HEADPHONE mode	AVDD=PVDDR(L)=VDD=5.0V, SD#=MUTE#=HP_SPKB=5.0V		2		mA
I <sub>MUTE, SPK</sub>	Supply current during MUTE mode	AVDD=PVDDR(L)=VDD=5.0V, SD#=5.0V, MUTE#=0.4V, HP_SPKB=0V		2.5	4	mA
I <sub>MUTE, HP</sub>	Supply current during MUTE mode	AVDD=PVDDR(L)=VDD=5.0V, SD#=5.0V, MUTE#=0.4V, HP_SPKB=5.0V		2		mA
V <sub>offset</sub>	Output offset voltage	Input ac grounded		10	50	mV
	Junction temperature for driver shutdown			160		°C
	Temperature hysteresis for recovery from shutdown			125		°C
f <sub>sw</sub>	Switching frequency	AVDD=3.0V~5.0V	200	250	330	kHz
I <sub>SC</sub>	Loudspeaker short-circuit detect resistance	PVDDR(L)=5V		2.2		A

**Electrical Characteristics and Specifications of Loudspeaker Driver**

● AVDD=PVDDL=PVDDR=VDD, Gain= 2V/V, Load=8Ω, f<sub>in</sub>=1 kHz, T<sub>A</sub>=25°C (unless otherwise noted)

SYMBOL	PARAMETER	CONDITION		MIN	TYP	MAX	UNIT
P <sub>O</sub>	RMS Output Power per Channel	VDD=5.0V	THD+N = 1%		1.4		W
		VDD=3.6V	THD+N = 1%		0.7		W
		VDD=3.0V	THD+N = 1%		0.45		W
THD+N	Total Harmonic Distortion plus Noise	VDD=5.0V, P <sub>o</sub> =1.0W			0.1		%
		VDD=3.6V, P <sub>o</sub> =0.5W			0.2		%
		VDD=3.0V, P <sub>o</sub> =0.3W			0.5		%
SNR	Signal to Noise Ratio	VDD=5.0V, P <sub>o</sub> =1.0W			96		dB
PSRR	Power Supply Rejection Ratio	VDD=5.0V, Gain=6dB, V <sub>ripple</sub> =200mVpp, Inputs ac grounded with C <sub>i</sub> =470nF f=1kHz			-55		dB
Crosstalk	Crosstalk	VDD=5.0V, f <sub>in</sub> =1kHz			-100		dB
V <sub>n</sub>	Output integrated noise (A-weighted)	VDD=5.0V f <sub>in</sub> =20Hz ~ 20kHz			80		μV

● AVDD=PVDDL=PVDDR=VDD Gain= 2V/V, Load=4Ω, f<sub>in</sub>=1 kHz, T<sub>A</sub>=25°C (unless otherwise noted)

SYMBOL	PARAMETER	CONDITION		MIN	TYP	MAX	UNIT
P <sub>O</sub>	RMS Output Power per Channel	VDD=5.0V	THD+N = 1%		2.45		W
		VDD=3.6V	THD+N = 1%		1.2		W
		VDD=3.0V	THD+N = 1%		0.8		W
THD+N	Total Harmonic Distortion plus Noise	VDD=5.0V, P <sub>o</sub> =2.0W			0.2		%
		VDD=3.6V, P <sub>o</sub> =1.0W			0.3		%
		VDD=3.0V, P <sub>o</sub> =0.6W			0.6		%
SNR	Signal to Noise Ratio	VDD=5.0V, P <sub>o</sub> =1.8W			96		dB
PSRR	Power Supply Rejection Ratio	VDD=5.0V, Gain=6dB, V <sub>ripple</sub> =200mVpp, Inputs ac grounded with C <sub>i</sub> =470nF f=1kHz			-55		dB
Crosstalk	Crosstalk	VDD=5.0V, f <sub>in</sub> =1kHz			-100		dB
V <sub>n</sub>	Output integrated noise (A-weighted)	VDD=5.0V f <sub>in</sub> =20Hz ~ 20kHz			80		μV

**Typical Characteristics of Loudspeaker Driver**

- Input Signal vs. Output Power (5.0V, +24dB, 8Ω)

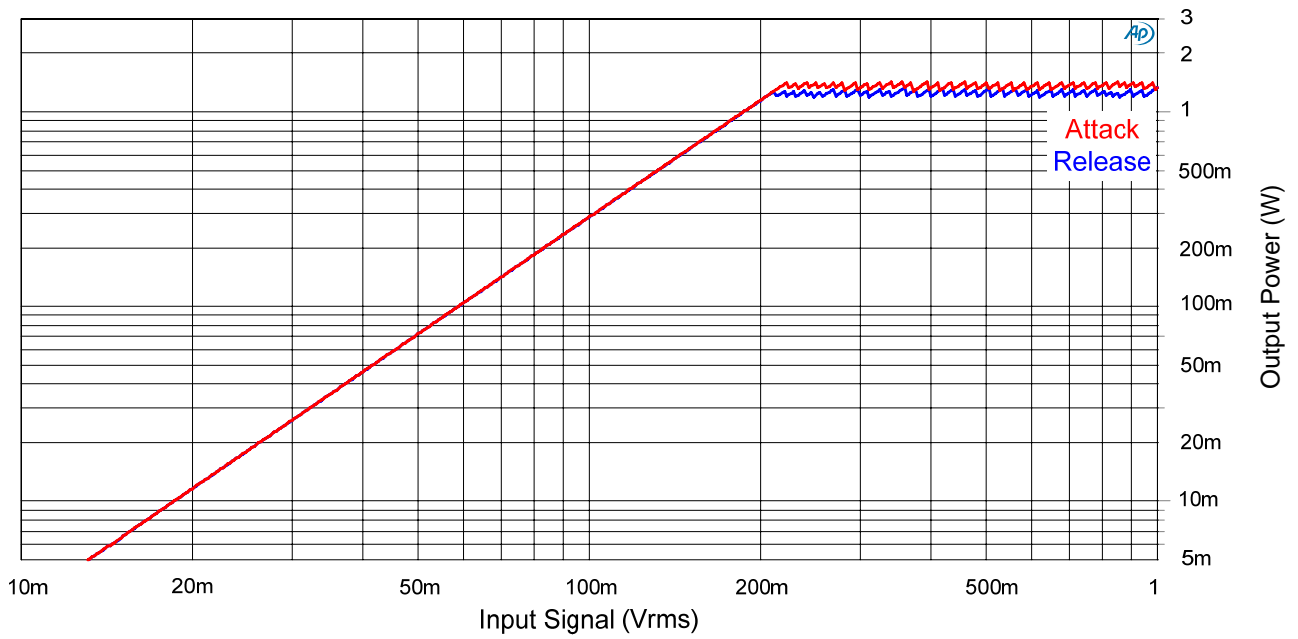

- Input Signal vs. Output Power (3.6V, +24dB, 8Ω)

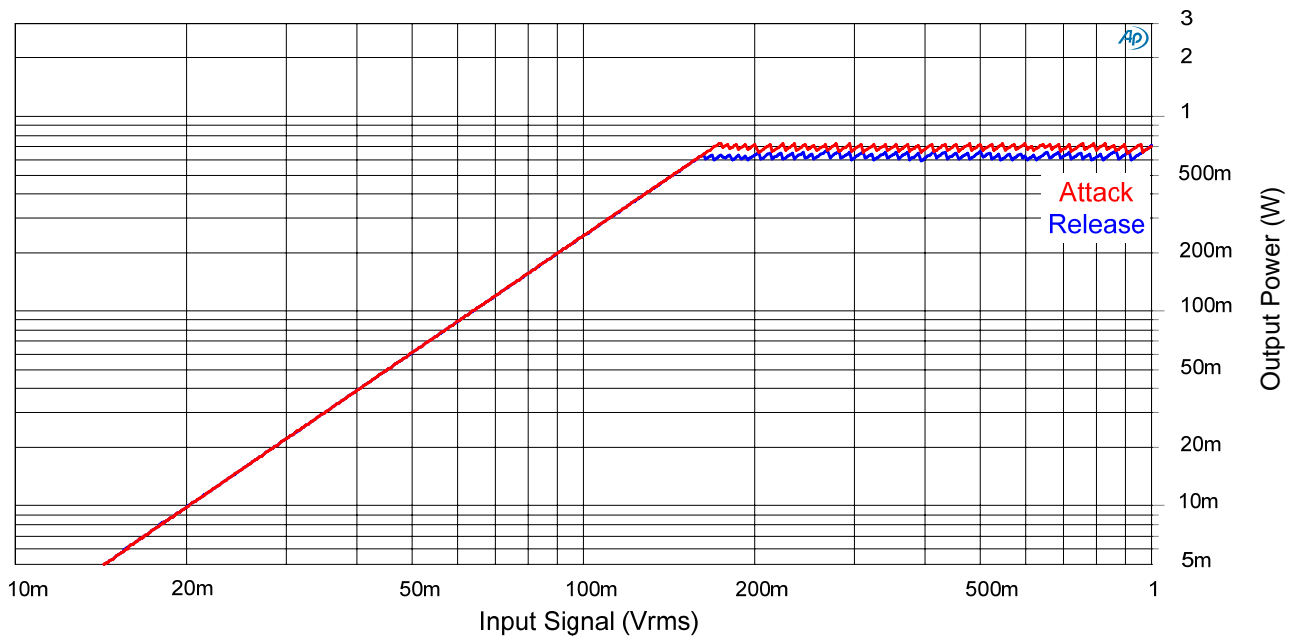

● Input Signal vs. Output Power (3.0V, +24dB, 8Ω)

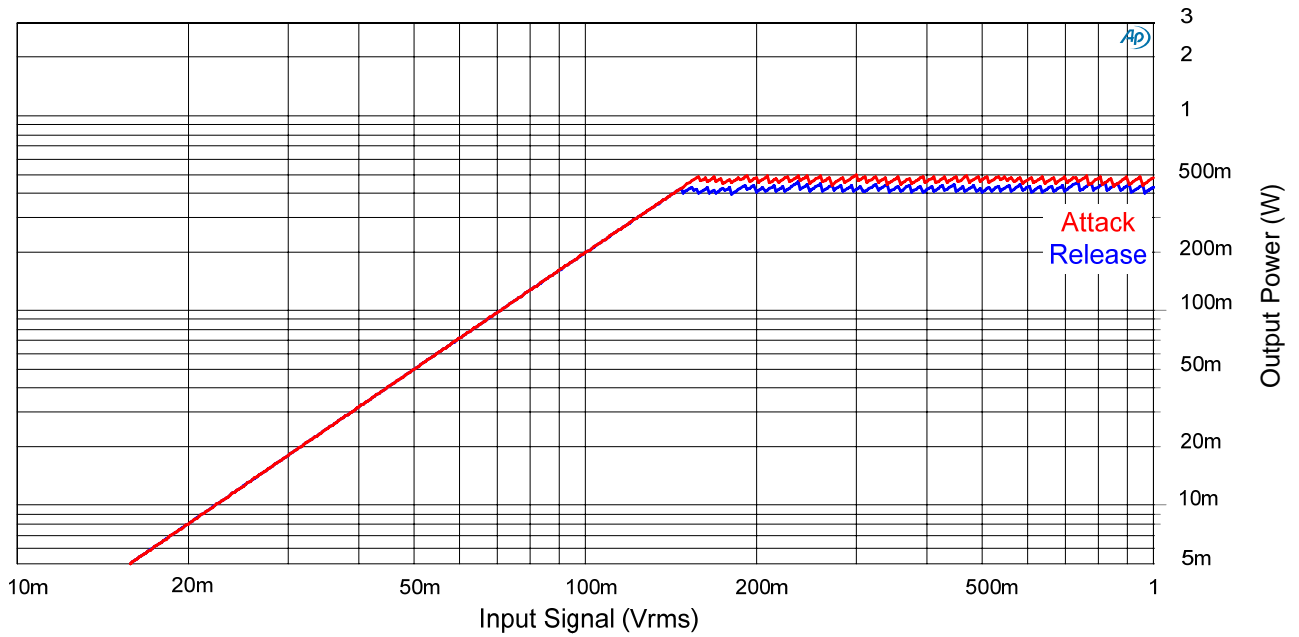

● Input Signal vs. Output Power (5.0V, +24dB, 4Ω)

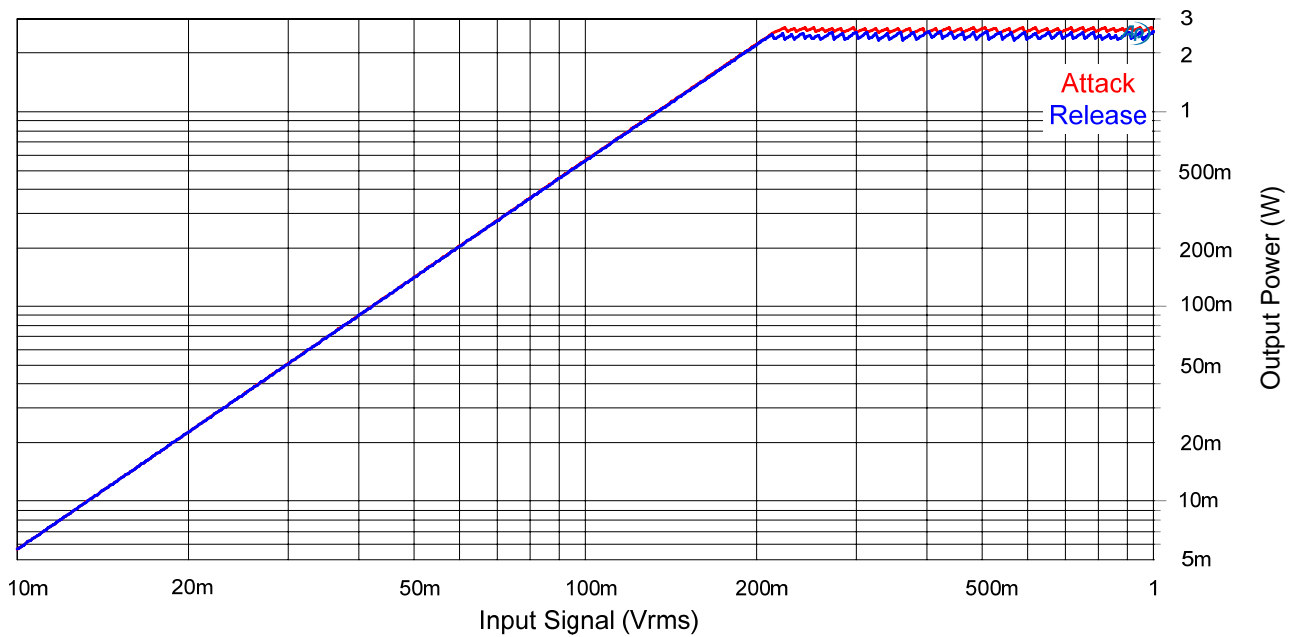

● Input Signal vs. Output Power (3.6V, +24dB, 4Ω)

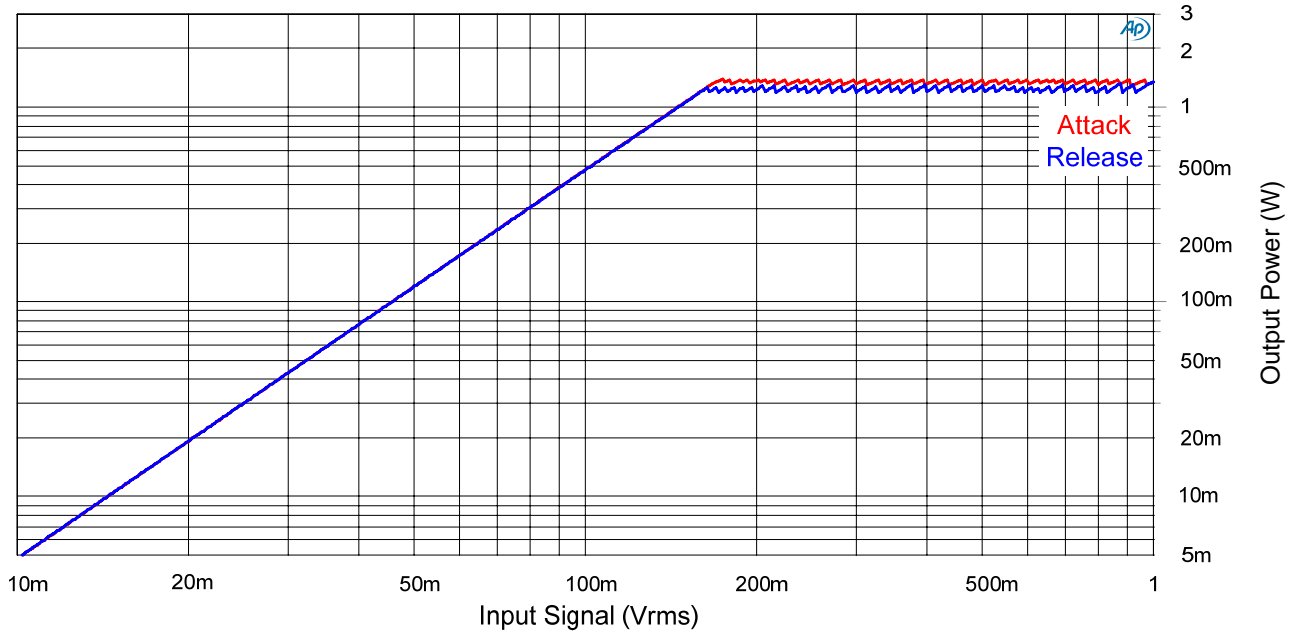

● Input Signal vs. Output Power (3.0V, +24dB, 4Ω)

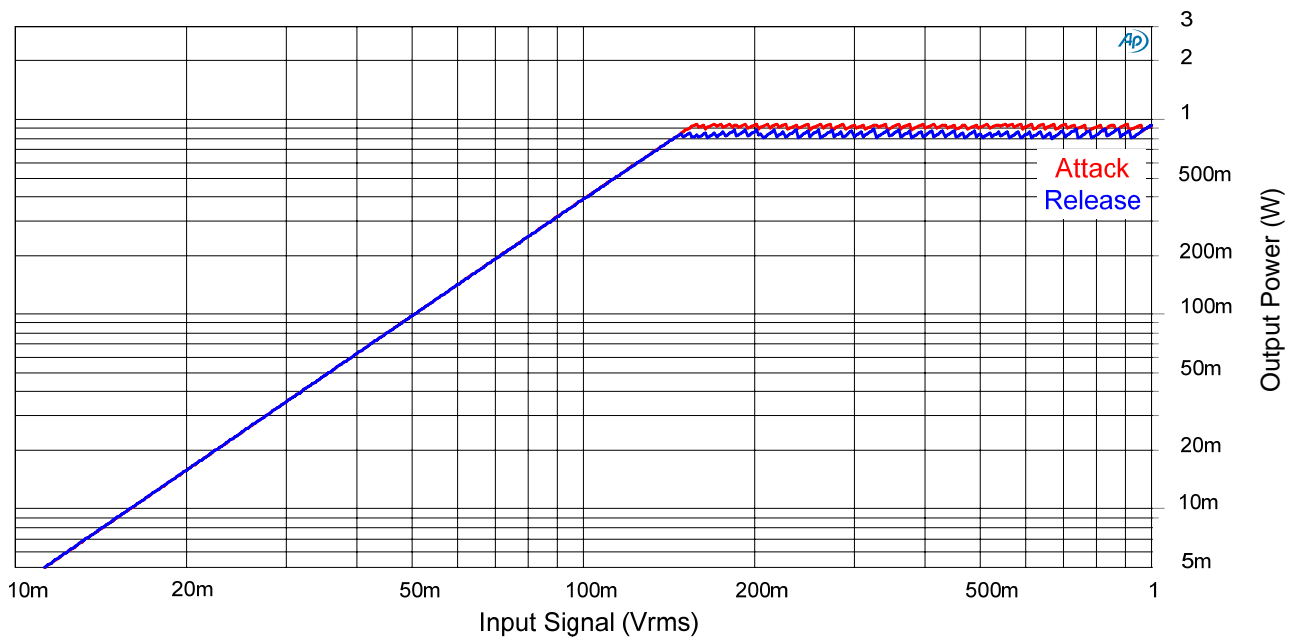



● Total Harmonic Distortion + Noise (THD+N) vs. Signal Frequency (5.0V, 8Ω)

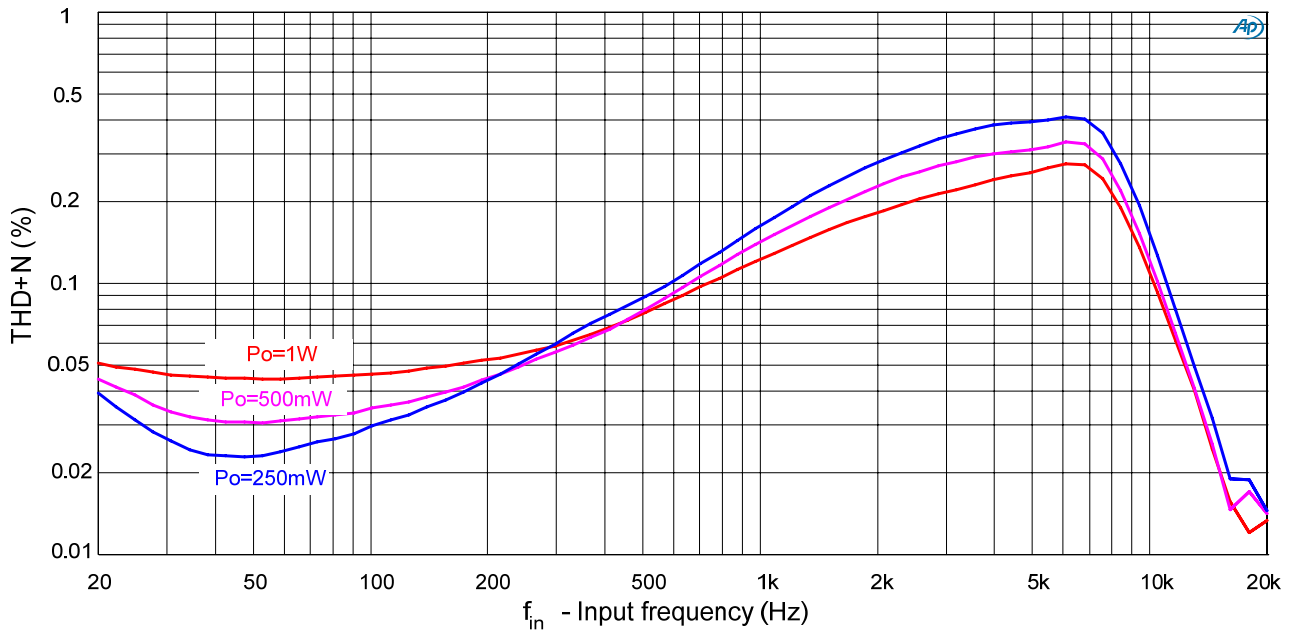

● Total Harmonic Distortion + Noise (THD+N) vs. Signal Frequency (3.6V, 8Ω)

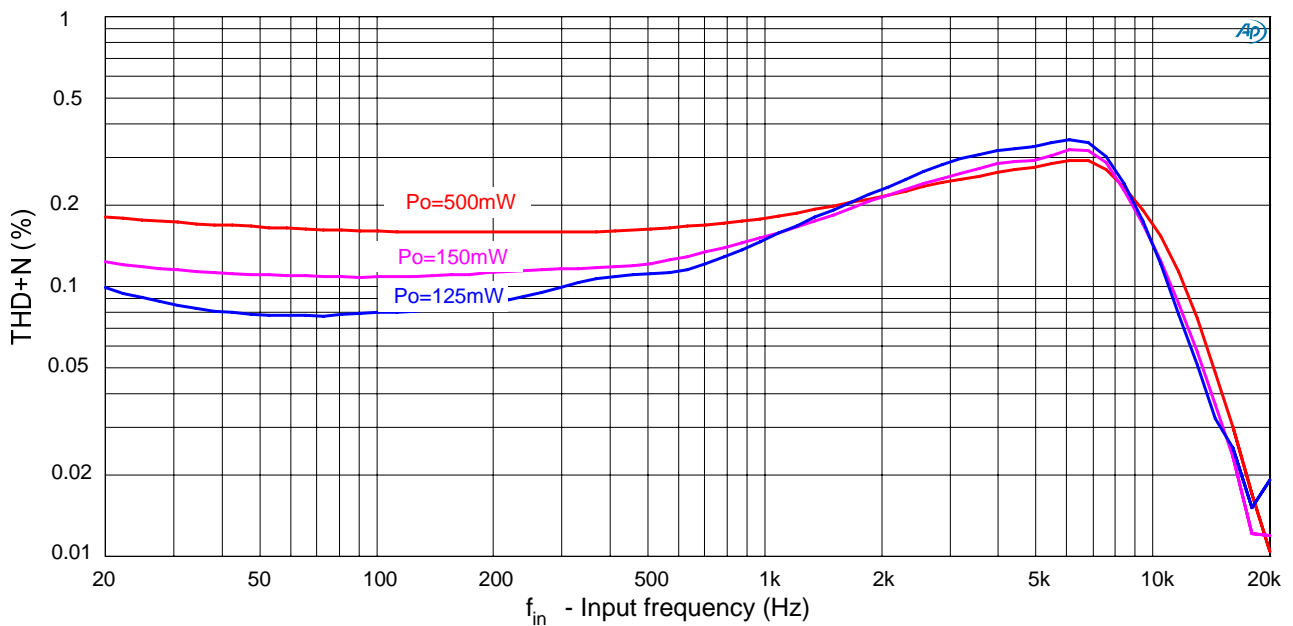

● Total Harmonic Distortion + Noise (THD+N) vs. Signal Frequency (3.0V, 8Ω)

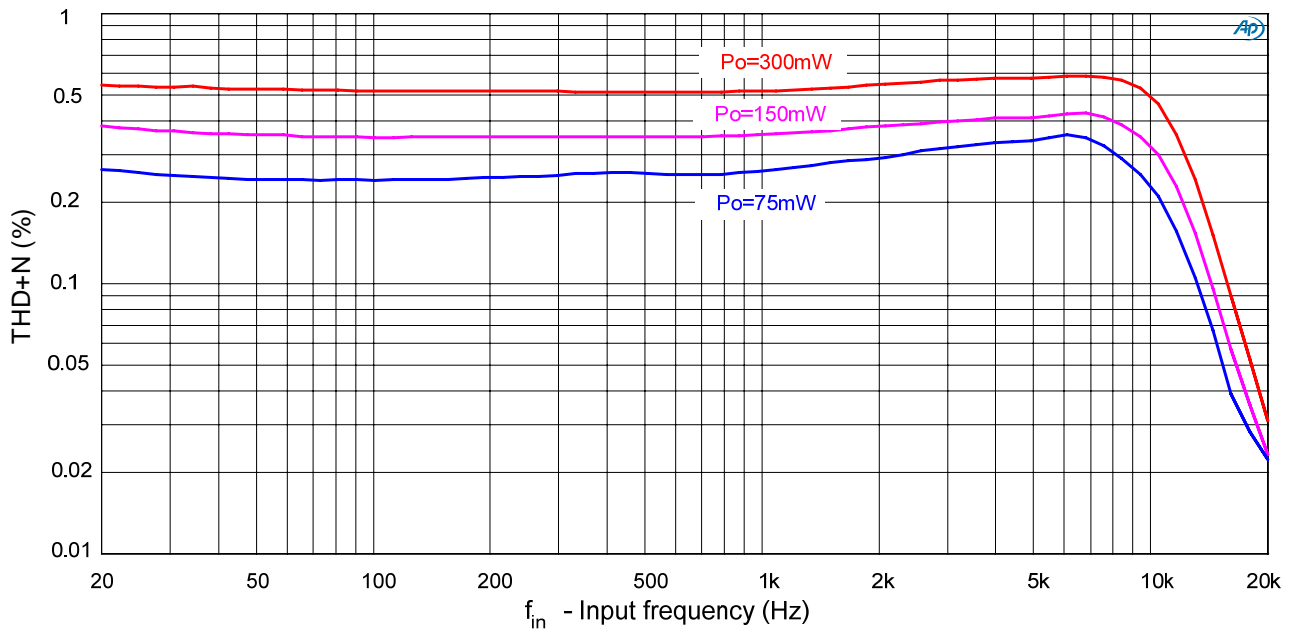

● Total Harmonic Distortion + Noise (THD+N) vs. Signal Frequency (5.0V, 4Ω)

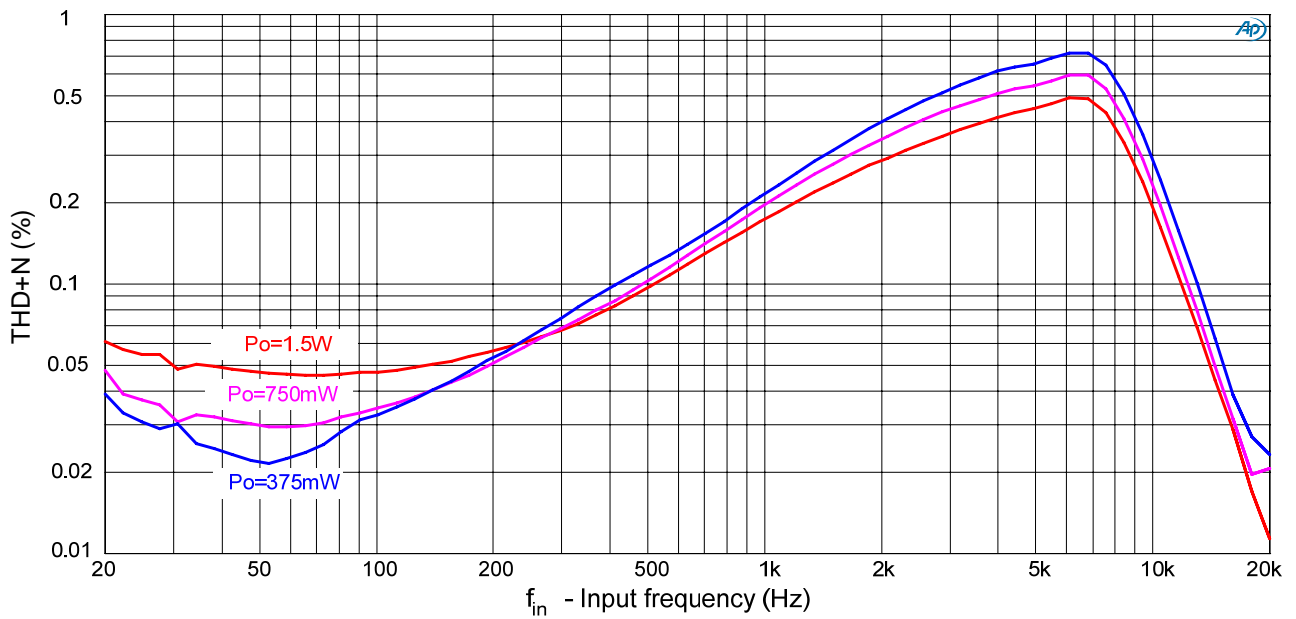

● Total Harmonic Distortion + Noise (THD+N) vs. Signal Frequency (3.6V, 4Ω)

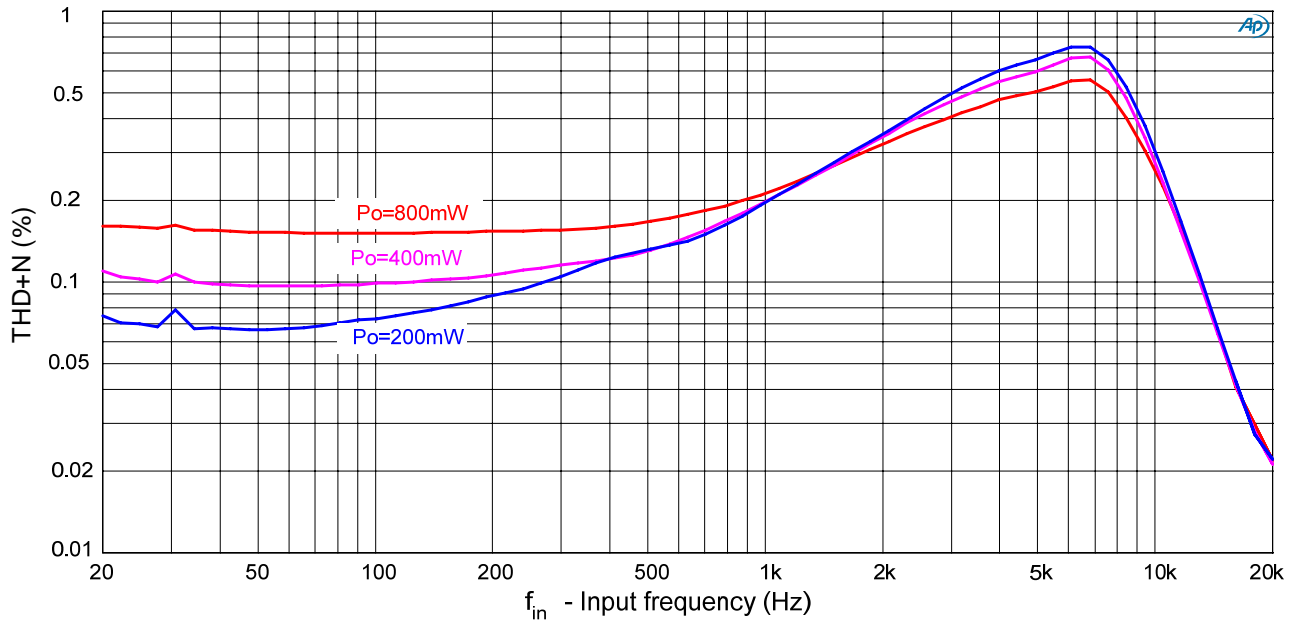

● Total Harmonic Distortion + Noise (THD+N) vs. Signal Frequency (3.0V, 4Ω)

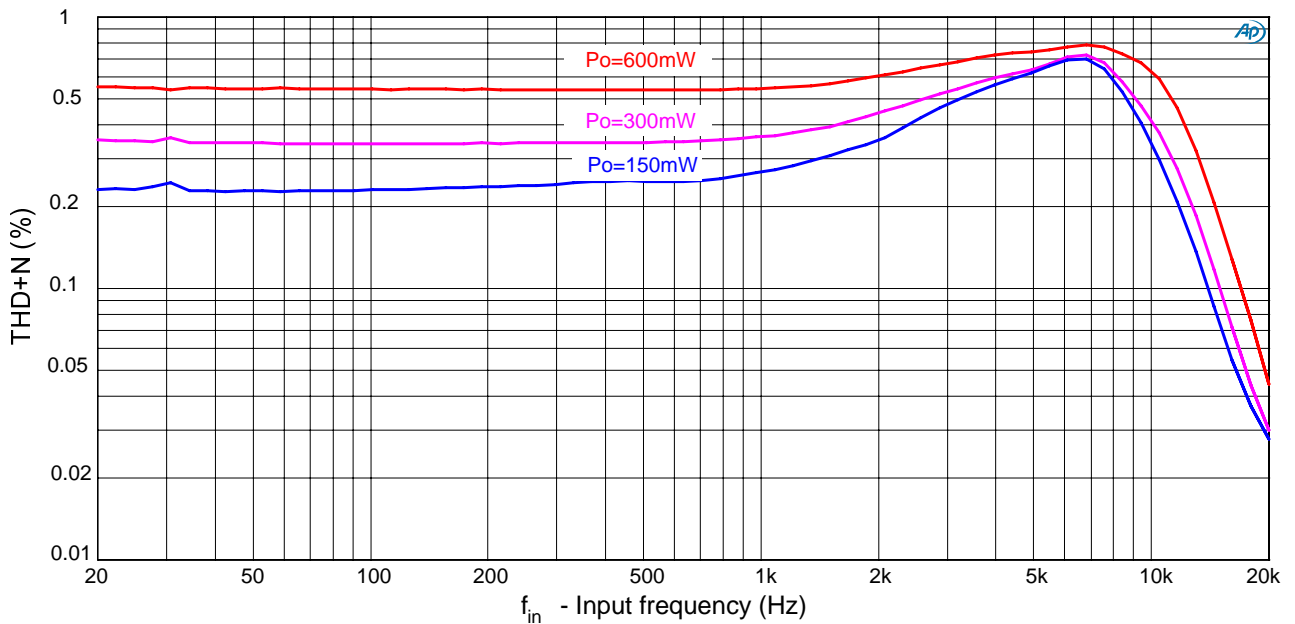

● Power Supply Rejection Ratio vs. Frequency (5V, +6dB)

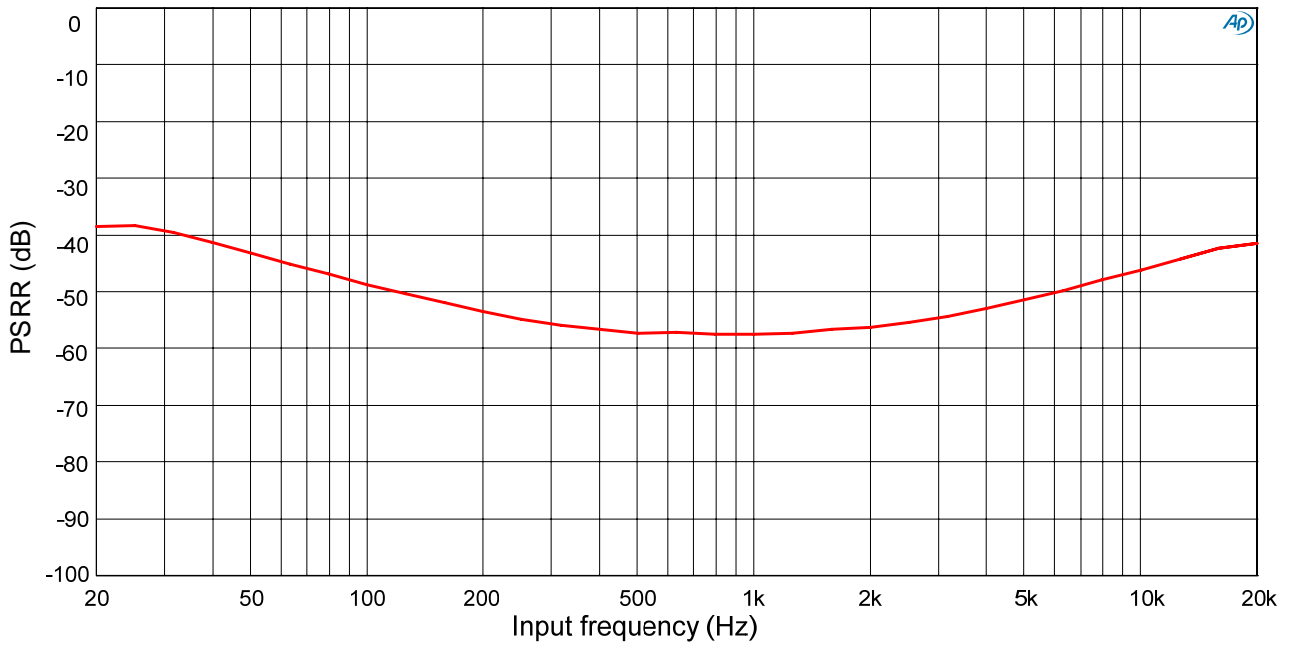

● Efficiency vs. Output Power (8Ω)

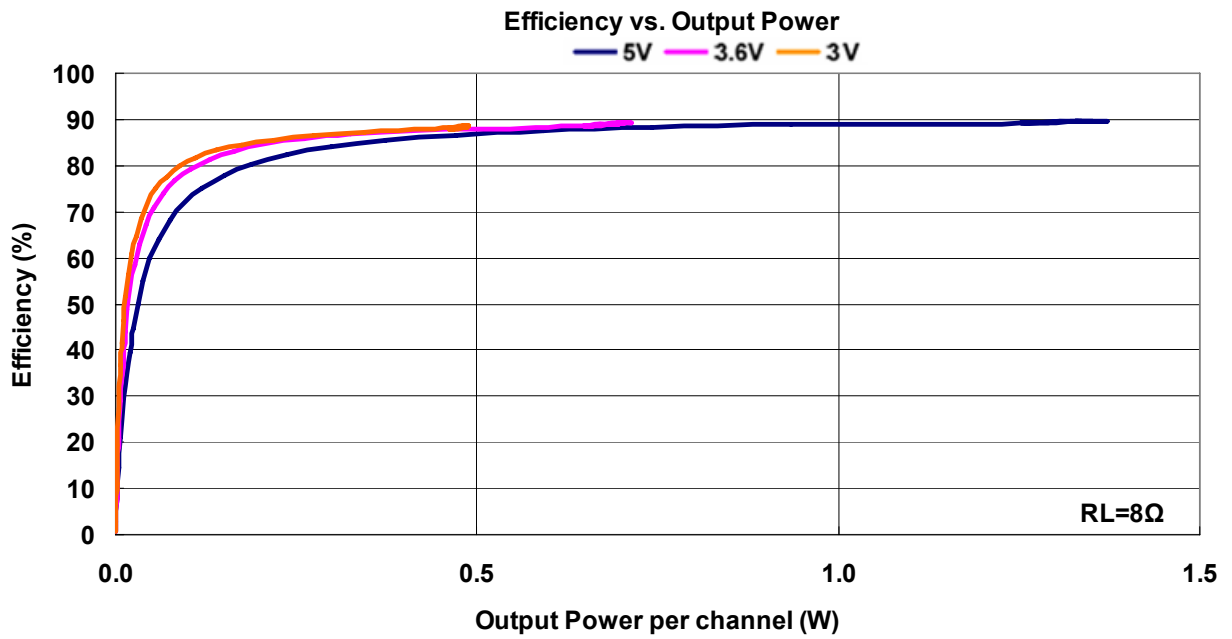

● Efficiency vs. Output Power (4Ω)

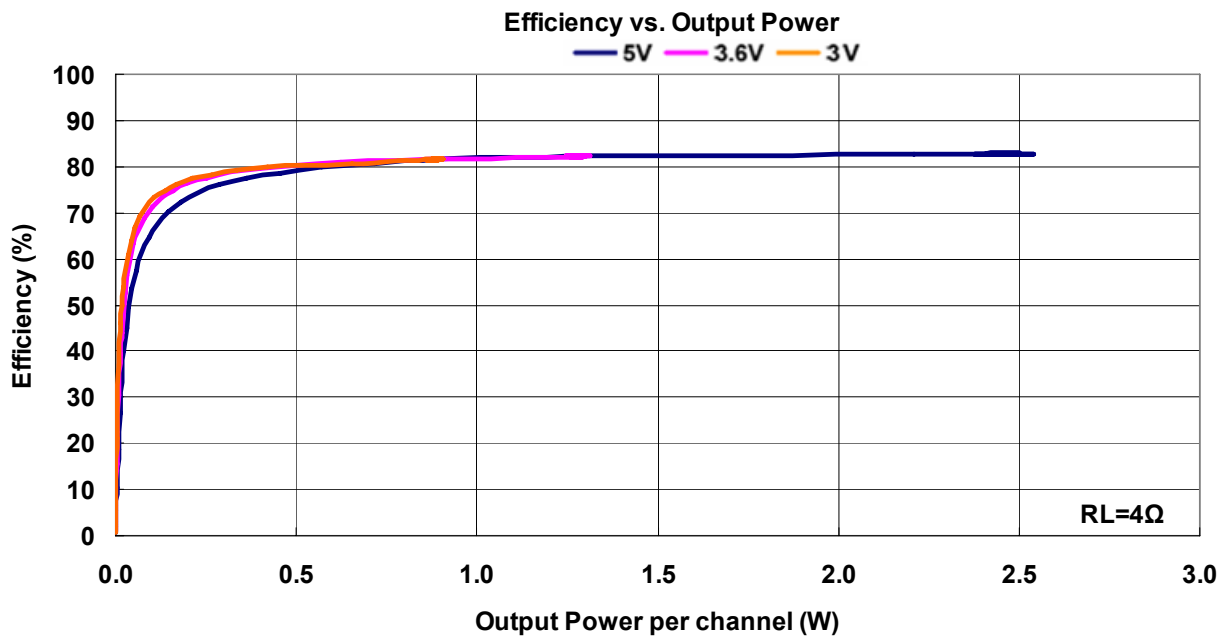

● Power Consumption vs. Output Power (8Ω)

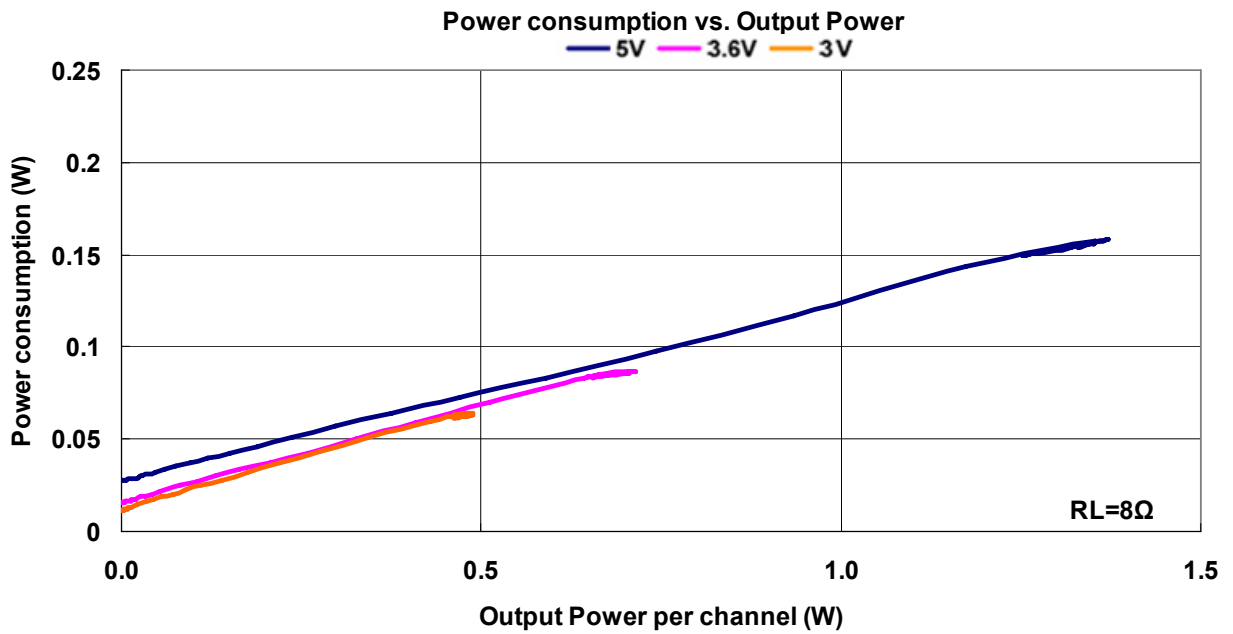

● Power Consumption vs. Output Power (4Ω)

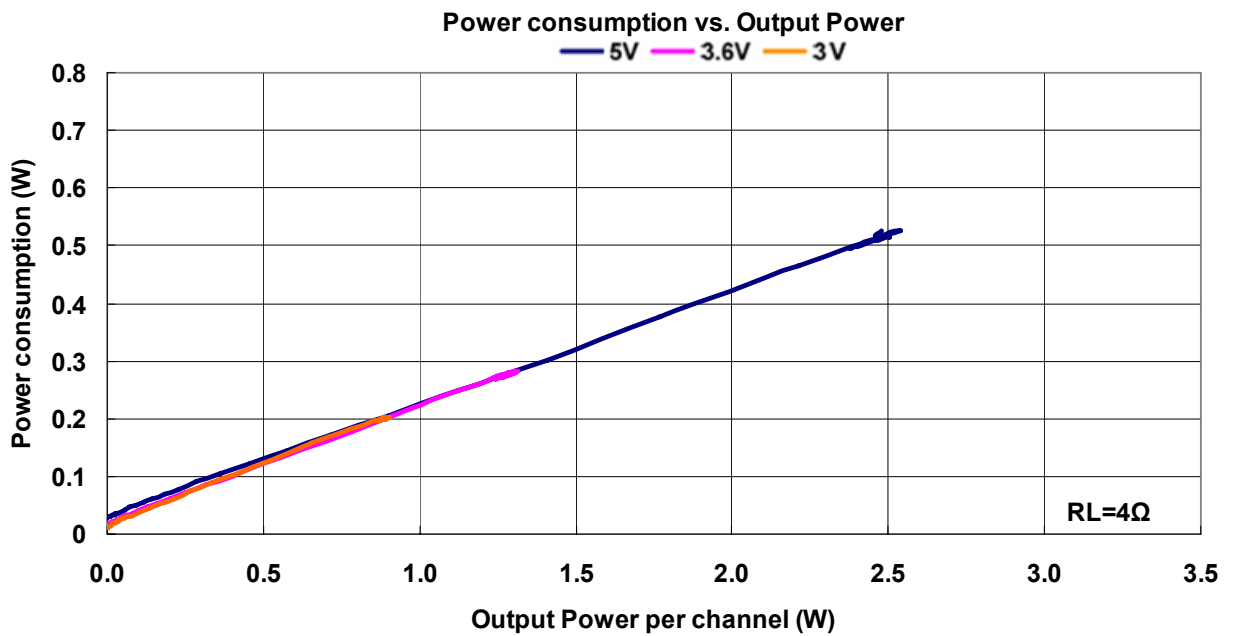

**Electrical Characteristics and Specifications of headphone driver**

- AVDD=PVDDL=PVDDR=VDD, Gain= Max, Load=32Ω,  $f_{in}=1$  kHz,  $T_A=25^\circ\text{C}$  (unless otherwise noted)

SYMBOL	PARAMETER	CONDITION	MIN	TYP	MAX	UNIT	
P <sub>O</sub>	RMS Output Power per Channel	VDD=5.0V	THD+N = 10 %		85		mW
			THD+N = 1 %		65		mW
		VDD=3.6V	THD+N = 10 %		45		mW
			THD+N = 1 %		30		mW
		VDD=3.0V	THD+N = 10 %		30		mW
			THD+N = 1 %		22		mW
THD+N	Total Harmonic Distortion plus Noise	VDD=5.0V, Po=50mW			0.02		%
		VDD=3.6V, Po=25mW			0.02		%
		VDD=3.0V, Po=18mW			0.02		%
SNR	Signal to Noise Ratio	VDD=5.0V, Po=1.8mW			96		dB
PSRR	Power Supply Rejection Ratio	VDD=5.0V, Gain=Max, Ci=0.47uF, Cref=1uF, V <sub>ripple</sub> =200mVpp, inputs ac grounded, f=1kHz			-90		dB
Crosstalk	Crosstalk	VDD=5V, $f_{in}=1$ kHz			-100		dB
V <sub>n</sub>	Output integrated noise (A-weighted)	VDD=5.0V $f_{in}=20\text{Hz} \sim 20\text{kHz}$			40		μV

**Typical Characteristics of of headphone driver**

- Total Harmonic Distortion + Noise (THD+N) vs. Output Power (+3.5dB, 16Ω)

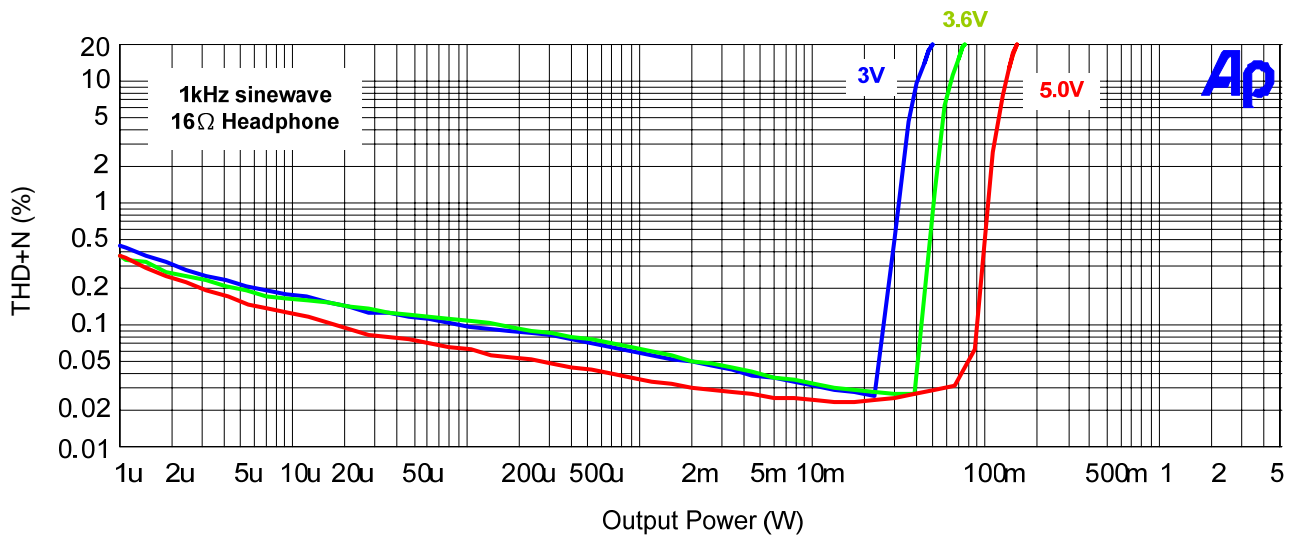

- Total Harmonic Distortion + Noise (THD+N) vs. Output Power (+3.5dB, 32Ω)

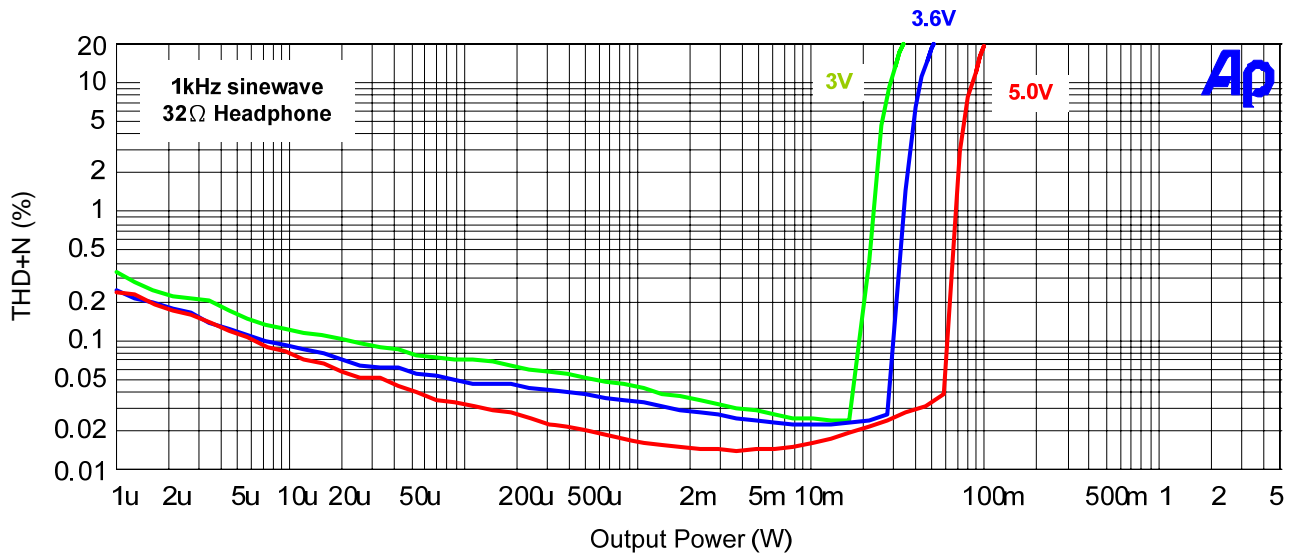



## Operation Descriptions

- Volume control

AD52656 has built-in a 64-steps DC volume controller, and the volume level is set by the VOLUME DC voltage to VDC ratio. To avoid volume level oscillation from one to adjacent one, the hysteresis voltage between the nearby volume levels is designed in AD52656. For example, the volume level changes from LEVEL14 to LEVEL15 when DC voltage applied on VOLUME increases to  $25.0 - (25.0 - 21.8) / 4 = 24.2(\%)$  of VDC. And, the volume level drops from LEVEL15 to LEVEL14 when DC voltage applied on VOLUME decreases to  $20.4 + (23.6 - 20.4) / 4 = 21.2(\%)$  of VDC. More volume levels, gains, and its DC voltage ratio applied on VOLUME are listed in following table.

Level	SPK Gain(dB)	HP Gain(dB)	Volume (% of VDC)	Level	SPK Gain(dB)	HP Gain(dB)	Volume (% of VDC)	Level	SPK Gain(dB)	HP Gain(dB)	Volume (% of VDC)
0	-60	-94.6	0.0 ~ 4.2	22	7.8	-16.3	31.6 ~ 34.6	43	16.1	-3.3	61.0 ~ 63.8
1	-40	-56.0	1.9 ~ 5.6	23	8.1	-15.7	33.0 ~ 36.0	44	16.5	-2.8	62.4 ~ 65.2
2	-34	-50.2	3.8 ~ 7.0	24	8.5	-15.0	34.4 ~ 37.4	45	16.9	-2.3	63.8 ~ 66.6
3	-28	-40.7	5.2 ~ 8.4	25	8.9	-14.2	35.8 ~ 38.8	46	17.3	-1.8	65.2 ~ 68.0
4	-22	-36.8	6.6 ~ 9.8	26	9.3	-13.4	37.2 ~ 40.2	47	17.7	-1.4	66.6 ~ 69.4
5	-16	-34.2	8.0 ~ 11.2	27	9.7	-12.6	38.6 ~ 41.6	48	18.1	-0.9	68.0 ~ 70.8
6	-10	-32.1	9.4 ~ 12.4	28	10.1	-11.8	40.0 ~ 43.0	49	18.5	-0.5	69.4 ~ 72.2
7	-7.5	-30.4	10.8 ~ 13.8	29	10.5	-11.1	41.4 ~ 44.4	50	18.9	0.0	70.8 ~ 73.6
8	-4.9	-28.1	12.2 ~ 15.2	30	10.9	-10.5	42.8 ~ 45.8	51	19.3	0.5	72.2 ~ 75.0
9	-2.4	-27.0	13.6 ~ 16.6	31	11.3	-9.8	44.2 ~ 47.2	52	19.7	0.9	73.6 ~ 76.4
10	0.1	-25.9	15.0 ~ 18.0	32	11.7	-9.2	45.6 ~ 48.6	53	20.1	1.2	75.0 ~ 77.8
11	1.6	-24.8	16.2 ~ 19.4	33	12.1	-8.6	47.0 ~ 50.0	54	20.5	1.5	76.4 ~ 79.2
12	3.2	-23.8	17.6 ~ 20.8	34	12.5	-8.0	48.4 ~ 51.4	55	20.9	1.8	77.8 ~ 80.6
13	4.1	-22.9	19.0 ~ 22.2	35	12.9	-7.4	49.8 ~ 52.8	56	21.3	2.1	79.2 ~ 82.0
14	4.6	-22.1	20.4 ~ 23.6	36	13.3	-6.8	51.2 ~ 54.2	57	21.7	2.5	80.6 ~ 83.4
15	5	-21.4	21.8 ~ 25.0	37	13.7	-6.3	52.6 ~ 55.6	58	22.1	2.8	82.2 ~ 84.8
16	5.4	-20.6	23.2 ~ 26.4	38	14.1	-5.8	54.0 ~ 57.0	59	22.5	3.1	83.6 ~ 86.2
17	5.8	-20.0	24.6 ~ 27.8	39	14.5	-5.2	55.4 ~ 58.4	60	22.9	3.2	85.0 ~ 87.6
18	6.2	-19.3	26.0 ~ 29.2	40	14.9	-4.7	56.8 ~ 59.8	61	23.3	3.4	86.4 ~ 89.0
19	6.6	-18.5	27.4 ~ 30.6	41	15.3	-4.2	58.2 ~ 61.2	62	23.7	3.6	87.8 ~ 90.2
20	7	-17.7	28.8 ~ 31.8	42	15.7	-3.7	59.6 ~ 62.4	63	24	3.8	> 90.2
21	7.4	-17.0	30.2 ~ 33.2								

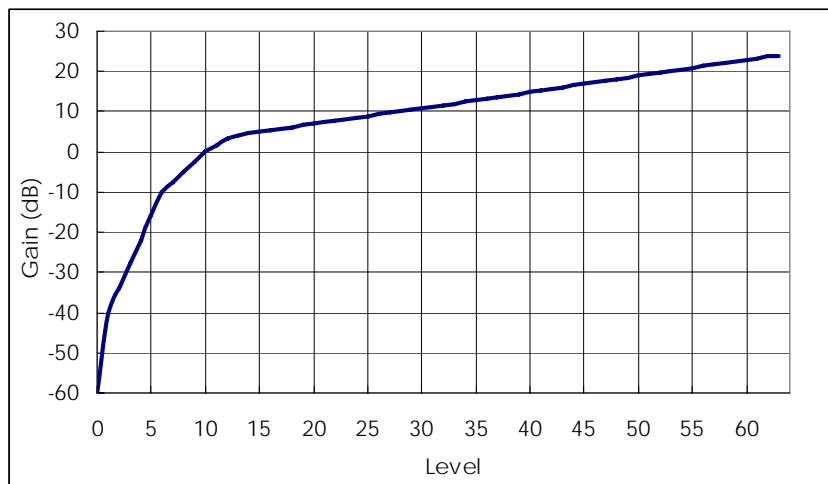

- Power limit

The power limit circuit built-in AD52656 is used to keep the power amplifier performs high quality audio into speakers and to prevent the speakers from damage when higher volume level is selected.

- Self-protection circuits (typical values are used below.)

AD52656 has built-in over-temperature, overload and voltage detectors.

(i) If the internal junction temperature is higher than 160°C, the outputs of loudspeaker drivers will be disabled and at low state. The temperature hysteresis for AD52656 to return to normal operation is about 35°C. The variation of protected temperature is around 10%.

(ii) AD52656 has built-in overload protection for both right and left channel. To protect loudspeaker drivers from over-current damage when the wires of loudspeaker are shorted to one another, GND or VDD, circuits for the detection of output loading are built in the AD52656. For normal operation, loudspeaker resistance is larger than 3.2Ω is required. Otherwise, overload detectors may activate. Once one of right and left channel is overloaded, both loudspeaker drivers will be disabled. And, AD52656 will be recovery from overload fault by toggling SD# down to low and back to high after removing the short.

- Shut-down control (SD#)

During shutdown mode, means SD#=0, AD52656 ceases all internal circuits To avoid annoying pop during power on/off, well SD# control, like with a power ready signal, is suggested. And, due to its internal pull-up, there is no pop if let the SD# floating.

- Mute control (MUTE#)

Like SD# mode, AD52656 ceases output driver, but keep part of internal circuit still working. That could provide quick disable and enable power amplifier.

- Headphone and speaker switching

The AD52656 is a stereo class-D audio amplifier with stereo class-AB headphone driver. By setting HP\_SPKB pin, AD52656 can switch between loudspeaker and headphone mode. When HP\_SPKB pin is pulled high, AD52656 is in headphone mode and loudspeaker drivers are off. When HP\_SPKB is low, AD52656 is in loudspeaker mode and headphone drivers are off. There is an internal pull-down design on HP\_SPKB pin. With the internal pull-down design, mode switching between headphone and loudspeaker will be automatic when headphone is plugged in or pulled out the headphone jack.

**Application information**

● **Input capacitors ( $C_{in}$ )**

The performance at low frequency (bass) is affected by the corner frequency ( $f_c$ ) of the high-pass filter composed of input resistors ( $R_{in}$ ) and input capacitors ( $C_{in}$ ), determined in equation (a). And, the resistance of input resistors is different at different volume gain. But there is 20% variation in input resistance from 20% process variation in actual resistance of the input resistors. Typically, a 0.47 $\mu$ F or 1 $\mu$ F ceramic capacitor is suggested.

$$f_c = \frac{1}{2\pi R_{in} C_{in}} \text{ (Hz)} \dots\dots\dots (a)$$

Loudspeaker	
Gain (dB)	Rin (ohm)
24	42k
18	73k
12	115k
6	160k

Headphone	
Gain (dB)	Rin (ohm)
3.5	65k
-6	108k
-12	128k
-18	144k

● **Capacitor on Vref ( $C_{Vref}$ )**

In order to reduce low-frequency noise produced by power supply, the capacitor ( $C_{Vref}$ ) on Vref, which is the mid-rail voltage of AVDD, is necessary. It is also good for PSRR. And, to have less annoying pop, the recommended  $C_{Vref}$  is the same with  $C_{in}$ .

● **Decoupling capacitor ( $C_{byp}$  and  $C_{bulk}$ )**

Because of the power loss on the trace, which is between the device and decoupling capacitor, the decoupling capacitor should be placed as close to the device PVDDL (PVDDR) and PGNDL (PGNDR) to reduce any parasitic resistor or inductor between them. And, a low ESR ceramic capacitor ( $C_{byp}$ ), typically 1 $\mu$ F, is suggested for high frequency transients and as close to AD52656 as possible. For filtering audio band noise signal, a 10 $\mu$ F or greater capacitor ( $C_{bulk}$ ) (tantalum or electrolytic type) is suggested.

● **Headphone DC decoupling capacitors ( $C_{hp}$ )**

The DC decoupling capacitors ( $C_{hp}$ ) between headphone and HPL/HPR pins are used to remove the DC voltage on the headphone from HPL/HPR. The high pass filter, which is composed of the headphone resistance and the DC decoupling capacitor, attenuates the low frequency audio performance. For 16 $\Omega$  headphone, the electrolytic or tantalum capacitor with 100 $\mu$ F or greater is suggested. The relationship between  $f_{hc}$ ,  $R_{hp}$  and  $C_{hp}$  is shown in the below equation (b).

$$f_{hc} = \frac{1}{2\pi R_{hp} C_{hp}} \text{ (Hz)} \dots\dots\dots (b)$$

**Package Dimensions**

- SSOP 24 (150mil)

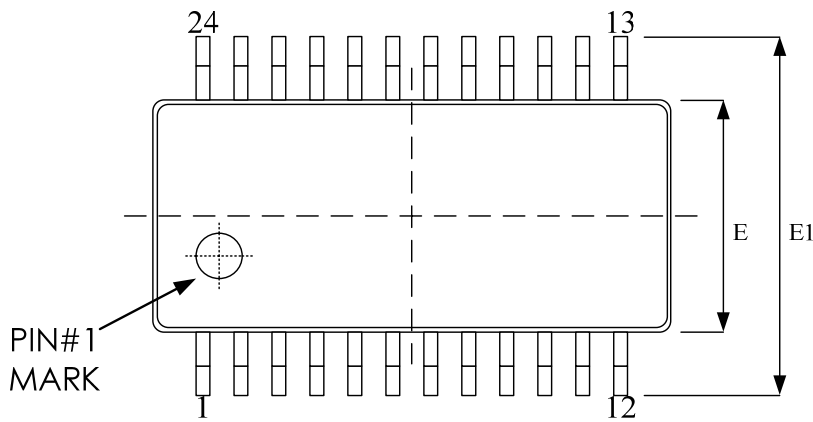

**TOP VIEW**

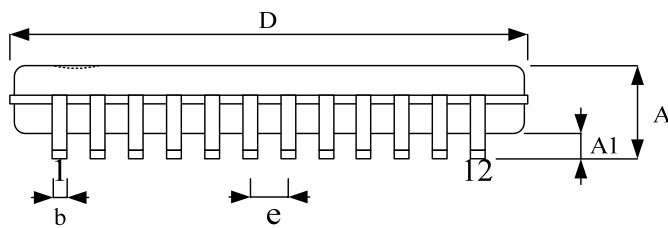
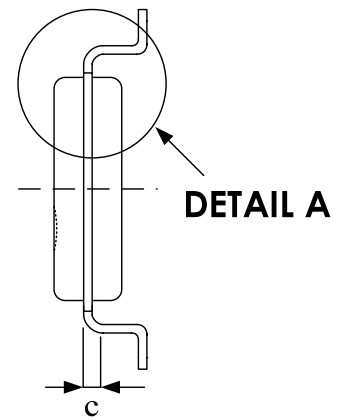

**SIDE VIEW**

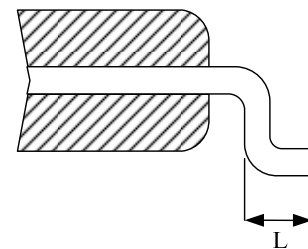

**DETAIL A**

Symbol	Dimension in mm	
	Min	Max
A	1.35	1.75
A1	0.10	0.25
b	0.20	0.31
c	0.18	0.25
D	8.53	8.74
E	3.80	4.00
E1	5.80	6.20
e	0.635 BSC	
L	0.38	1.27

**Revision History**

<b>Revision</b>	<b>Date</b>	<b>Description</b>
0.1	2014.07.22	Original
1.0	2015.04.01	1. Modify package dimensions 2. Remove preliminary word and modify version to 1.0
1.1	2015.04.15	Add ordering packing information
1.2	2015.05.19	1. Change operating voltage from 3.0~5.0V to 3.0~5.5V. 2. Change AMR voltage from 5.5V to 6.0V
1.3	2016.02.05	1. Replace $T_a$ (Ambient Operating Temperature) by $T_j$ (Junction temperature) in Absolute Maximum Ratings. 2. Change Ambient operating temperature from 0~70°C to -40~85°C. 3. Modify the Description and Volume Table of Volume Control

**Important Notice**

All rights reserved.

No part of this document may be reproduced or duplicated in any form or by any means without the prior permission of ESMT.

The contents contained in this document are believed to be accurate at the time of publication. ESMT assumes no responsibility for any error in this document, and reserves the right to change the products or specification in this document without notice.

The information contained herein is presented only as a guide or examples for the application of our products. No responsibility is assumed by ESMT for any infringement of patents, copyrights, or other intellectual property rights of third parties which may result from its use. No license, either express, implied or otherwise, is granted under any patents, copyrights or other intellectual property rights of ESMT or others.

Any semiconductor devices may have inherently a certain rate of failure. To minimize risks associated with customer's application, adequate design and operating safeguards against injury, damage, or loss from such failure, should be provided by the customer when making application designs.

ESMT's products are not authorized for use in critical applications such as, but not limited to, life support devices or system, where failure or abnormal operation may directly affect human lives or cause physical injury or property damage. If products described here are to be used for such kinds of application, purchaser must do its own quality assurance testing appropriate to such applications.