

1.5MHz 600mA, Synchronous Step-Down Regulator

General Description

EML9366 is designed with high efficiency step down DC/DC converter for portable devices applications. It features with extreme low quiescent current with no load which is the best fit for extending battery life during the standby mode. The device operates from 2.5V to 5.5V input voltage and up to 600mA output current capability. High 1.5MHz internal frequency makes small surface mount inductors and capacitors possible and reduces overall PCB board space. Further, build-in synchronous switch makes external Schottky diode is no longer needed and efficiency is improved. EML9366 is designed base on pulse width modulation (PWM) for low output voltage ripple and fixed frequency noise, low dropout mode provides 100% duty cycle operation. Low reference voltage is designed for achieving regulated output down to 0.6V. The device is available in an adjustable version and fixed output voltages of 1.2V, 1.5V, 1.8V and 3.3V. The EML9366 is available in SOT package.

Features

- Achieve 95% efficiency
- Input Voltage : 2.5V to 5.5V
- Output Current up to 600mA
- Reference voltage 0.6V
- Quiescent Current 200 μ A with No Load
- Internal switching frequency 1.5MHz
- No Schottky Diode needed
- Low Dropout Operation: 100% Duty Cycle
- Shutdown current < 1 μ A
- Excellent Line and Load Transient Response
- Over-temperature Protection

Applications

- Blue-Tooth devices
- Cellular and Smart Phones
- Personal multi-media Player (PMP)
- Wireless networking
- Digital Still Cameras
- Portable applications

Typical Application (adjustable)

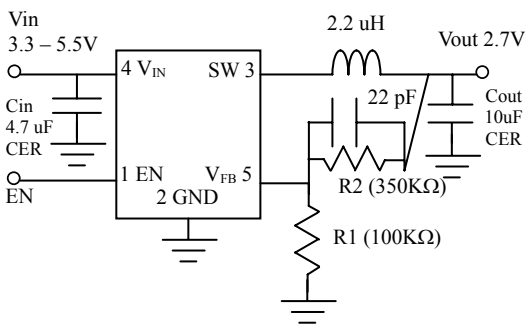

Fig. 1

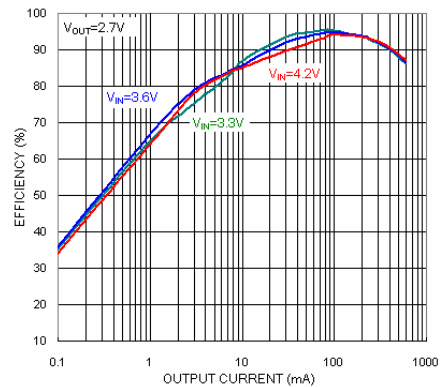
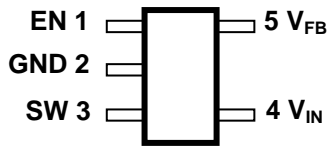

Fig. 2

CONNECTION DIAGRAM

SOT-23-5



ORDER INFORMATION

EML9366-XXVF05GRR/NRR
 XX Output voltage
 VF05 SOT-23-5Package
 GRR RoHS (Pb Free)
 Rating: -40 to 85°C
 Package in Tape & Reel
 NRR RoHS & Halogen free (By Request)
 Rating: -40 to 85°C
 Package in Tape & Reel

Package	Vout	Product ID	Marking	Packing
SOT-23-5	1.2	EML9366-12VF05GRR		Tape & Reel 3Kpcs
	1.8	EML9366-18VF05GRR		
	3.3	EML9366-33VF05GRR		
SOT-23-5	adjustable	EML9366-00VF05GRR		

Package configuration

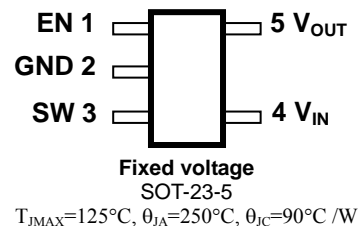
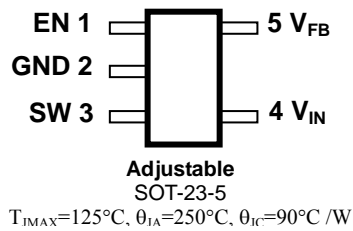

Pin Functions

Pin #	Pin Name	Function
1	EN	Enable Pin. Minimum 1.2V to enable the device. Maximum 0.4V to shut down the device. Do not leave this pin floating and enable the chip after V_{IN} is in the input voltage range.
2	GND	Ground Pin.
3	SW	Switch Pin. Must be connected to Inductor. This pin connects to the drains of the internal main and synchronous power MOSFET switches.
4	V_{IN}	Input voltage Pin. Must be closely decoupled to GND pin with a 4.7 μF or greater ceramic capacitor.
5	V_{FB} (Adjustable)	Feedback Pin. Receives the feedback voltage from an external resistive divider across the output.
	V_{OUT} (Fixed voltage)	Output Voltage Pin. An internal resistive divider divides the output voltage down for comparison to the internal reference voltage.

Absolute Maximum Ratings

Devices are subjected to failure if they stay above absolute maximum ratings.

Input Voltage ----- -0.3V to 6V
 EN, V_{FB} Voltages ----- -0.3V to V_{IN}
 SW Voltage ----- -0.3V to (V_{IN} + 0.3V)
 PMOS Switch Source Current (DC) ----- 800mA
 NMOS Switch Sink Current (DC) ----- 800mA
 Peak Switch Sink and Source Current ----- 1.3A

Operating Temperature Range ----- -40°C to 85°C
 Junction Temperature (Notes 1, 3) ----- 125°C
 Storage Temperature Range ----- -65°C to 150°C
 Lead Temperature (Soldering, 10 sec) ----- 240°C
 ESD Susceptibility HBM ----- 2KV
 MM ----- 200V

Electrical Characteristics

The ● denotes specifications which apply over the full operating temperature range, otherwise specifications are T_A = 25°C. V_{IN} = 3.6V unless otherwise specified.

Symbol	Parameter	Conditions	Min	Typ	Max	Units
I _{VFB}	Feedback Current				±30	nA
V _{FB}	Regulated Feedback Voltage	T _A = 25°C	0.588	0.600	0.612	V
ΔV _{FB}	Reference Voltage Line Regulation	V _{IN} = 2.5V to 5.5V ●			0.4	%/V
V _{OUT} %	Output Voltage Accuracy		-3		3	%
ΔV _{OVL}	Output Over-voltage Lockout	ΔV _{OVL} = V _{OVL} - V _{FB} , EML9366	20	50	80	mV
		ΔV _{OVL} = V _{OVL} - V _{OUT} , EML9366-Fixed	2.5	7.8	13	%
ΔV _{OUT}	Output Voltage Line Regulation	V _{IN} = 2.5V to 5.5V ●			0.4	%/V
I _{PK}	Peak Inductor Current	V _{IN} = 3V, V _{FB} = 0.5V or V _{OUT} = 90%, Duty Cycle < 35%		1.0		A
V _{LOADREG}	Output Voltage Load Regulation			0.5		%
I _S	Quiescent Current (Note 2)	V _{FB} = 0.5V or V _{OUT} = 90%		200	340	μA
	Shutdown	V _{EN} = 0V, V _{IN} = 4.2V		0.1	1	μA
f _{OSC}	Oscillator Frequency	V _{FB} = 0.6V or V _{OUT} = 100% ●	1.2	1.5	1.8	MHz
		V _{FB} = 0V or V _{OUT} = 0V ●		290		kHz
R _{PFET}	R _{DS(ON)} of PMOS	I _{SW} = 100mA		0.45	0.55	Ω
R _{NFET}	R _{DS(ON)} of NMOS	I _{SW} = -100mA		0.40	0.5	Ω
I _{LSW}	SW Leakage	V _{EN} = 0V, V _{SW} = 0V or 5V, V _{IN} = 5V			±1	μA
V _{EN}	Enable Threshold	●	1.2			V
	Shutdown Threshold	●			0.4	V
I _{EN}	EN Leakage Current	●			±1	μA

Note 1: T_J is a function of the ambient temperature T_A and power dissipation P_D (T_J = T_A + (P_D)(250°C/W))

Note 2: Dynamic quiescent current is higher due to the gate charge being delivered at the switching frequency.

Note 3: This IC is build-in over-temperature protection to avoid damage from overload conditions.

Typical Performance Characteristics

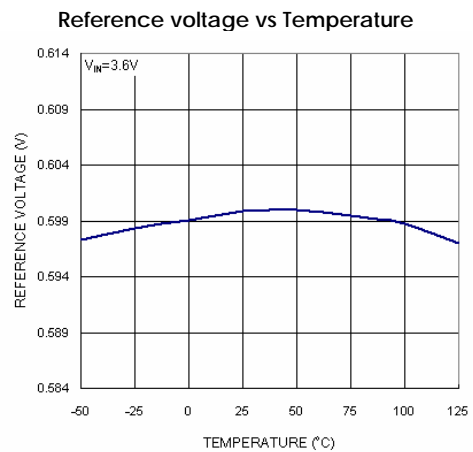
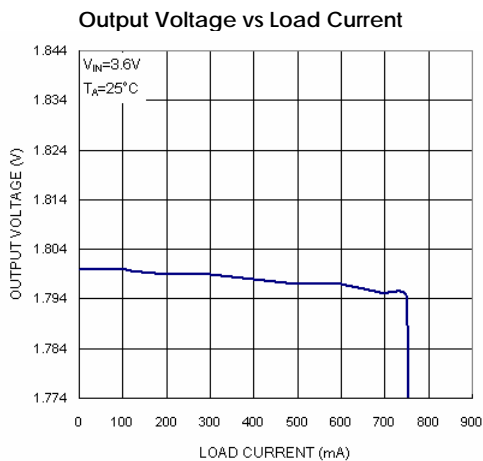
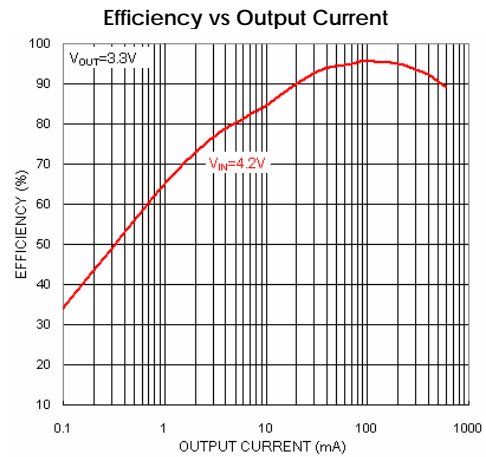
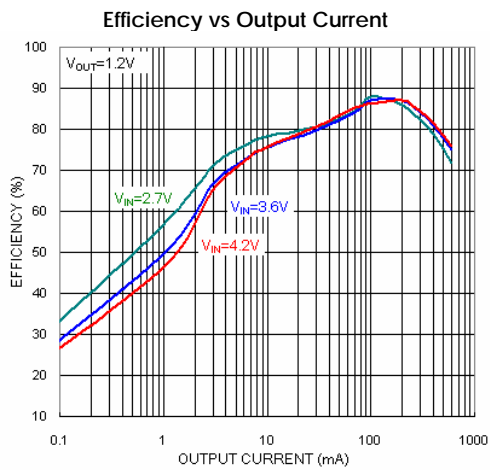
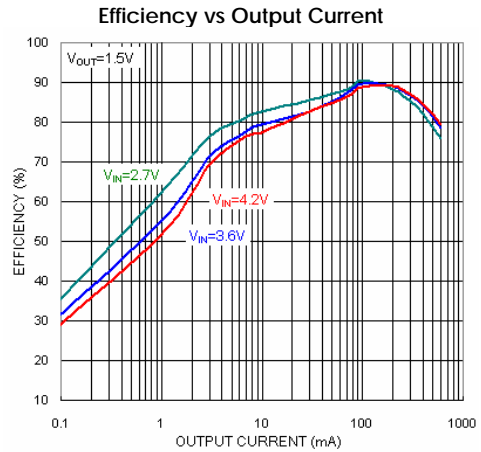
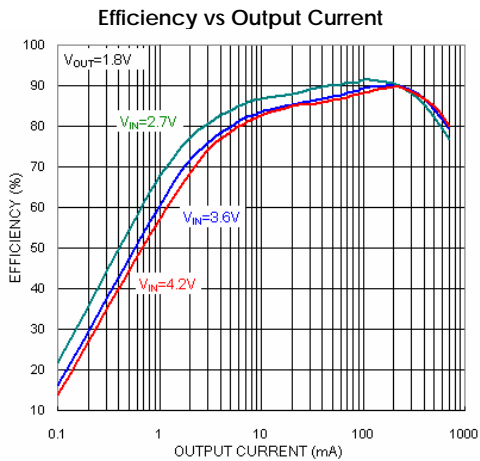

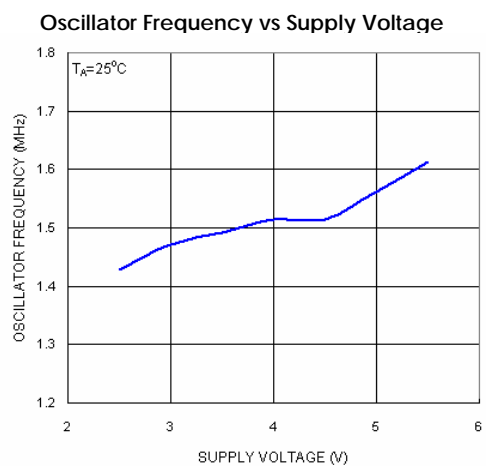
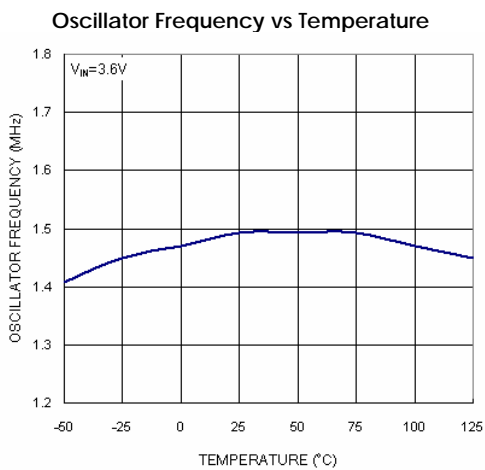
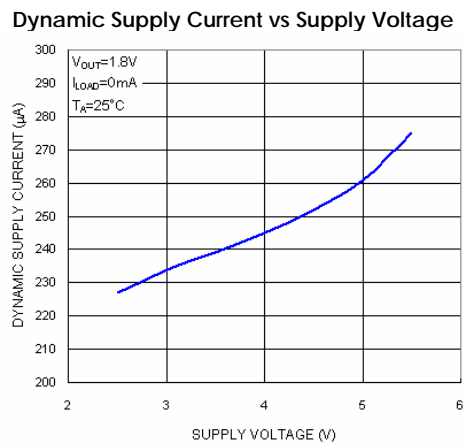
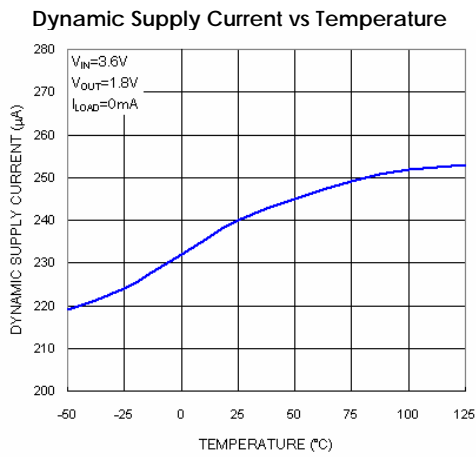
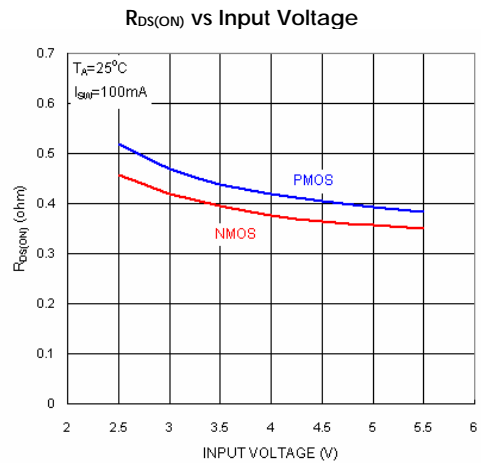
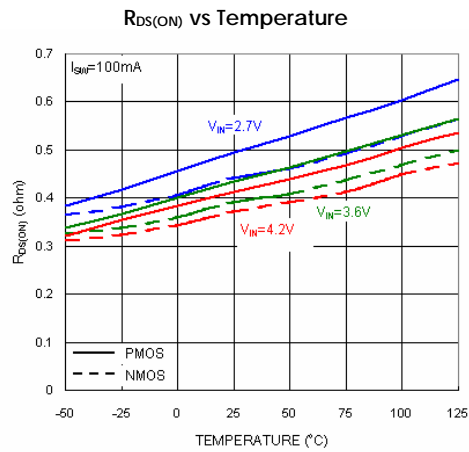

Typical Performance Characteristics

Discontinuous Operation

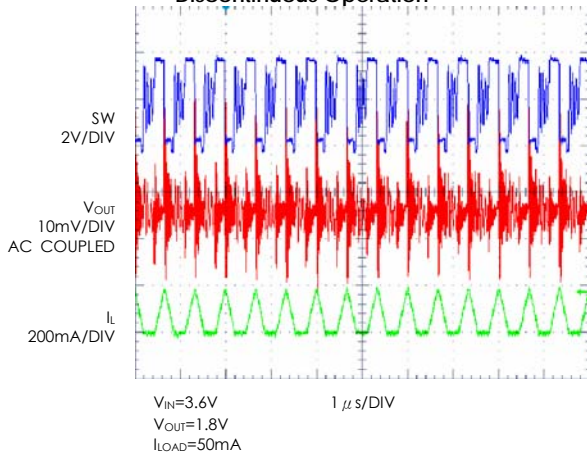

Start-up From Shutdown

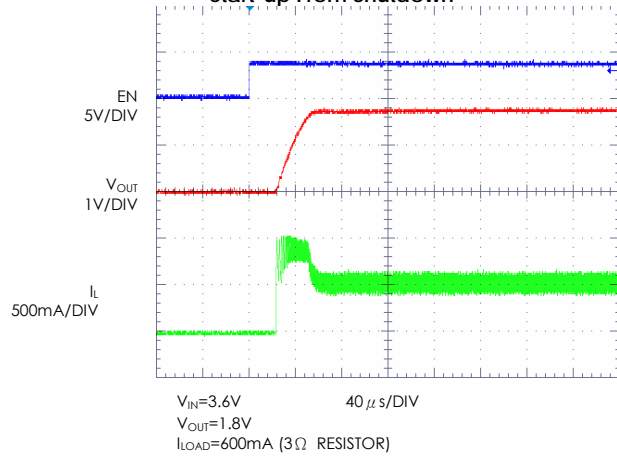

Load Step

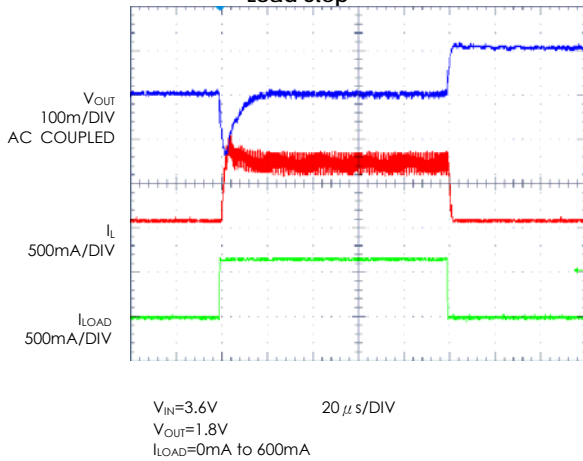

Load Step

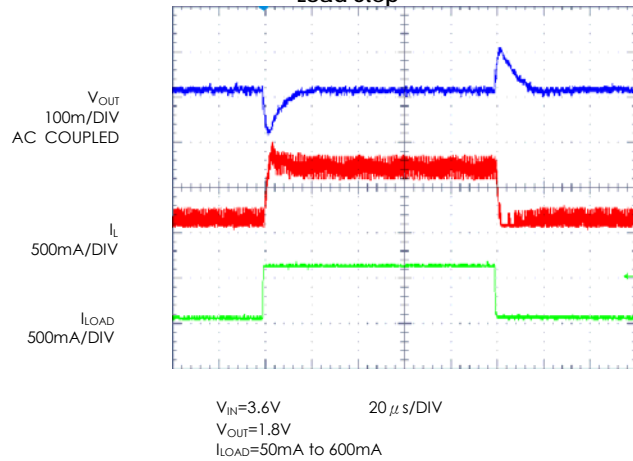

Load Step

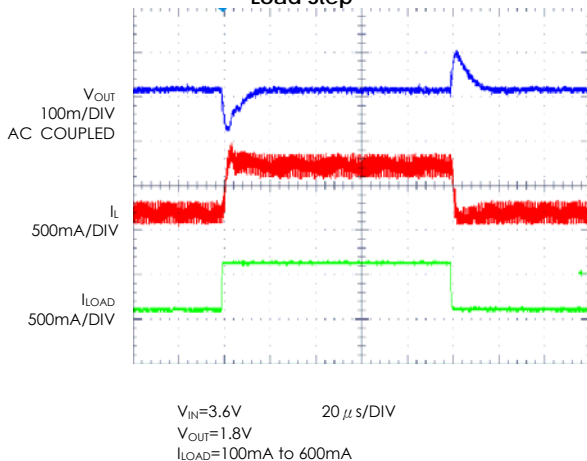

Load Step

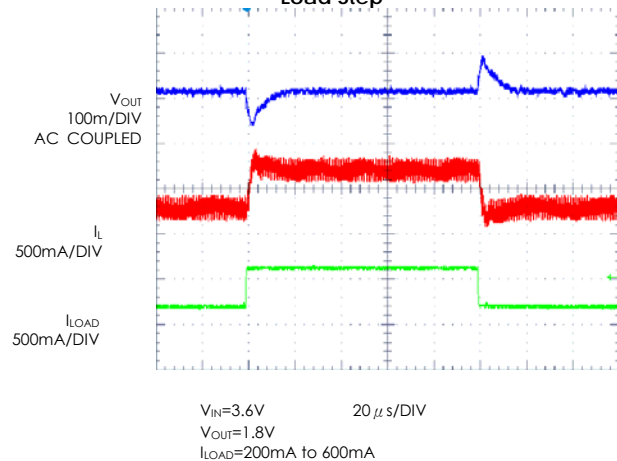

Functional Block Diagram

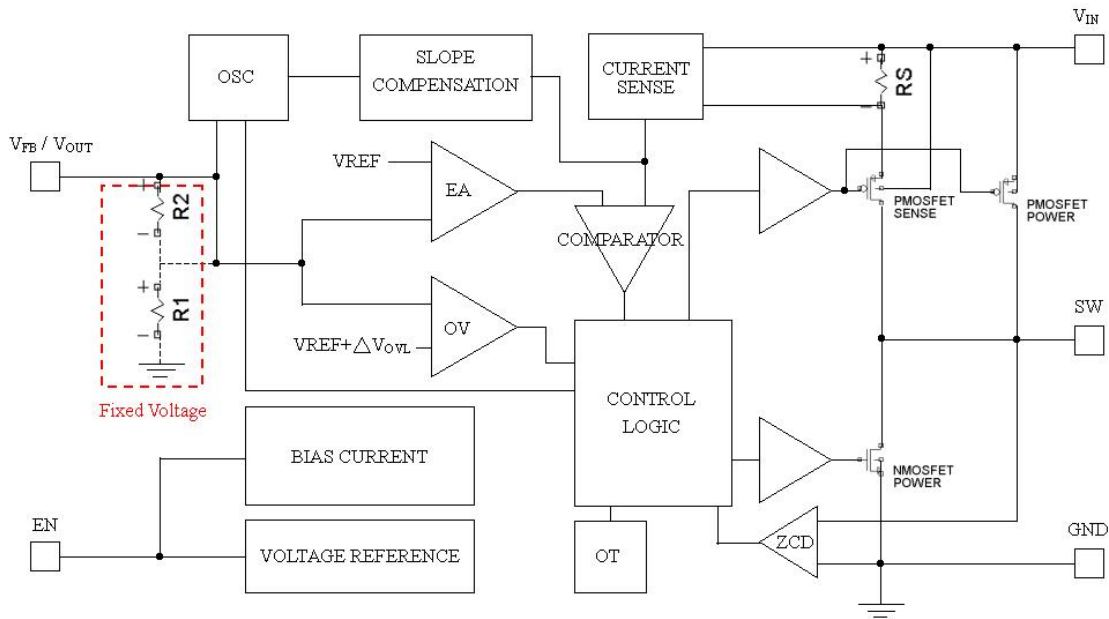

Applications

The typical application circuit of adjustable version is shown in Fig.1.

Fixed voltage version is shown below:

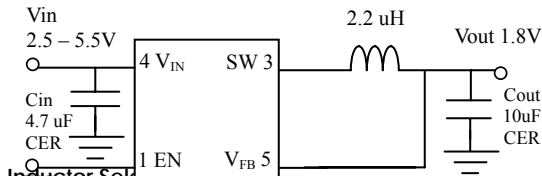

Inductor Selection

Basically, inductor ripple current and core saturation are two factors considered to decide the Inductor value.

$$\Delta I_L = \frac{1}{f \cdot L} V_{OUT} \left(1 - \frac{V_{OUT}}{V_{IN}} \right) \quad \text{Eq. 1}$$

The Eq. 1 shows the inductor ripple current is a function of frequency, inductance, Vin and Vout. It is recommended to set ripple current to 40% of max. load current. A low ESR inductor is preferred.

CIN and COUT Selection

A low ESR input capacitor can prevent large voltage transients at VIN. The RMS current of input capacitor is required larger than IRMS calculated by:

$$I_{RMS} \cong I_{OMAX} \frac{\sqrt{V_{OUT}(V_{IN} - V_{OUT})}}{V_{IN}} \quad \text{Eq. 2}$$

ESR is an important parameter to select COUT. The output ripple VOUT is determined by:

$$\Delta V_{OUT} \cong \Delta I_L \left(ESR + \frac{1}{8 \cdot f \cdot C_{OUT}} \right) \quad \text{Eq. 3}$$

Higher values, lower cost ceramic capacitors are now available in smaller sizes. These ceramic capacitors have high ripple currents, high voltage ratings and low ESR that make them ideal for switching regulator applications.

Optimize very low output ripple and small circuit size is doable from Cout selection since Cout does not affect the internal control loop stability. It is recommended to use the X5R or X7R which have the best temperature and voltage characteristics of all the ceramics for a given value and size.

Output Voltage (EML9366 adjustable)

In the adjustable version, the output voltage can be determined by:

$$V_{OUT} = 0.6 V \left(1 + \frac{R_2}{R_1} \right) \quad \text{Eq. 4}$$

Thermal Considerations

Although thermal shutdown is build-in in EML9366 that protect the device from thermal damage, the total power dissipation that EML9366 can sustain should be base on the package thermal capability. The formula to ensure the safe operation is shown in Note 1.

To avoid the EML9366 from exceeding the maximum junction temperature, the user will need to do some thermal analysis.

Guidelines for PCB Layout

To ensure proper operation of the EML9366, please note the following PCB layout guidelines:

1. The GND trace, the SW trace and the VIN trace should be kept short, direct and wide.
2. VFB pin must be connected directly to the feedback resistors. Resistive divider R1/R2 must be connected and parallel to the output capacitor COUT.
3. The Input capacitor CIN must be connected to pin VIN as closely as possible.
4. Keep SW node away from the sensitive VFB node since this node is with high frequency and voltage swing.
5. Keep the (-) plates of CIN and COUT as close as possible.

Applications (continued)

Output Voltage Ripple When V_{IN} Closes To V_{OUT}
 EML9366 goes into LDO mode when input voltage closes to output voltage. The transition from PWM mode to LDO mode is smooth. Bottom diagram shows the relationship of output voltage ripple versus input voltage when output voltage is 3.3V and EML9366 provides 200mA load current.

A 2.2 μ H inductor could be chose with this application. A greater inductor with less equivalent series resistance makes best efficiency. C_{IN} will require an RMS current rating of at least $I_{LOAD(MAX)}/2$ and low ESR. In most cases, a ceramic capacitor will satisfy this requirement.

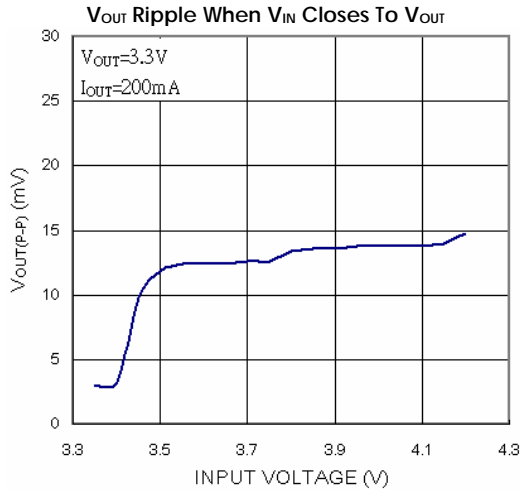

Design Example

Assume the EML9366 is used in a single lithium-ion battery-powered application. The V_{IN} range will be about 2.7V to 4.2V. Output voltage is 1.8V.

With this information we can calculate L using equation:

$$L = \frac{1}{f \cdot \Delta I_L} V_{OUT} \left(1 - \frac{V_{OUT}}{V_{IN}} \right)$$

Substituting $V_{OUT} = 1.8V$, $V_{IN} = 4.2V$, $\Delta I_L = 240mA$ and $f = 1.5MHz$ in eq. 1 gives:

$$L = \frac{1.8V}{1.5MHz \cdot 240mA} \left(1 - \frac{1.8V}{4.2V} \right) = 2.86\mu H$$

Application (Continued)

Typical schematic for PCB layout

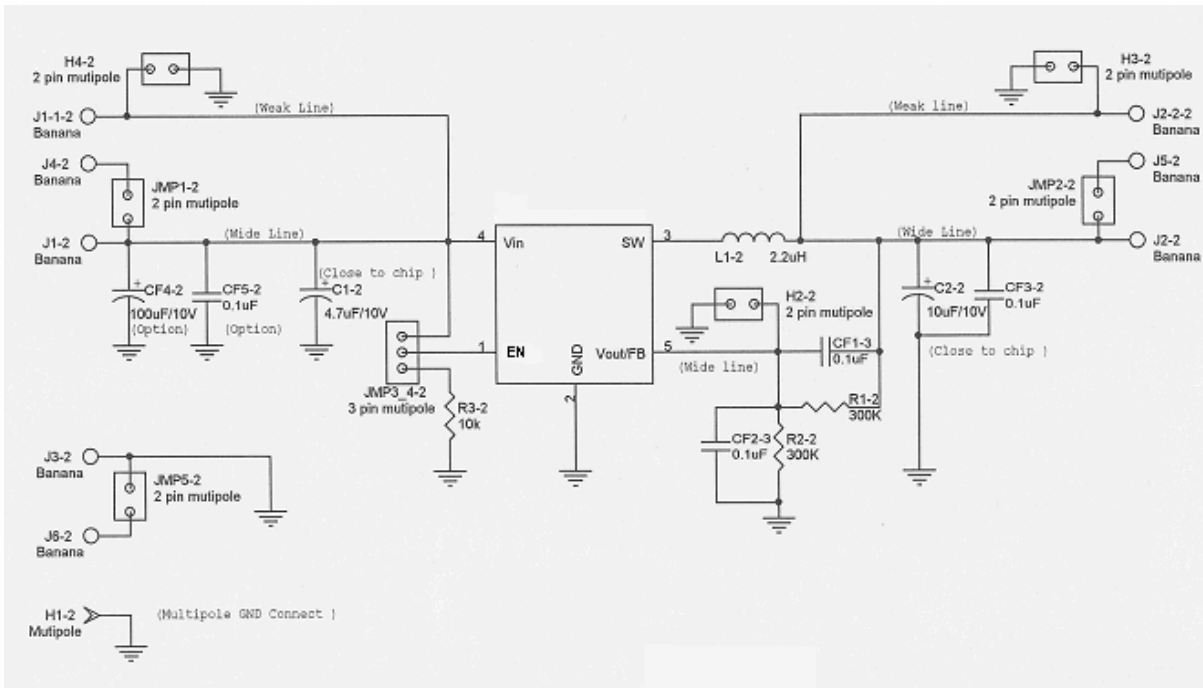

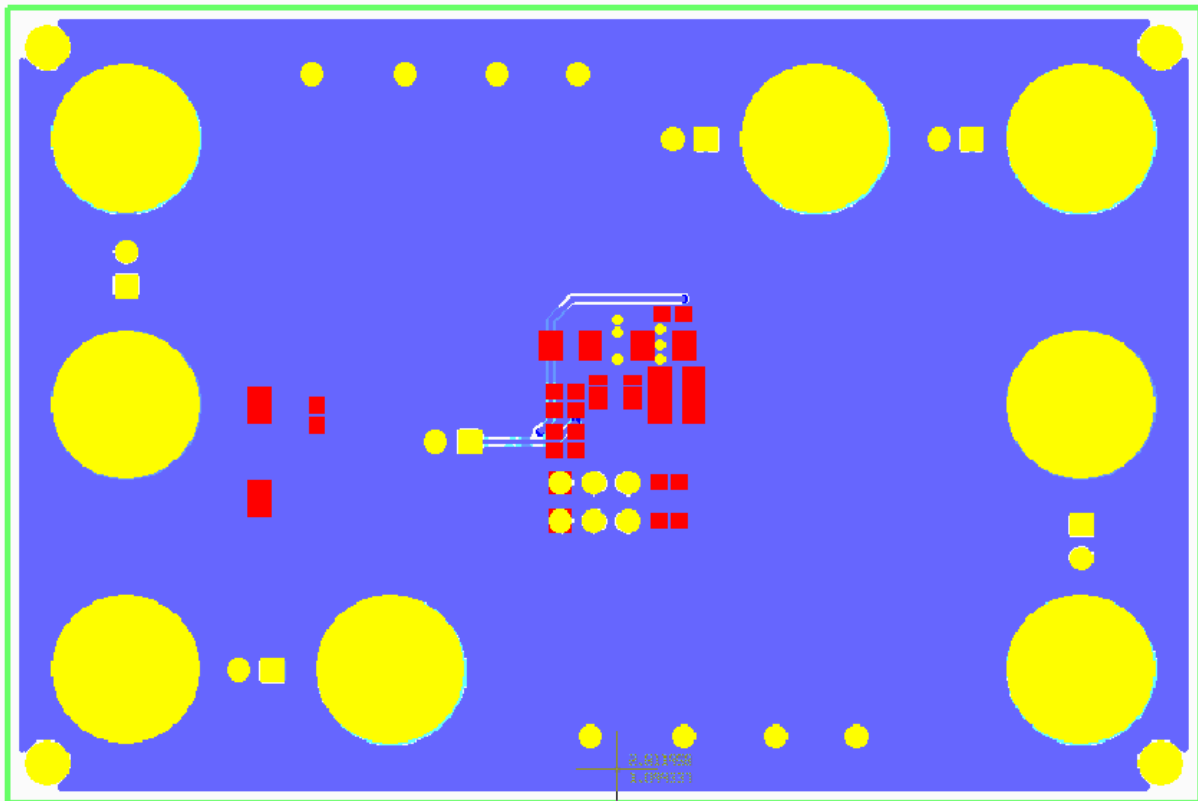
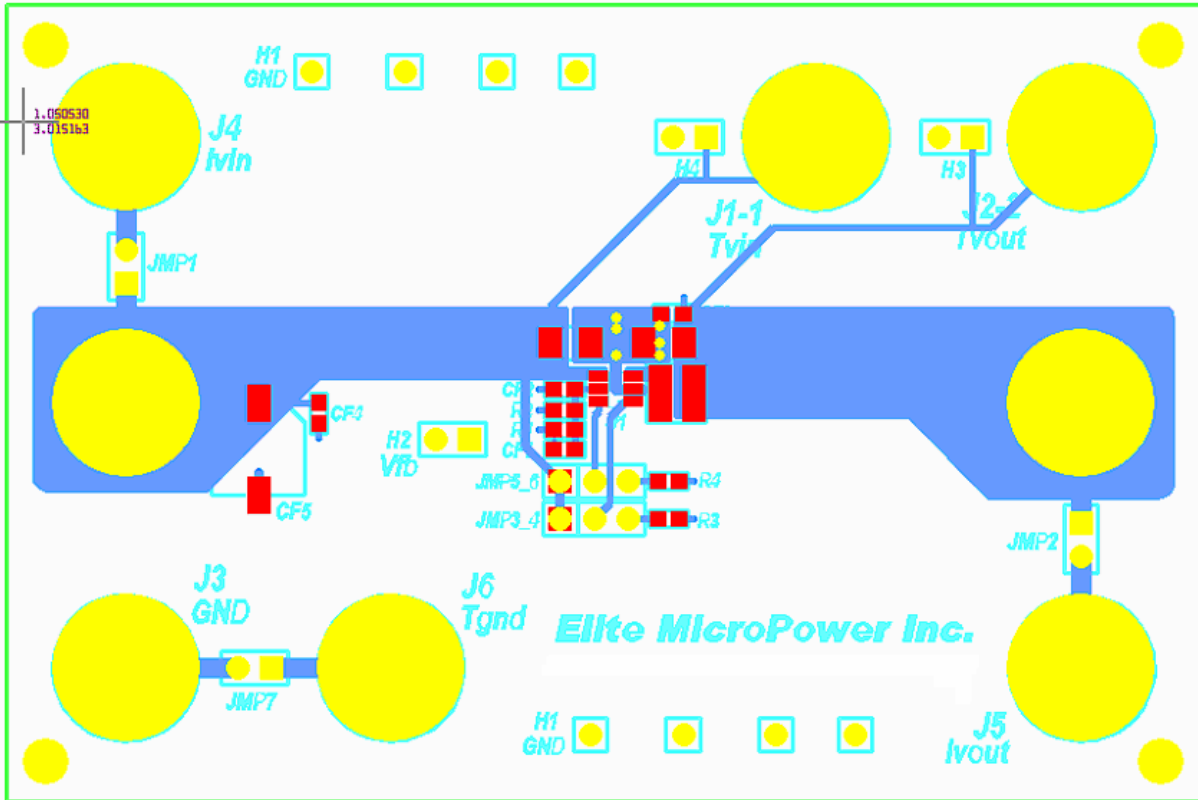

Package Information

SOT-23-5

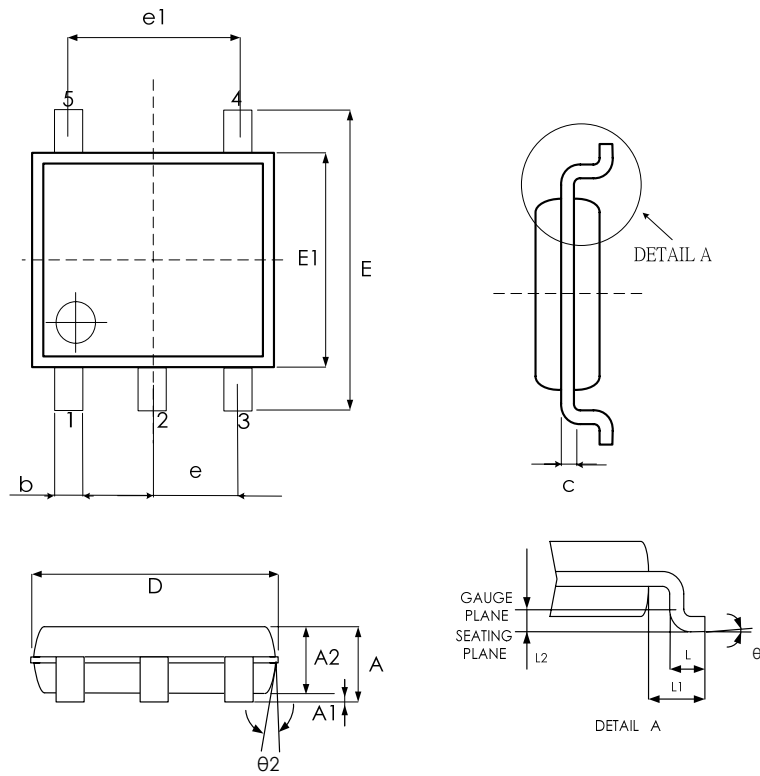

SYMBPLS	MIN.	NOM.	MAX.
A	1.05	1.20	1.35
A1	0.05	0.10	0.15
A2	1.00	1.10	1.20
b	0.30	—	0.50
c	0.08	—	0.20
D	2.80	2.90	3.00
E	2.60	2.80	3.00
E1	1.50	1.60	1.70
e	0.95 BSC		
e1	1.90 BSC		
L	0.30	0.45	0.55
L1	0.60 REF		
θ°	0	5	10
$\theta2^\circ$	6	8	10

UNIT: MM

Revision History

Revision	Date	Description
2.0	2009.06.09	EMP transferred from version 1.1
2.1	2011.01.28	Revise electrical characteristics (VEN)

Important Notice

All rights reserved.

No part of this document may be reproduced or duplicated in any form or by any means without the prior permission of ESMT.

The contents contained in this document are believed to be accurate at the time of publication. ESMT assumes no responsibility for any error in this document, and reserves the right to change the products or specification in this document without notice.

The information contained herein is presented only as a guide or examples for the application of our products. No responsibility is assumed by ESMT for any infringement of patents, copyrights, or other intellectual property rights of third parties which may result from its use. No license, either express, implied or otherwise, is granted under any patents, copyrights or other intellectual property rights of ESMT or others.

Any semiconductor devices may have inherently a certain rate of failure. To minimize risks associated with customer's application, adequate design and operating safeguards against injury, damage, or loss from such failure, should be provided by the customer when making application designs.

ESMT's products are not authorized for use in critical applications such as, but not limited to, life support devices or system, where failure or abnormal operation may directly affect human lives or cause physical injury or property damage. If products described here are to be used for such kinds of application, purchaser must do its own quality assurance testing appropriate to such applications.