

## 4-Channel Power Management IC For Portable Devices

### General Description

The EMQ8932 is a high efficiency, 4-channel power management IC for portable devices application. It integrates a complete linear charger for single cell lithium-ion battery, a linear regulator and two high efficiency step-down DC/DC converters.

The linear charger (CH1) operates from 4.25V to 5.5V input voltage and up to 1A charging capability. It is thermal regulated and specifically designed to work within USB power specifications.

The linear regulator (CH2) features ultra-high power supply rejection ratio (75dB at 1kHz), low output voltage noise (30 $\mu$ V), low dropout voltage (270mV), low quiescent current (110 $\mu$ A) and fast transient response. It operates from 2.5V to 5.5V input voltage, up to 600mA loading capability and regulates adjustable output voltage from 1.2V to 5.0V.

The two Synchronous Buck converters (CH3, CH4) operate from 2.5V to 5.5V input voltage, up to 600mA loading capability and regulate adjustable output voltage from 0.6V to VIN. It features low quiescent current, fixed 1.5MHz internal frequency operation.

The EMQ8932 is available in TQFN24 4x4 package, It is **Green compliant** (RoHS and Halogen-free).

### Features

- **Linear Charger**
  - \* 4.25V to 5.5V Input Voltage
  - \* Programmable charge current up to 1A
  - \* Thermal regulation maximizes charge rate without risk of overheating
  - \* Act as a LDO when battery is removed
  - \* Preset 4.2V charge voltage with  $\pm 1\%$  accuracy

- \* Automatic recharge
- \* Charge status indicator
- \* C/10 charge termination
- \* Battery reverse leakage current less than 1 $\mu$ A
- \* 45 $\mu$ A shutdown supply current
- \* Soft-start limits inrush current

- **Linear Regulator**

- \* 1.2V to 5.0V Output Voltage
- \* 75dB Typical PSRR at 1kHz
- \* 30 $\mu$ V RMS Output Voltage Noise (10Hz to 100kHz)
- \* 270mV Typical Dropout at 600mA

- **Two Synchronous Buck Converters**

- \* 0.6V to VIN Output Voltage
- \* Up to 95% Efficiency
- \* Low Dropout Operation: 100% Duty Cycle
- \* No Schottky Diode Needed

- Shutdown Current < 1 $\mu$ A (CH1-CH4)
- Independent Enable PIN(CH1-CH4)
- Independent Input Voltage PIN(CH1-CH4)
- No External Compensation Network needed
- Excellent Line and Load Transient Response(CH1-CH4)
- Over Current Protection
- Over Temperature Protection

### Applications

- Hand-held Instruments
- Portable information applications
- Wireless Networking
- GPS
- MP3/MP4/PMP Multi-media

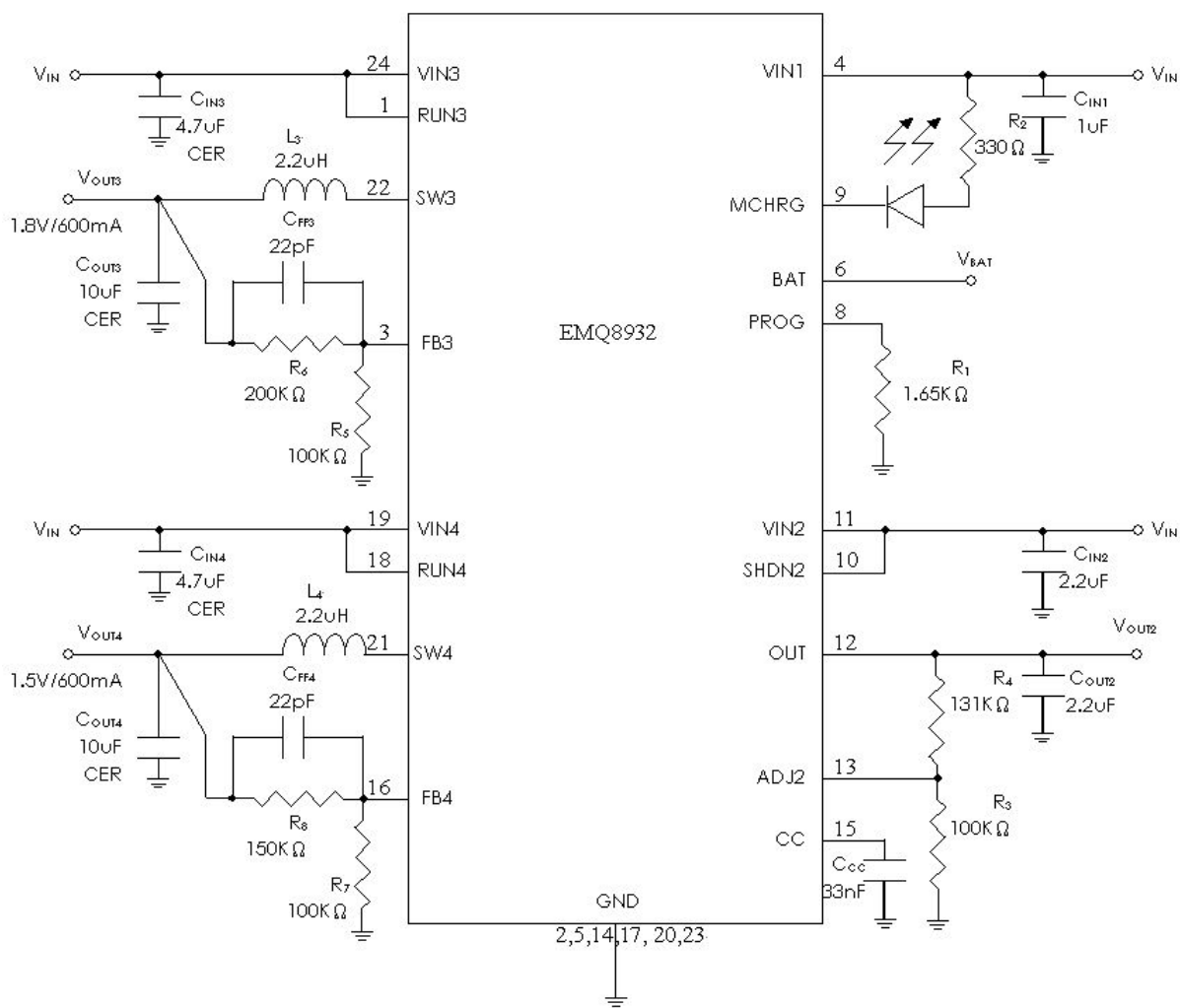
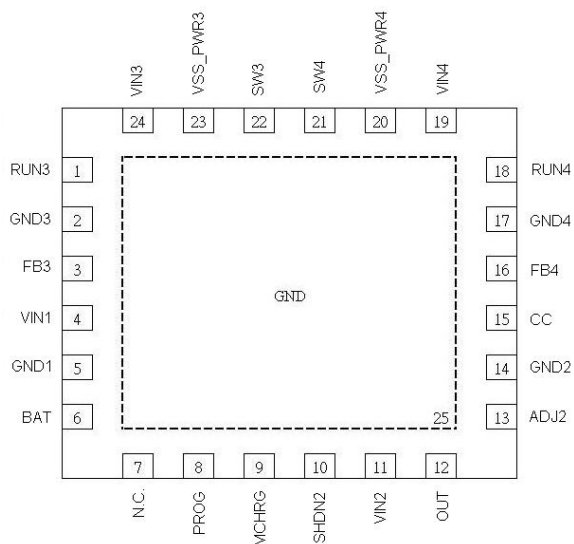

Figure 1. Typical Application

## Connection Diagram

TQFN24 4x4



## Order Information

EMQ8932-00HC24NRR

- 00 Adjustable output voltage
- HC24 TQFN-24 Package
- NRR RoHS & Halogen free  
Rating: -40 to 85°C  
Package in Tape & Reel

## Order, Mark & Packing Information

| Package | Product ID        | Marking   | Packing              |
|---------|-------------------|---|----------------------|
| TQFN-24 | EMQ8932-00HC24NRR | <div style="border: 1px solid black; padding: 5px; text-align: center;">                     EMP<br/>                     EMQ8932<br/>                     Tracking Code                 </div>  | 3K units Tape & Reel |

## Terminal Functions

| Terminal |     | I/O | Description   |
|----------|-----|-----|---|
| Name     | NO. |     |   |
| RUN3     | 1   | I   | CH3 Enable Input.   |
| GND3     | 2   | -   | Ground.   |
| FB3      | 3   | I   | CH3 Voltage Feedback PIN.   |
| VIN1     | 4   | I   | CH1 Positive Input Supply Voltage.  |
| GND1     | 5   | -   | Ground.   |
| BAT      | 6   | O   | CH1 Charge Current Output and battery voltage feedback.   |
| NC       | 7   | -   | Non-connection PIN.   |
| PROG     | 8   |     | CH1 Charge Current Program PIN, $I_{BAT}=(V_{PROG}/R_{PROG})*960$<br><b>The PROG pin must not be directly shorted to ground at any condition.</b> |
| MCHRG    | 9   | I   | CH1 Open-Drain Charge Status Output.  |
| SHDN2    | 10  | I   | CH2 Enable Input.   |
| VIN2     | 11  | I   | CH2 Input Voltage.  |
| OUT      | 12  | O   | CH2 Output Voltage Feedback.  |
| ADJ2     | 13  | I   | CH2 Adjustable Negative Feedback Control.   |
| GND2     | 14  | -   | Ground.   |
| CC       | 15  | I   | CH2 Compensation Capacitor.   |
| FB4      | 16  | I   | CH4 Voltage Feedback PIN.   |
| GND4     | 17  | -   | Ground.   |
| RUN4     | 18  | I   | CH4 Enable Input.   |
| VIN4     | 19  | I   | CH4 Input Voltage.  |
| VSS_PWR4 | 20  | -   | Ground.   |
| SW4      | 21  | O   | CH4 Switch PIN. Must be connected to Inductor.  |
| SW3      | 22  | O   | CH3 Switch PIN. Must be connected to Inductor.  |
| VSS_PWR3 | 23  | -   | Ground.   |
| VIN3     | 24  | I   | CH3 Input Voltage.  |

## Function Block Diagram

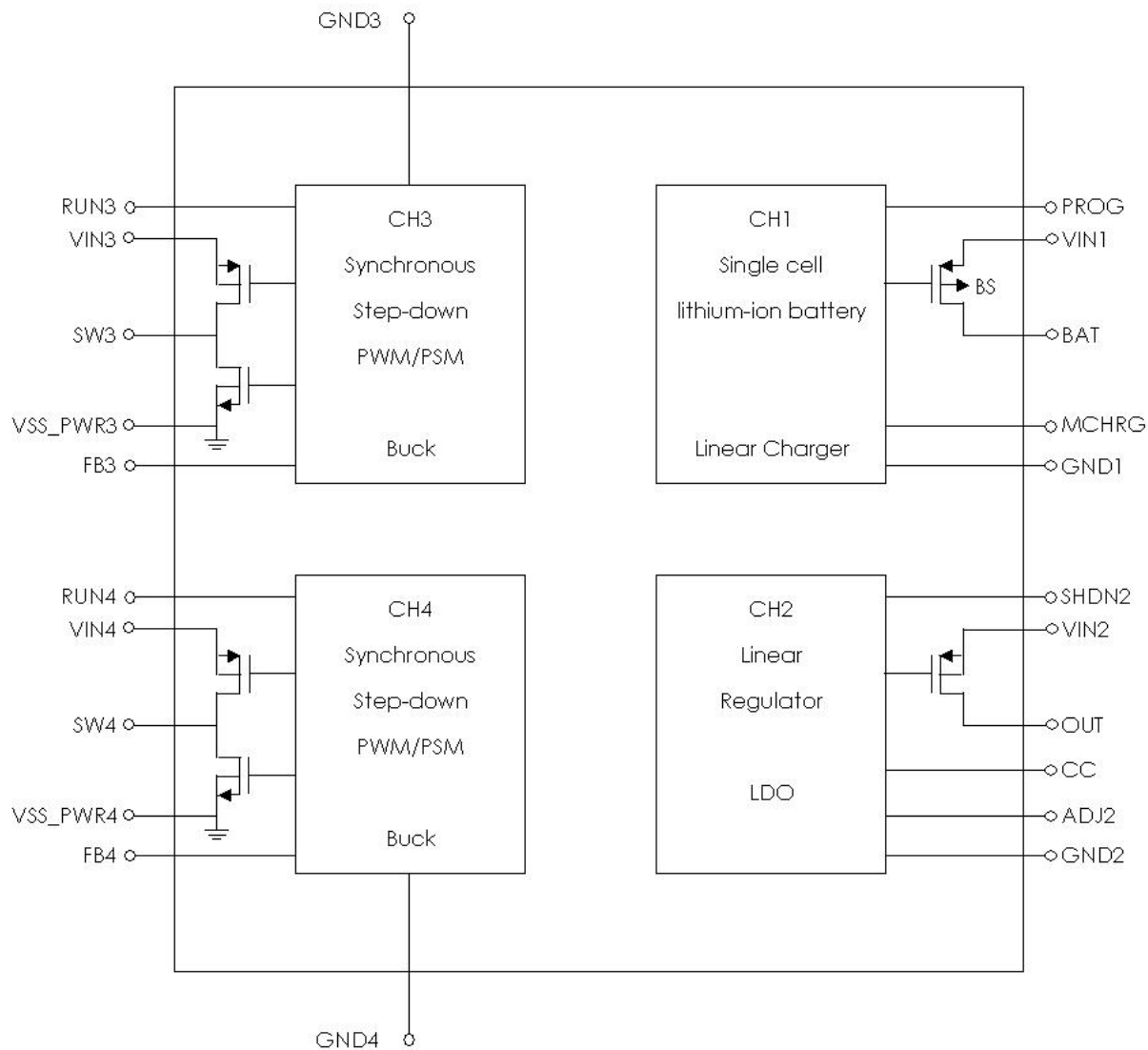

## Absolute Maximum Ratings

|   |                      |                            |                                |
|---|----------------------|----------------------------|--------------------------------|
| Supply Input Voltage<br>(VIN, VIN2, VIN3, VIN4) | -0.3V to 6.0V        | ESD Susceptibility         | HBM ----- 2KV<br>MM ----- 200V |
| BAT Pin Voltage                                 | -0.3V to 6.0V        | Junction Temperature       | 150°C                          |
| MCHRG Pin Voltage                               | -0.3V to 6.0V        | Thermal Resistance         |                                |
| PROG Pin Voltage                                | -0.3V to 6.0V        | $\theta_{JA}$ (TQFN24 4x4) | 45°C/W                         |
| SW3 Switch Pin Voltage                          | -0.3V to (VIN3+0.3V) | Operating Ratings          |                                |
| SW4 Switch Pin Voltage                          | -0.3V to (VIN4+0.3V) | Temperature Range          | -40°C $\leq$ TA $\leq$ 85°C    |
| Other I/O Pin Voltage                           | -0.3V to (VIN+0.3V)  | VIN Supply Voltage         | 4.25V $\leq$ VDD $\leq$ 5.5V   |
| Storage Temperature                             | -65°C to +150°C      | Supply Voltage             | 2.5V $\leq$ VDD $\leq$ 5.5V    |
| Power Dissipation                               | 1.85W                | (VIN2, VIN3, VIN4)         |                                |

## Electrical Characteristics

Apply for VIN=5.0V, VIN2 = VOUT2 + 1V (Note 6), VEN2 = VIN2, CIN2 = COUT2 = 2.2 $\mu$ F, C<sub>CC2</sub> = 33nF, VIN3 = 3.6V, VIN4 = 3.6V and TA = 25°C (unless otherwise noted), Boldface limits apply for the operating temperature extremes: -40°C and 85°C.

| Symbol               | Parameter   | Conditions  | EMQ8932 |     |       | Units   |
|----------------------|---|---|---------|-----|-------|---------|
|                      |   |   | Min     | Typ | Max   |         |
| <b>CH1</b>           |   |   |         |     |       |         |
| V <sub>IN</sub>      | Input voltage                                       |   | 4.25    |     | 5.5   | V       |
| I <sub>CC</sub>      | Input Supply Current                                | Charge Mode, R <sub>PROG</sub> =10K (Note 4)  |         | 260 |       | $\mu$ A |
|                      |   | Standby Mode (Charge Terminated)  |         | 106 |       |         |
|                      |   | Shutdown Mode (R <sub>PROG</sub> Not Connected, V <sub>IN</sub> <V <sub>BAT</sub> or V <sub>IN</sub> <V <sub>UV</sub> ) |         | 45  |       |         |
| V <sub>FLOAT</sub>   | Regulated Output (Float) Voltage                    | 0°C $\leq$ TA $\leq$ 85°C   | 4.158   | 4.2 | 4.242 | V       |
| I <sub>BAT</sub>     | BAT Pin Current                                     | R <sub>PROG</sub> =2K, Current Mode   |         | 480 |       | mA      |
|                      |   | Standby Mode, V <sub>BAT</sub> =4.2V  | -1      | 0   | 1     | $\mu$ A |
|                      |   | Shutdown Mode (R <sub>PROG</sub> Not Connected)   | -1      | 0   | 1     |         |
|                      |   | Sleep Mode, V <sub>IN</sub> =0V   | -1      | 0   | 1     |         |
| I <sub>TRICKLE</sub> | Trickle Charge Current                              | V <sub>BAT</sub> <V <sub>TRICKLE</sub> , R <sub>PROG</sub> =2K  |         | 50  |       | mA      |
| V <sub>TRICKLE</sub> | Trickle Charge Threshold Voltage                    | R <sub>PROG</sub> =10K, V <sub>BAT</sub> Rising   |         | 2.9 |       | V       |
| V <sub>TRHYS</sub>   | Trickle Charge Hysteresis Voltage                   | R <sub>PROG</sub> =10K  |         | 210 |       | mV      |
| V <sub>UV</sub>      | V <sub>IN</sub> Under voltage Lockout Threshold     | From VIN Low to High  |         | 3.0 |       | V       |
| V <sub>UVHYS</sub>   | V <sub>IN</sub> Under voltage Lockout Hysteresis    |   |         | 180 |       | mV      |
| V <sub>ASD</sub>     | V <sub>IN</sub> -V <sub>BAT</sub> Lockout Threshold | V <sub>IN</sub> from Low to High  |         | 80  |       | mV      |

|                     |   |   |      |       |     |                      |
|---------------------|---|---|------|-------|-----|----------------------|
|                     | Voltage   | $V_{IN}$ from High to Low   |      | 30    |     | mV                   |
| $I_{TERM}$          | C/10 Termination Current Threshold                | $R_{PROG}=10K$  |      | 0.1   |     | mA/mA                |
| $V_{PROG}$          | PROG Pin Voltage                                  | $R_{PROG}=10K$ , Current Mode   |      | 1.0   |     | V                    |
| $I_{CHGB}$          | CHGB Pin Weak Pull-Down Current                   | $V_{CHGB}=5V$   |      | 24    |     | $\mu A$              |
| $V_{CHGB}$          | CHGB Pin Output Low Voltage                       | $I_{CHGB} = 5mA$  |      | 0.23  |     | V                    |
| $V_{RECHRG}$        | Recharge Battery Threshold Voltage                | $V_{FLOAT}-V_{RECHRG}$  |      | 160   |     | mV                   |
| $T_{ILM}$           | Junction Temperature in Constant Temperature Mode |   |      | 120   |     | $^{\circ}C$          |
| $R_{ON}$            | Power FET "ON" Resistance                         |   |      | 450   |     | $m\Omega$            |
| $T_{SS}$            | Soft-Start Time                                   | $I_{BAT}=0$ to $I_{BAT}=960V/R_{PROG}$  |      | 100   |     | $\mu s$              |
| $T_{RECHARGE}$      | Recharge Comparator Filter Time                   | $V_{BAT}$ High to Low   |      | 2.4   |     | ms                   |
| $T_{TERM}$          | Termination Comparator Filter Time                | $I_{BAT}$ Falling Below $I_{CHG}/10$  |      | 1.1   |     | ms                   |
| $I_{PROG}$          | PROG Pin Pull-up Current                          |   |      | 0.4   |     | $\mu A$              |
| <b>CH2 (note 8)</b> |   |   |      |       |     |                      |
| $V_{IN2}$           | Input Voltage                                     |   | 2.5  |       | 5.5 | V                    |
| $\Delta V_{OUT2}$   | Output Voltage Tolerance                          | $100\mu A \leq I_{OUT2} \leq 300mA$<br>$V_{OUT2 (NOM)} + 0.5V \leq V_{IN2} \leq 5.5V$ (Note 5)<br>$ADJ2=V_{OUT2}$ | -2   |       | +2  | % of $V_{OUT (NOM)}$ |
|                     |   |   | -3   |       | +3  |                      |
| $V_{OUT2}$          | Output Adjust Range                               |   | 1.20 |       | 5.0 | V                    |
| $I_{OUT2}$          | Maximum Output Current                            | Average DC Current Rating   | 600  |       |     | mA                   |
| $I_{LIMIT2}$        | Output Current Limit                              |   | 600  | 950   |     | mA                   |
| $I_{Q2}$            | Supply Current                                    | $I_{OUT2} = 0mA$  |      | 110   |     | $\mu A$              |
|                     |   | $I_{OUT2} = 600mA$  |      | 255   |     |                      |
|                     | Shutdown Supply Current                           | $V_{OUT2} = 0V$ , $EN2 = GND$   |      | 0.001 | 1   |                      |
| $V_{DO2}$           | Dropout Voltage (Note 5)                          | $I_{OUT2} = 50mA$   |      | 19    |     | mV                   |
|                     |   | $I_{OUT2} = 300mA$  |      | 110   |     |                      |
|                     |   | $I_{OUT2} = 600mA$  |      | 230   |     |                      |
| $\Delta V_{OUT2}$   | Line Regulation                                   | $I_{OUT2} = 1mA$ , $(V_{OUT2} + 0.5V) \leq V_{IN2} \leq 5.5V$ (Note 6)  | -0.1 | 0.02  | 0.1 | %/V                  |
|                     | Load Regulation                                   | $100\mu A \leq I_{OUT2} \leq 600mA$   |      | 0.001 |     | %/mA                 |

|                     |                                   |  |              |              |              |                            |
|---------------------|-----------------------------------|--|--------------|--------------|--------------|----------------------------|
| $\epsilon_{n2}$     | Output Voltage Noise              | $I_{OUT2} = 10\text{mA}$ , $10\text{Hz} \leq f \leq 100\text{kHz}$                         |              | 30           |              | $\mu\text{V}_{\text{RMS}}$ |
| $V_{EN2}$           | EN2 Input Threshold               | $V_{IH}$ , $(V_{OUT} + 0.5\text{V}) \leq V_{IN} \leq 5.5\text{V}$<br>(Note 8)              | <b>1.2</b>   |              |              | V                          |
|                     |                                   | $V_{IL}$ , $(V_{OUT} + 0.5\text{V}) \leq V_{IN} \leq 5.5\text{V}$<br>(Note 8)              |              |              | <b>0.4</b>   |                            |
| $I_{EN2}$           | EN2 Input Bias Current            | EN2 = GND or $V_{IN}$  |              | 0.1          | 100          | nA                         |
| $I_{ADJ2}$          | ADJ2 Input Leakage                | ADJ2=1.3V (Note 7)   |              | 0.1          | 3            | nA                         |
| $T_{SD}$            | Thermal Shutdown Temperature      | (Note 8)   |              | 165          |              | $^{\circ}\text{C}$         |
| $T_{SD\_HYST}$      | Thermal Shutdown Hysteresis       |  |              | 30           |              | $^{\circ}\text{C}$         |
| $T_{ON2}$           | Start-Up Time                     | $C_{OUT2} = 10\mu\text{F}$ , $V_{OUT2}$ at 90% of Final Value                              |              | 80           |              | $\mu\text{s}$              |
| <b>CH3 (Note 8)</b> |                                   |  |              |              |              |                            |
| $I_{VFB3}$          | Feedback Current                  |  |              |              | $\pm 30$     | nA                         |
| $V_{FB3}$           | Regulated Feedback Voltage        | $T_A = 25^{\circ}\text{C}$   | 0.588        | 0.600        | 0.612        | V                          |
|                     |                                   | $-40^{\circ}\text{C} \leq T_A \leq 85^{\circ}\text{C}$                                     | <b>0.585</b> | <b>0.600</b> | <b>0.615</b> |                            |
| $\Delta V_{FB3}$    | Reference Voltage Line Regulation | $V_{IN3} = 2.5\text{V to } 5.5\text{V}$  |              |              | <b>0.4</b>   | %/V                        |
| $\Delta V_{OVL3}$   | Output Over-voltage Lockout       | $\Delta V_{OVL3} = V_{OVL3} - V_{FB3}$   | 20           | 50           | 80           | mV                         |
| $\Delta V_{OUT3}$   | Output Voltage Line Regulation    | $V_{IN3} = 2.5\text{V to } 5.5\text{V}$  |              |              | <b>0.4</b>   | %/V                        |
|                     | Output Voltage Load Regulation    |  |              | 0.5          |              | %                          |
| $I_{PK3}$           | Peak Inductor Current             | $V_{IN3} = 3\text{V}$ , $V_{FB3} = 0.5\text{V}$ or $V_{OUT3} = 90\%$ ,<br>Duty Cycle < 35% |              | 1.0          |              | A                          |
| $I_{Q3}$            | Quiescent Current (Note 9)        | $V_{FB3} = 0.5\text{V}$ or $V_{OUT3} = 90\%$   |              | 200          | 340          | $\mu\text{A}$              |
|                     | Shutdown                          | $V_{EN3} = 0\text{V}$ , $V_{IN3} = 4.2\text{V}$  |              | 0.1          | 1            | $\mu\text{A}$              |
| $f_{OSC3}$          | Oscillator Frequency              | $V_{FB3} = 0.6\text{V}$ or $V_{OUT3} = 100\%$  | <b>1.2</b>   | <b>1.5</b>   | <b>1.8</b>   | MHz                        |
|                     |                                   | $V_{FB3} = 0\text{V}$ or $V_{OUT3} = 0\text{V}$  |              | <b>290</b>   |              | kHz                        |
| $R_{PFET3}$         | $R_{DS(ON)}$ of PMOS              | $I_{SW3} = 100\text{mA}$   |              | 0.45         | 0.55         | $\Omega$                   |
| $R_{NFET3}$         | $R_{DS(ON)}$ of NMOS              | $I_{SW3} = -100\text{mA}$  |              | 0.40         | 0.5          | $\Omega$                   |
| $I_{SW3}$           | SW3 Leakage                       | $V_{EN3} = 0\text{V}$ , $V_{SW3} = 0\text{V}$ or $5\text{V}$ ,<br>$V_{IN3} = 5\text{V}$    |              |              | $\pm 1$      | $\mu\text{A}$              |
| $V_{EN3}$           | EN3 Threshold                     |  | 0.5          |              | 1.3          | V                          |
| $I_{EN3}$           | EN3 Leakage Current               |  |              |              | $\pm 1$      | $\mu\text{A}$              |
| <b>CH4 (Note8)</b>  |                                   |  |              |              |              |                            |
| $I_{VFB4}$          | Feedback Current                  |  |              |              | $\pm 30$     | nA                         |



|                    |                                   |  |              |              |              |     |
|--------------------|-----------------------------------|--|--------------|--------------|--------------|-----|
| V <sub>FB4</sub>   | Regulated Feedback Voltage        | T <sub>A</sub> = 25°C  | 0.588        | 0.600        | 0.612        | V   |
|                    |                                   | -40°C ≤ T <sub>A</sub> ≤ 85°C  | <b>0.585</b> | <b>0.600</b> | <b>0.615</b> |     |
| ΔV <sub>FB4</sub>  | Reference Voltage Line Regulation | V <sub>IN4</sub> = 2.5V to 5.5V  |              |              | <b>0.4</b>   | %/V |
| ΔV <sub>OVL4</sub> | Output Over-voltage Lockout       | ΔV <sub>OVL4</sub> = V <sub>OVL4</sub> - V <sub>FB4</sub>                                      | 20           | 50           | 80           | mV  |
| ΔV <sub>OUT4</sub> | Output Voltage Line Regulation    | V <sub>IN4</sub> = 2.5V to 5.5V  |              |              | <b>0.4</b>   | %/V |
|                    | Output Voltage Load Regulation    |  |              | 0.5          |              | %   |
| I <sub>PK4</sub>   | Peak Inductor Current             | V <sub>IN4</sub> = 3V, V <sub>FB4</sub> = 0.5V or V <sub>OUT4</sub> = 90%,<br>Duty Cycle < 35% |              | 1.0          |              | A   |
| I <sub>Q4</sub>    | Quiescent Current (Note 9)        | V <sub>FB4</sub> = 0.5V or V <sub>OUT4</sub> = 90%   |              | 200          | 340          | μA  |
|                    | Shutdown                          | V <sub>EN4</sub> = 0V, V <sub>IN4</sub> = 4.2V   |              | 0.1          | 1            | μA  |
| f <sub>OSC4</sub>  | Oscillator Frequency              | V <sub>FB4</sub> = 0.6V or V <sub>OUT4</sub> = 100%  | <b>1.2</b>   | <b>1.5</b>   | <b>1.8</b>   | MHz |
|                    |                                   | V <sub>FB4</sub> = 0V or V <sub>OUT4</sub> = 0V  |              | <b>290</b>   |              | kHz |
| R <sub>PFET4</sub> | R <sub>DS(ON)</sub> of PMOS       | I <sub>SW4</sub> = 100mA   |              | 0.45         | 0.55         | Ω   |
| R <sub>NFET4</sub> | R <sub>DS(ON)</sub> of NMOS       | I <sub>SW4</sub> = -100mA  |              | 0.40         | 0.5          | Ω   |
| I <sub>SW4</sub>   | SW4 Leakage                       | V <sub>EN4</sub> = 0V, V <sub>SW4</sub> = 0V or 5V,<br>V <sub>IN4</sub> = 5V                   |              |              | ±1           | μA  |
| V <sub>EN4</sub>   | EN4 Threshold                     |  | 0.5          |              | 1.3          | V   |
| I <sub>EN4</sub>   | EN4 Leakage Current               |  |              |              | ±1           | μA  |

**Note 1:** Absolute Maximum ratings indicate limits beyond which damage may occur. Electrical specifications do not apply when operating the device outside of its rated operating conditions.

**Note 2:** All voltages are with respect to the potential at the ground pin.

**Note 3:** Maximum Power dissipation for the device is calculated using the following equations:

$$P_D = \frac{T_{J(MAX)} - T_A}{\theta_{JA}}$$

where T<sub>J(MAX)</sub> is the maximum junction temperature, T<sub>A</sub> is the ambient temperature, and θ<sub>JA</sub> is the junction-to-ambient thermal resistance.

**Note 4:** CH1 Supply current includes PROG pin current (approximately 100μA) but does not include any current delivered to the battery through the BAT pin (approximately 96mA).

**Note 5:** CH2 does not apply to input voltages below 2.5V since this is the minimum input operating voltage.

**Note 6:** CH2 Dropout voltage is measured by reducing V<sub>IN</sub> until V<sub>OUT</sub> drops 100mV from its nominal value at V<sub>IN</sub> - V<sub>OUT</sub> = 0.5V. Dropout voltage does not apply to the regulator versions with V<sub>OUT</sub> less than 2.5V.

**Note 7:** CH2 The ADJ2 pin is disconnected internally for the preset versions.

**Note 8:** CH2, CH3 and CH4 build-in internal over-temperature protection to prevent over-load condition.

**Note 9:** Dynamic quiescent current is higher due to the gate charge delivered at the switching frequency.

## Typical Performance Characteristics

$V_{IN}=5.0V$ ,  $V_{IN2} = V_{OUT2(NOM)} + 1V$ ,  $C_{IN2} = C_{OUT2} = 2.2\mu F$ ,  $C_{CC} = 33nF$ ,  $V_{EN2} = V_{IN2}$ ,  $V_{EN3} = V_{IN3}$ ,  $C_{IN3}=4.7\mu F$ ,  $L_3=2.2\mu H$ ,  $C_{OUT3}=4.7\mu F$ ,  $C_{IN4}=4.7\mu F$ ,  $L_4=2.2\mu H$ ,  $C_{OUT4}=4.7\mu F$ ,  $V_{EN4} = V_{IN4}$   $T_A = 25^\circ C$ , unless otherwise specified

CH1 Regulated Output (Float) Voltage vs Temperature

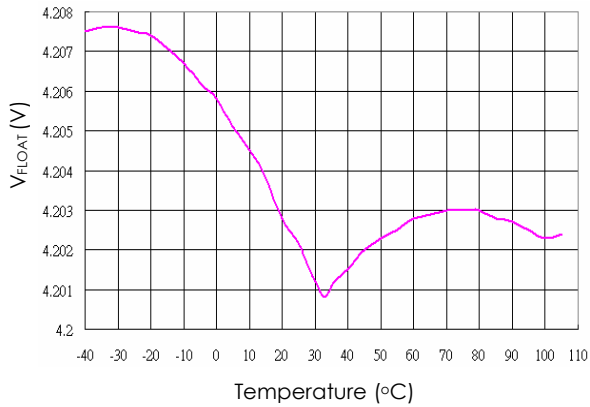

CH1 Charge Current vs Battery Voltage

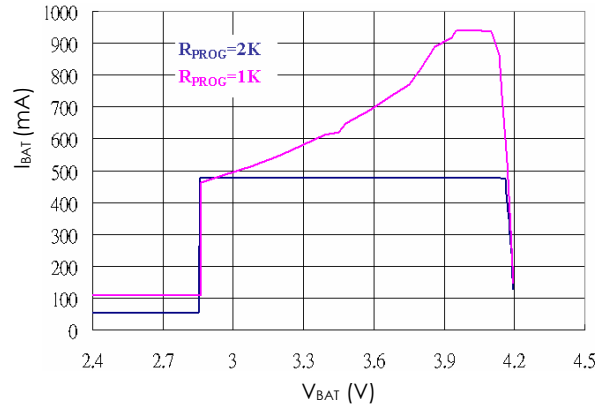

CH1 Charge Current vs Supply Voltage

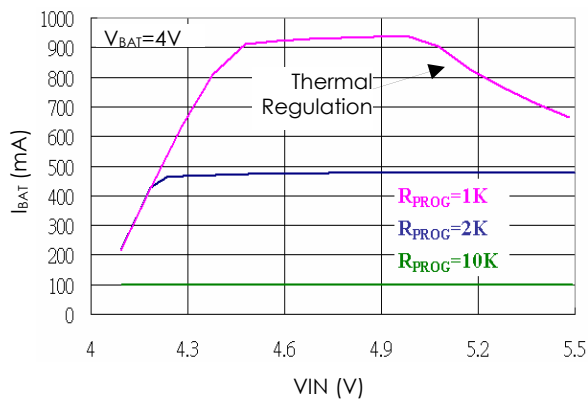

CH1 Charge Current vs Ambient Temperature

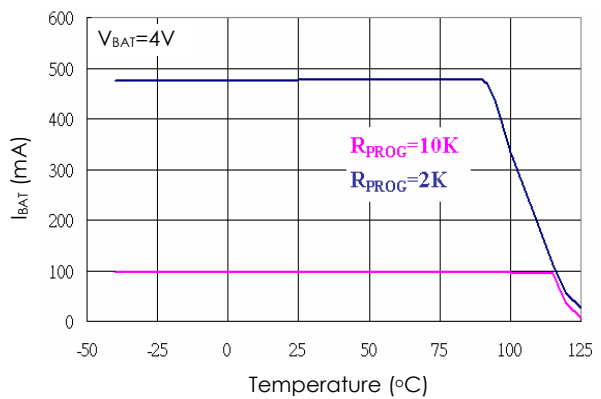

CH1 Regulated Output (Float) Voltage vs Supply Voltage

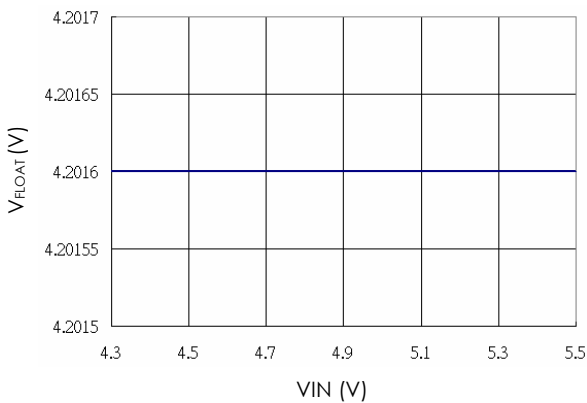

CH1 CHGB Pin I-V Curve (Strong Pull-Down State)

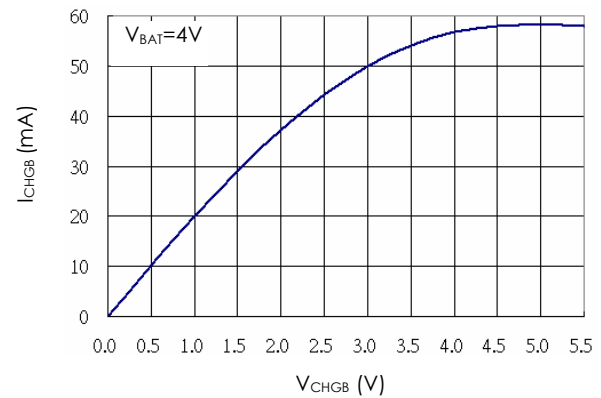

CH1 Load Transient (Battery Removed)

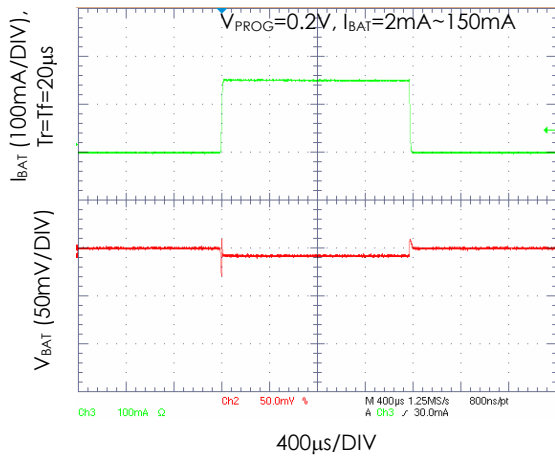

CH1 Line Transient (Battery Removed)

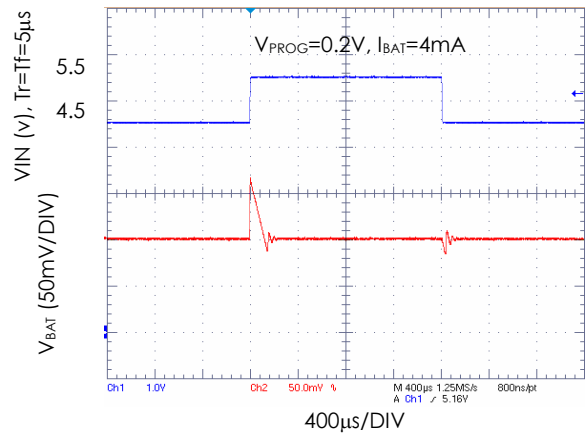

CH1 CHGB Pin Current vs Temperature (Strong Pull-Down State)

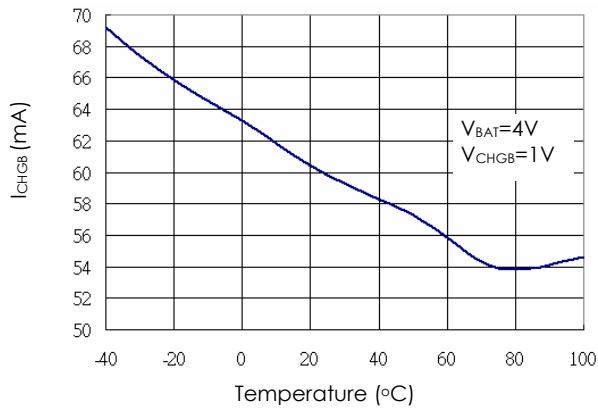

CH1 CHGB Pin I-V Curve (Weak Pull-Down State)

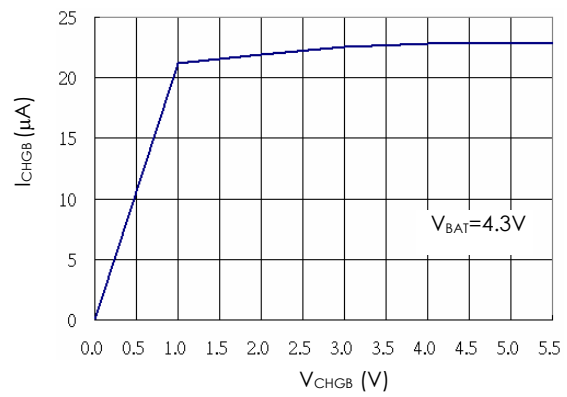

CH1 CHGB Pin Current vs Temperature (Weak Pull-Down State)

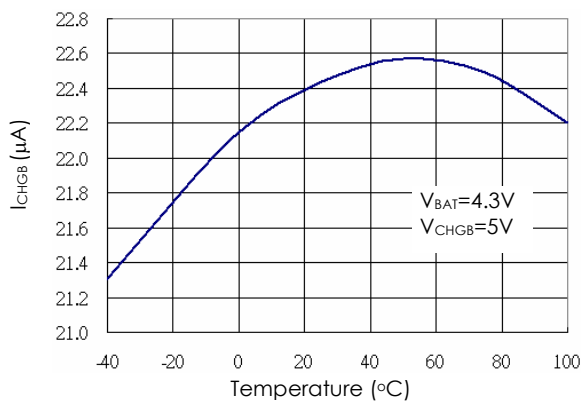

CH1 Trickle Charge Current vs Temperature

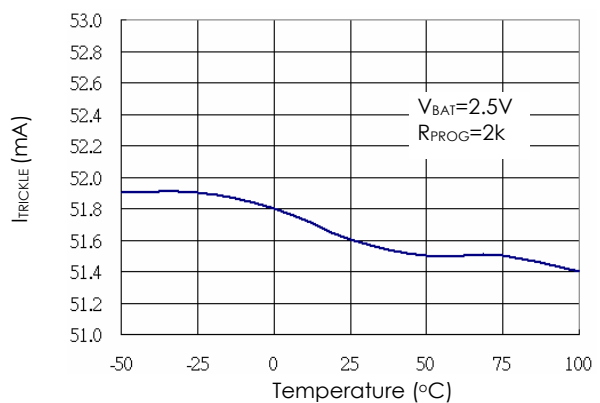

CH1 Trickle Charge Current vs Supply Voltage

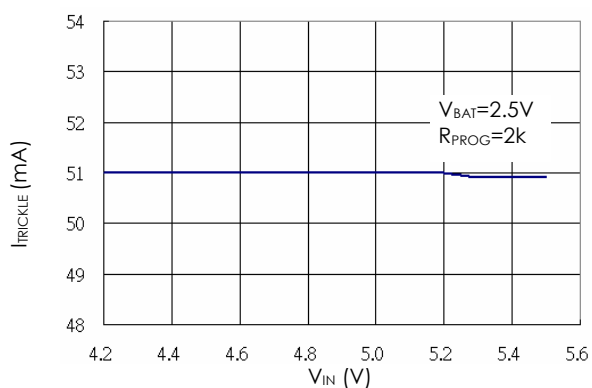

CH1 Trickle Charge Threshold vs Temperature

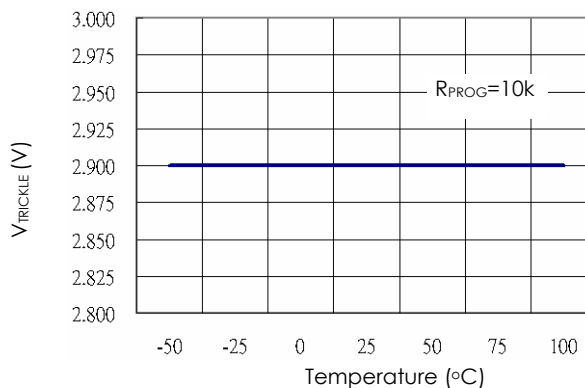

CH1 Recharge Voltage Threshold vs Temperature

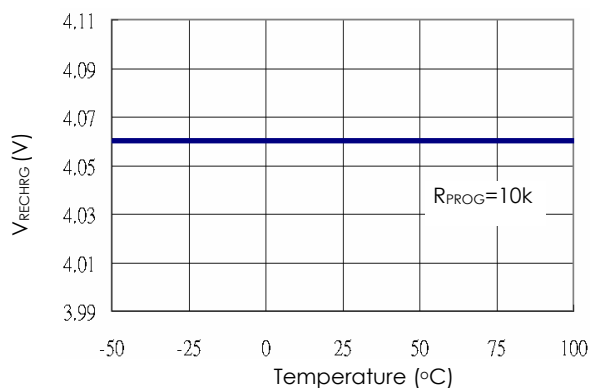

CH1 Regulated Output (Float) Voltage vs Charge Current

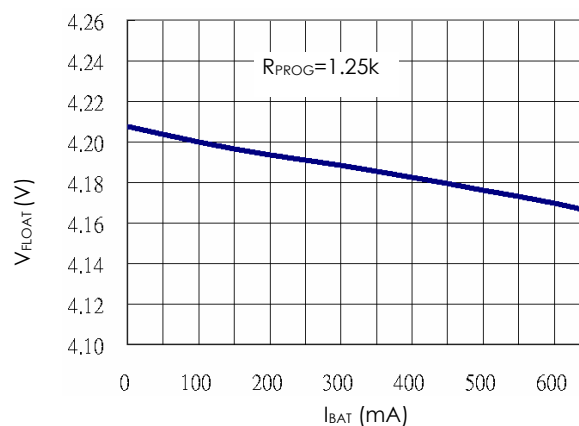

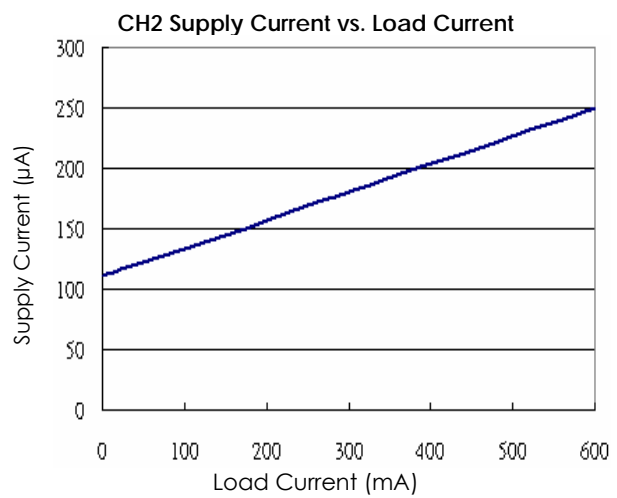
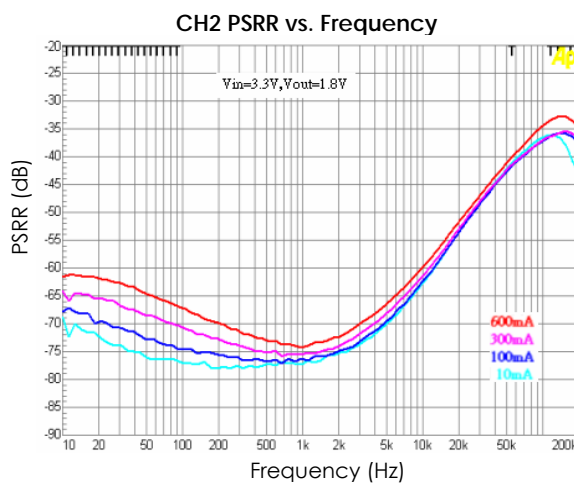
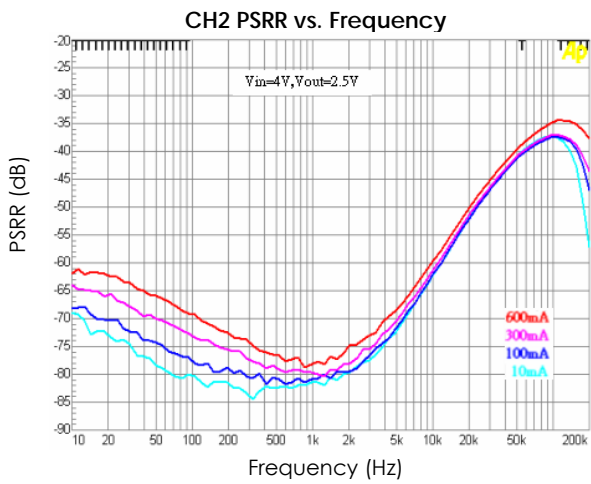
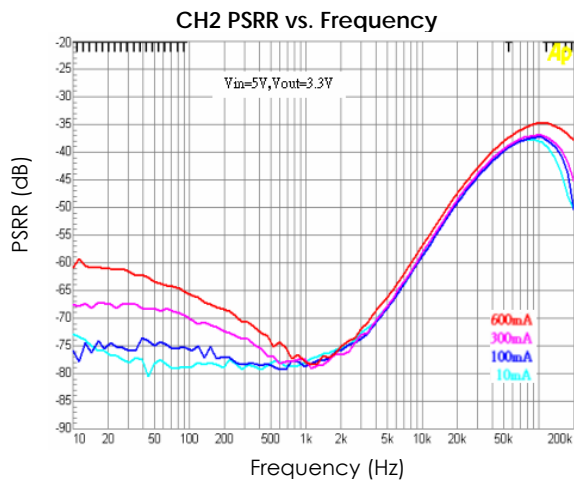
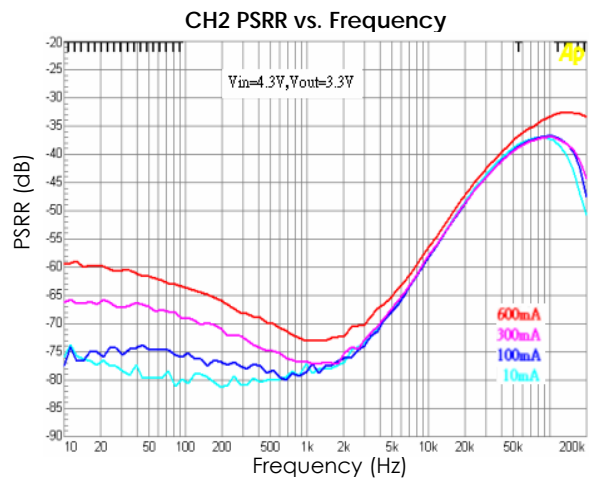
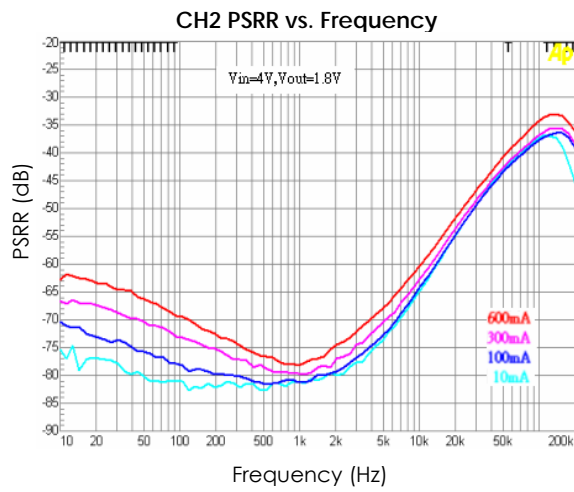

CH2 Dropout Voltage vs. Load Current

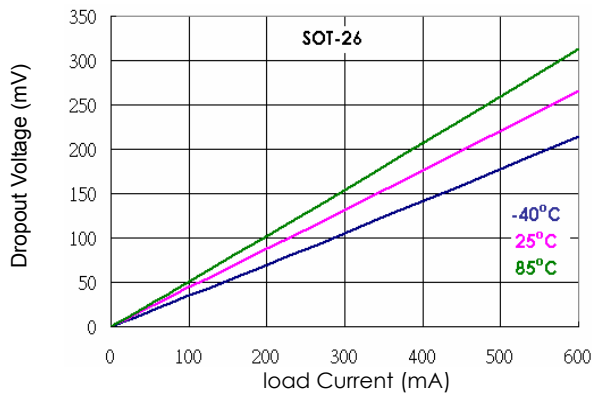

CH2 Supply Current vs. Input Voltage

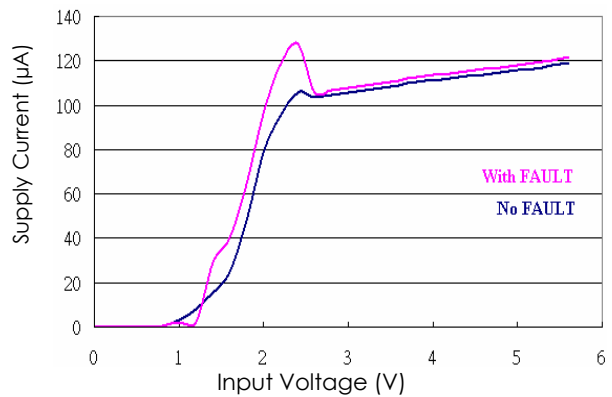

CH2 Enable and Disable

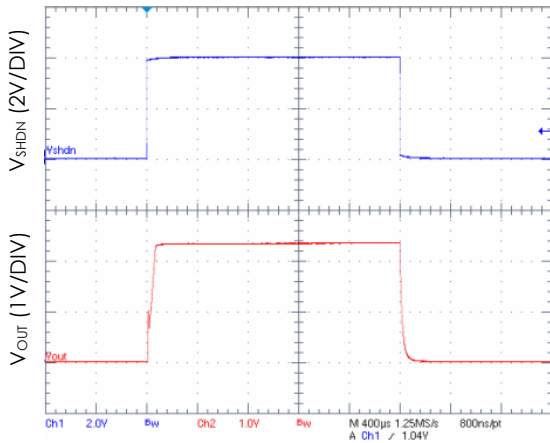

CH2 Power Down Response

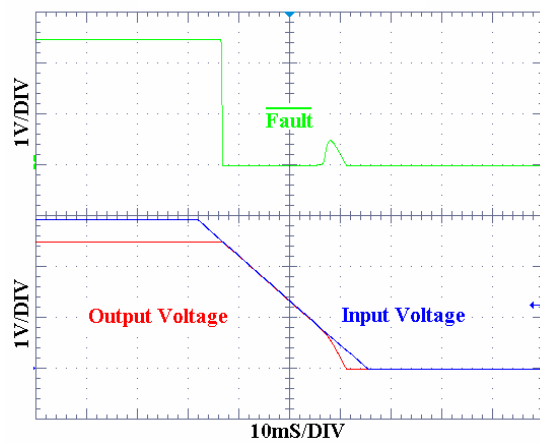

CH2 Power Up Response

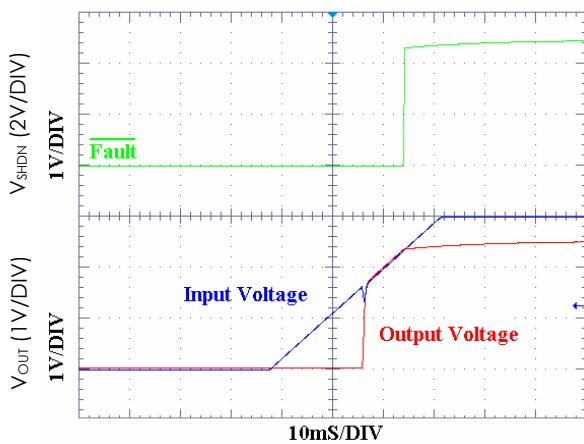

CH2 Load Transient

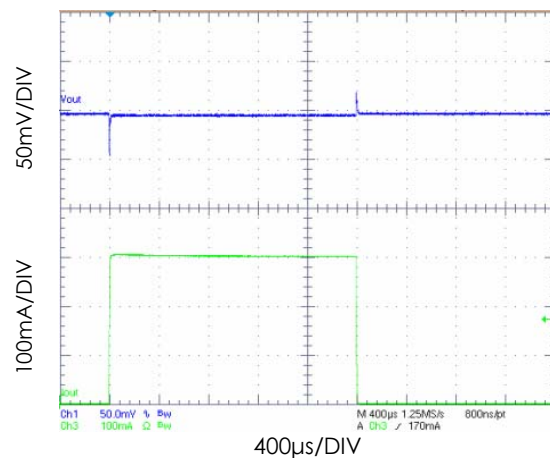

CH2 Load Transient

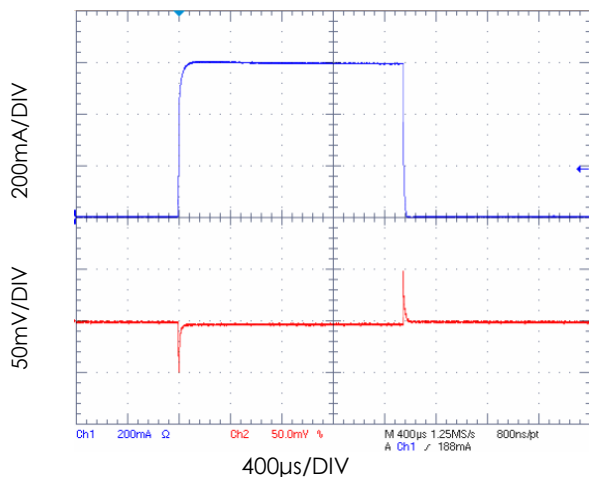

CH2 Line Transient

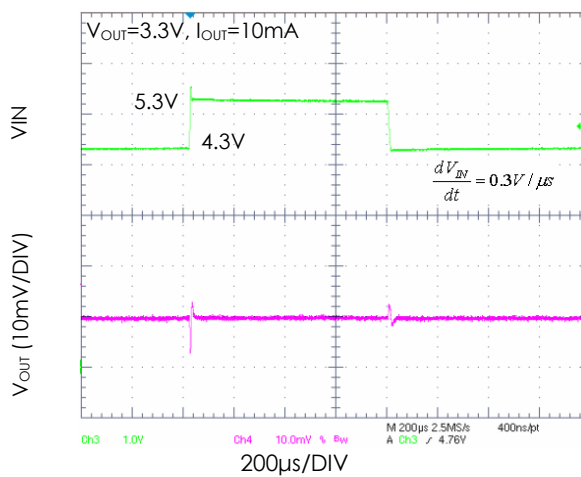

CH2 Line Transient

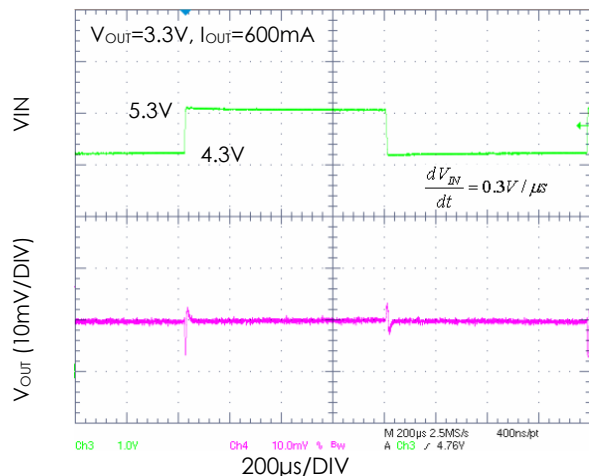

CH2 Current Limit

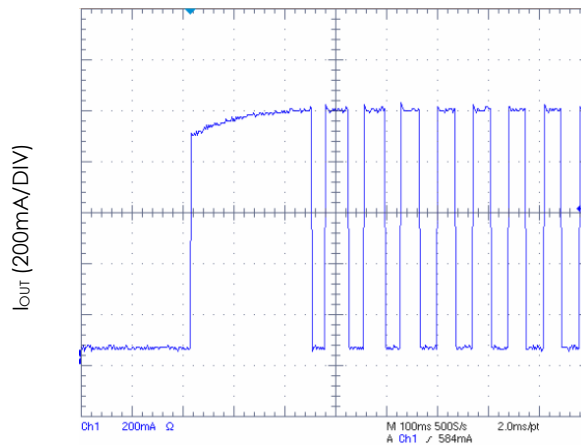

CH3/CH4 Efficiency vs Output Current

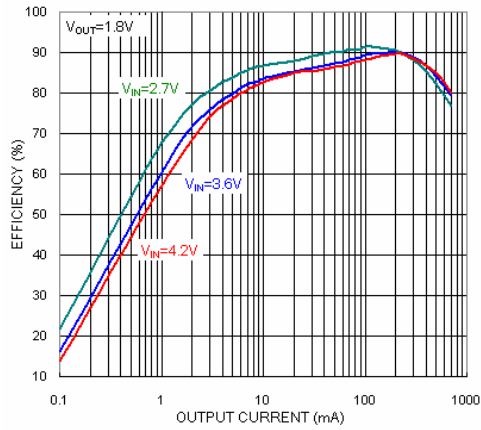

CH3/CH4 Efficiency vs Output Current

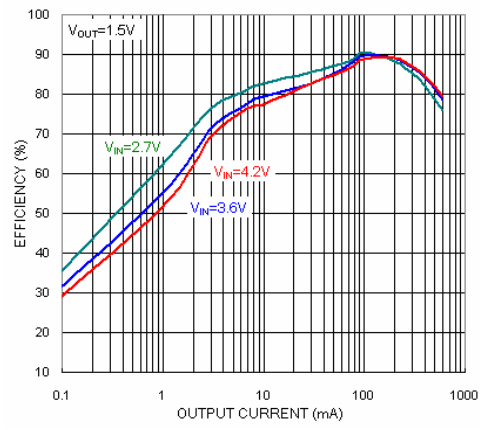

CH3/CH4 Efficiency vs Output Current

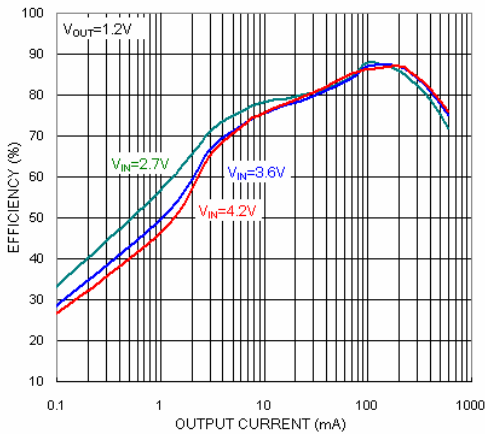

CH3/CH4 Efficiency vs Output Current

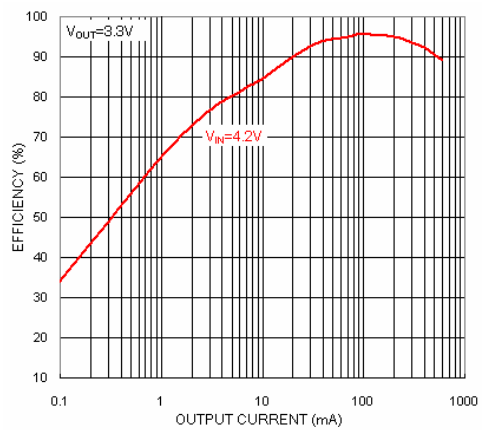

CH3/CH4 Output Voltage vs Load Current

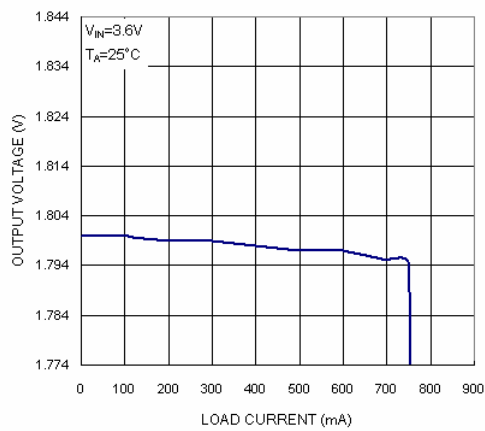

CH3/CH4 Reference voltage vs Temperature

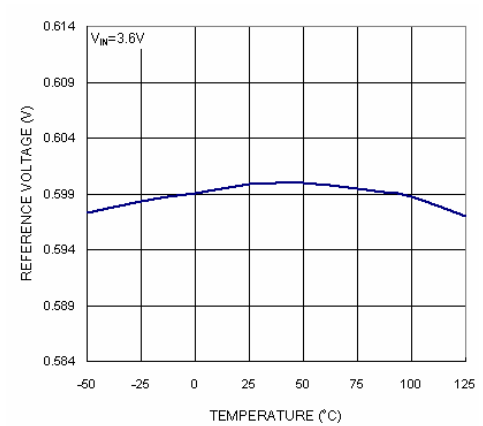



CH3/CH4  $R_{DS(ON)}$  vs Temperature

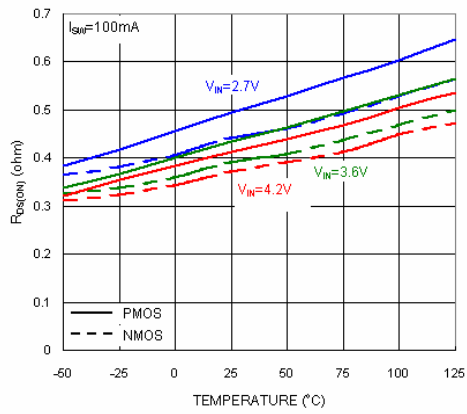

CH3/CH4  $R_{DS(ON)}$  vs Input Voltage

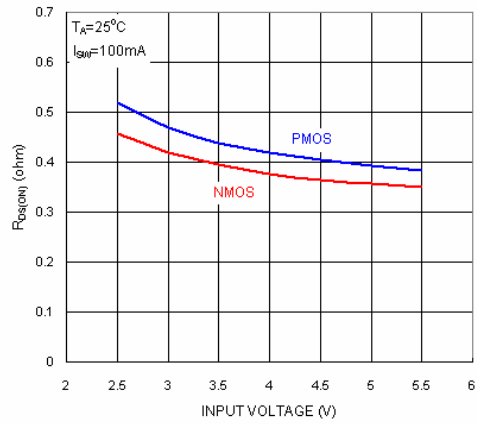

CH3/CH4 Dynamic Supply Current vs Temperature

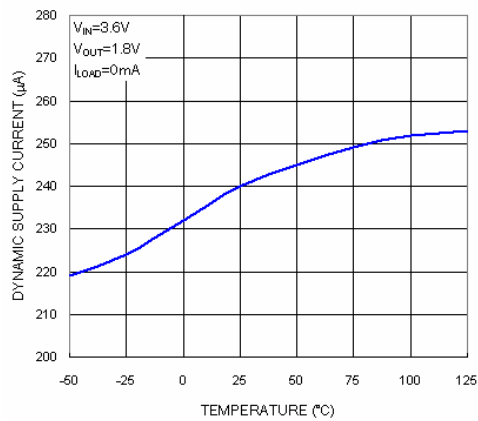

CH3/CH4 Dynamic Supply Current vs Supply Voltage

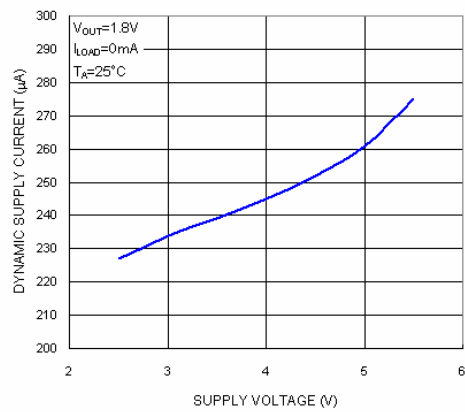

CH3/CH4 Oscillator Frequency vs Temperature

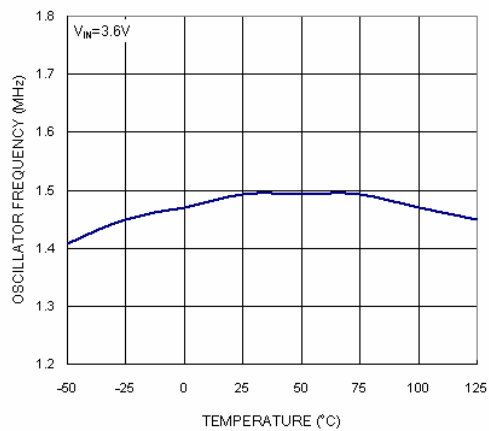

CH3/CH4 Oscillator Frequency vs Supply Voltage

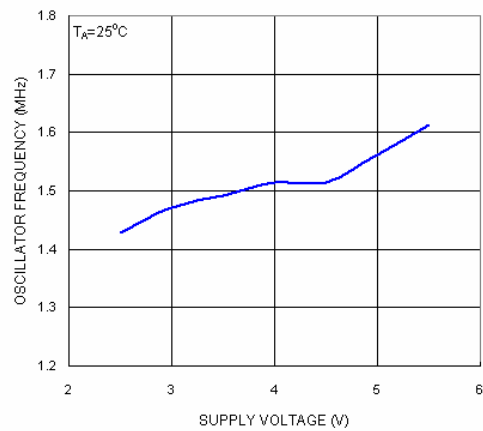

CH3/CH4 Discontinuous Operation

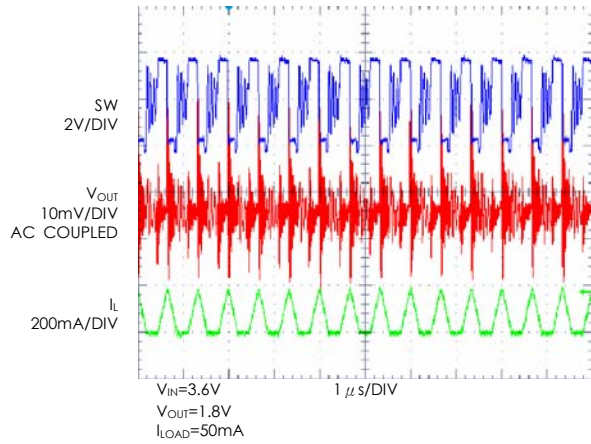

CH3/CH4 Start-up From Shutdown

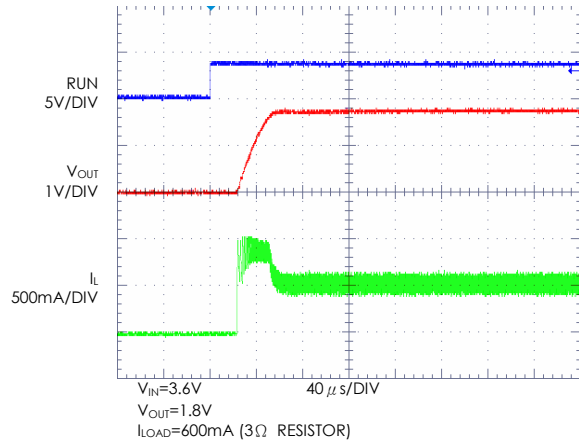

CH3/CH4 Load Step

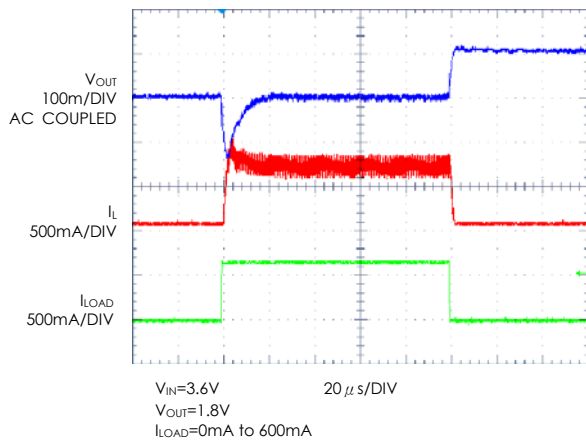

CH3/CH4 Load Step

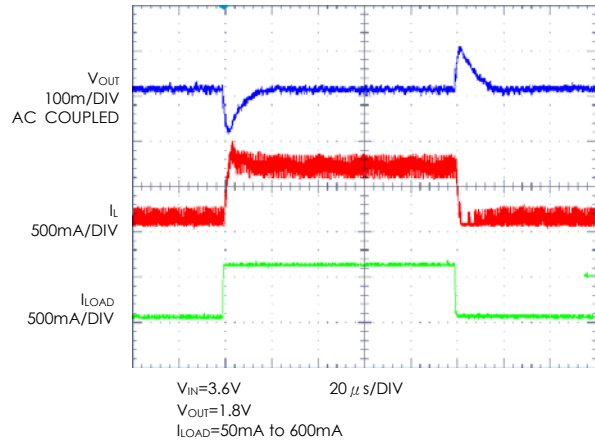

CH3/CH4 Load Step

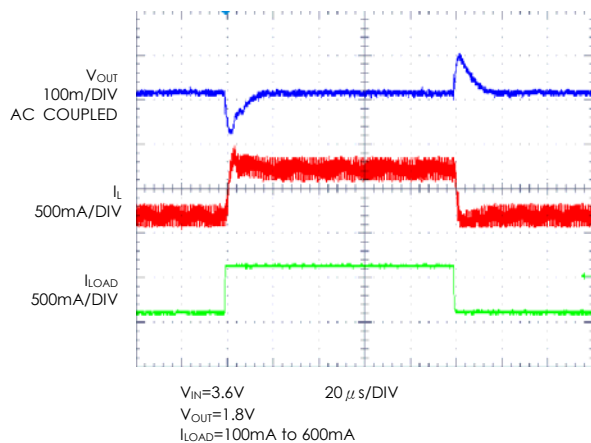

CH3/CH4 Load Step

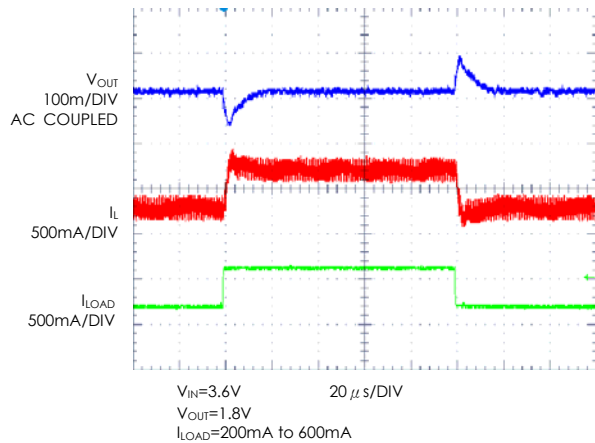

## Application Information

The EMQ8932 is a high efficiency, 4-channel power management IC for portable devices application.

The four channels are listed as following :

**CH1 : Linear charger for single cell lithium-ion battery**

**CH2 : High PSRR, low noise, low dropout 600mA LDO**

**CH3/4 : 600mA Synchronous Buck converters**

CH2/3/4 are Vout adjustable

### CH1 Linear Charger

CH1 :The Linear Charger is a complete linear charger for single cell lithium-ion battery that is specifically designed to work within USB power specifications.

No external sense resistor and blocking diode are required. Charging current can be programmed externally with a single resistor. The built-in thermal regulation facilitates charging with maximum power without risk of overheating.

The charger always preconditions the battery with 1/10 of the programmed charge current at the beginning of a charge cycle, until 40 s after it verifies that the battery can be fast-charged. The charger automatically terminates the charge cycle when the charge current drops to 1/10th the programmed value after the final float voltage is reached.

The charger can also be used as a LDO when battery is removed. Other features include reverse current protection, shutdown mode, charge current monitor, under voltage lockout, automatic recharge and status indicator.

#### ■ CH1 Programming Charging Current

The Charging current (I<sub>BAT</sub>) can be programmed up to 1.0A by equation (1).

$$I_{BAT} = (V_{PROG} / R_{PROG}) * 960 \dots \dots \dots (1)$$

### CH2 : High PSRR, low noise, low dropout 600mA LDO

The LDO adopts the classical regulator topology in

which negative feedback control is used to perform the desired voltage regulating function. The negative feedback is formed by using feedback resistors (R3, R4) to sample the output voltage (V<sub>OUT2</sub>) for the non-inverting input of the error amplifier, whose inverting input is set to the bandgap reference voltage. By virtue of its high open-loop gain, the error amplifier operates to ensure that the sampled output feedback voltage at its non-inverting input is virtually equal to the preset bandgap reference voltage.

The error amplifier compares the voltage difference at its inputs and produces an appropriate driving voltage to the P-channel MOS pass transistor to control the amount of current reaching the output. If there are changes in the output voltage due to load changes, the feedback resistors register such changes to the non-inverting input of the error amplifier. The error amplifier then adjusts its driving voltage to maintain virtual short between its two input nodes under all loading conditions. In a nutshell, the regulation of the output voltage is achieved as a direct result of the error amplifier keeping its input voltages equal. This negative feedback control topology is further augmented by the shutdown, the temperature protection and current protection circuitry.

#### ■ CH2 Output Voltage Control

The LDO allows direct user control of the output voltage in accordance with the amount of negative feedback present. To see the explicit relationship between the output voltage and the negative feedback, it is convenient to conceptualize the LDO as an ideal non-inverting operational amplifier with a fixed DC reference voltage V<sub>REF2</sub> at its non-inverting input. Such a conceptual representation of the LDO in closed-loop configuration is shown in Figure 2. This ideal op amp

features an ultra-high input resistance such that its inverting input voltage is virtually fixed at  $V_{REF2}$ . The output voltage is therefore given by:

$$V_{OUT2} = V_{REF2} \left[ \frac{R_4}{R_3} + 1 \right] \dots\dots\dots(2)$$

This equation can be rewritten in the following form to facilitate the determination of the resistor values for a chosen output voltage:

$$R_4 = R_3 \left[ \frac{V_{OUT2}}{1.19V} - 1 \right] \dots\dots\dots(3)$$

)

Set  $R_3$  equal to  $100k\ \Omega$  to optimize for overall accuracy, power supply rejection, noise, and power consumption.

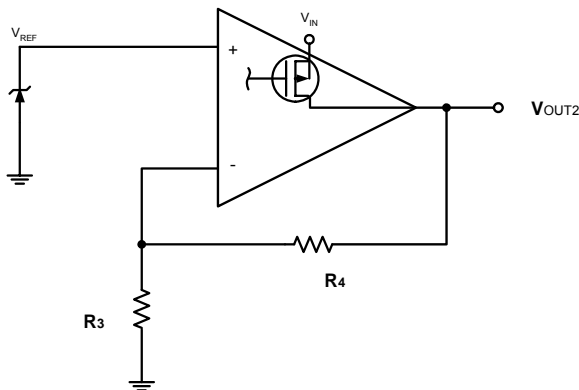

Figure 2. Simplified Regulator Topology

■ **CH2 Output Capacitor**

The LDO is specially designed for use with ceramic output capacitors of as low as  $2.2\mu F$  to take advantage of the savings in cost and space as well as the superior filtering of high frequency noise. Capacitors of higher value or other types may be used, but it is important to make sure its equivalent series resistance (ESR) be restricted to less than  $0.5\ \Omega$ . The use of larger capacitors with smaller ESR values is desirable for applications involving large and fast input or output transients, as well as for situations where the application systems are not physically located immediately adjacent to the battery power

source. Typical ceramic capacitors suitable for use with the LDO are X5R and X7R. The X5R and the X7R capacitors are able to maintain their capacitance values to within  $\pm 20\%$  and  $\pm 10\%$ , respectively, as the temperature increases.

■ **CH2 No-Load Stability**

The LDO is capable of stable operation during no-load conditions, a mandatory feature for some applications such as CMOS RAM keep-alive operations.

■ **CH2 Input Capacitor**

A minimum input capacitance of  $1\mu F$  is required for the LDO. The capacitor value may be increased without limit. Improper workbench set-ups may have adverse effects on the normal operation of the regulator. A case in point is the instability that may result from long supply lead inductance coupling to the output through the gate capacitance of the pass transistor. This will establish a pseudo LCR network, and is likely to happen under high current conditions or near dropout. A  $10\mu F$  tantalum input capacitor will dampen the parasitic LCR action thanks to its high ESR. However, cautions should be exercised to avoid regulator short-circuit damage when tantalum capacitors are used, for they are prone to fail in short-circuit operating conditions.

■ **CH2 Compensation (Noise Bypass) Capacitor**

Substantial reduction in the output voltage noise of the LDO is accomplished through the connection of the noise bypass capacitor  $C_{CC}$  ( $33nF$  optimum) between CC pin and the ground. Because CC pin connects directly to the high impedance output of the bandgap reference circuit, the level of the DC leakage currents in the  $C_{CC}$  capacitors used will adversely reduce the regulator output voltage. This sets the DC leakage level as the key selection criterion of the  $C_{CC}$  capacitor types for use with the

LDO. NPO and COG ceramic capacitors typically offer very low leakage. Although the use of the C<sub>CC</sub> capacitors does not affect the transient response, it does affect the turn-on time of the regulator. Tradeoff exists between output noise level and turn-on time when selecting this capacitor value.

■ **CH2 Power Dissipation and Thermal Shutdown**

Thermal overload results from excessive power dissipation that causes the IC junction temperature to increase beyond a safe operating level. The LDO relies on dedicated thermal shutdown circuitry to limit its total power dissipation. An IC junction temperature T<sub>J</sub> exceeding 165°C will trigger the thermal shutdown logic, turning off the P-channel MOS pass transistor. The pass transistor turns on again after the junction cools off by about 30°C. When continuous thermal overload conditions persist, this thermal shutdown action then results in a pulsed waveform at the output of the regulator. The concept of thermal resistance  $\theta_{JA}$  (°C/W) is often used to describe an IC junction's relative readiness in allowing its thermal energy to dissipate to its ambient air. An IC junction with a low thermal resistance is preferred because it is relatively effective in dissipating its thermal energy to its ambient, thus resulting in a relatively low and desirable junction temperature. The relationship between  $\theta_{JA}$  and T<sub>J</sub> is as follows:

$$T_J = \theta_{JA} (P_D) + T_A \dots\dots\dots$$

(4)

T<sub>A</sub> is the ambient temperature, and P<sub>D</sub> is the power generated by the IC and can be written as:

$$P_D = I_{OUT} (V_{IN} - V_{OUT}) \dots\dots\dots$$

(5)

As the above equations show, it is desirable to work with ICs whose  $\theta_{JA}$  values are small such that T<sub>J</sub>

does not increase strongly with P<sub>D</sub>. To avoid thermal overloading the LDO, refrain from exceeding the absolute maximum junction temperature rating of 150°C under continuous operating conditions. Overstressing the regulator with high loading currents and elevated input-to-output differential voltages can increase the IC die temperature significantly.

■ **CH2 Shutdown**

CH2 enters the sleep mode when the EN2 pin is low. When this occurs, the pass transistor, the error amplifier, and the biasing circuits, including the bandgap reference, are turned off, thus reducing the supply current to typically 1nA. Such a low supply current makes the LDO best suited for battery-powered applications. The maximum guaranteed voltage at the EN2 pin for the sleep mode to take effect is 0.4V. A minimum guaranteed voltage of 1.2V at the EN2 pin would activate the LDO. Direct connection of the EN2 pin to the V<sub>IN2</sub> to keep the regulator on is allowed for the LDO. In this case, the EN2 pin must not exceed the supply voltage V<sub>IN2</sub>.

■ **Fast Start-Up**

Fast start-up time is important for overall system efficiency improvement. The LDO assures fast start-up speed when using the optional noise bypass capacitor (C<sub>CC</sub>). To shorten start-up time, the LDO internally supplies a 500µA current to charge up the capacitor until it reaches about 90% of its final value.

**CH3/4 : 600mA Synchronous Buck converters**

The typical application circuit of the current mode DC/DC converters is shown in Fig.4.

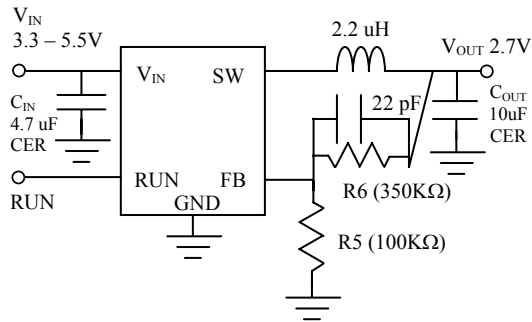

Fig. 3

■ CH3/4 Inductor Selection

Basically, inductor ripple current and core saturation are two factors considered to decide the Inductor value.

$$\Delta I_L = \frac{1}{f \cdot L} V_{OUT} \left( 1 - \frac{V_{OUT}}{V_{IN}} \right) \dots\dots\dots (6)$$

The Eq. 6 shows the inductor ripple current is a function of frequency, inductance, VIN (VIN3, VIN4) and VOUT (VOUT3, VOUT4). It is recommended to set ripple current to 40% of max. load current. A low DCR inductor is preferred.

■ CH3/4 CIN and COUT Selection

A low ESR input capacitor can prevent large voltage transients at VIN (VIN3, VIN4). The RMS current of input capacitor is required larger than IRMS calculated by:

$$I_{RMS} \cong I_{OMAX} \frac{\sqrt{V_{OUT}(V_{IN} - V_{OUT})}}{V_{IN}} \dots\dots\dots (7)$$

ESR is an important parameter to select COUT (COUT3, COUT4). The output ripple ΔVOUT (ΔVOUT3, ΔVOUT4) is determined by:

$$\Delta V_{OUT} \cong \Delta I_L \left( ESR + \frac{1}{8 \cdot f \cdot C_{OUT}} \right) \dots\dots\dots (8)$$

Higher values, lower cost ceramic capacitors are now available in smaller sizes. These ceramic capacitors have high ripple currents, high voltage ratings and low ESR that make them ideal for switching regulator applications. Optimize very low

output ripple and small circuit size is doable from COUT selection since COUT does not affect the internal control loop stability. It is recommended to use the X5R or X7R which have the best temperature and voltage characteristics of all the ceramics for a given value and size.

■ CH3/4 Output Voltage (VOUT3, VOUT4)

The output voltage can be determined by following equation:

$$V_{OUT} = 0.6V \left( 1 + \frac{R_6}{R_5} \right) \dots\dots\dots (9)$$

CH3 Case, Replace R5 as R7, R6 as R8 in CH4 case.

■ CH3/4 Thermal Considerations

Although thermal shutdown is build-in in the step-down DC/DC converter(s) that protects the device from thermal damage, the total power dissipation that the converter(s) can sustain should be base on the package thermal capability. The formula to ensure the safe operation is shown in Note 3.

To avoid the DC/DC converter(s) from exceeding the maximum junction temperature, the user will need to do some thermal analysis.

■ CH3/4 Guidelines for PCB Layout

To ensure proper operation of the DC/DC converter(s) , please note the following PCB layout guidelines:

1. The GND trace, the SW (SW3, SW4) trace and the VIN (VIN3, VIN4) trace should be kept short, direct and wide.
2. VFB (FB3, FB4) pin must be connected directly to the feedback resistors. Resistive divider R5/R6 (CH3); R7/R8 (CH4) must be connected and parallel to the output capacitor COUT (COUT3, COUT4).
3. The Input capacitor CIN (CIN3, CIN4) must be

connected to pin  $V_{IN}$  ( $V_{IN3}$ ,  $V_{IN4}$ ) as closely as possible.

4. Keep SW (SW3, SW4) node away from the sensitive  $V_{FB}$  (FB3, FB4) node since this node is with high frequency and voltage swing.
5. Keep the (-) plates of  $C_{IN}$  ( $C_{IN3}$ ,  $C_{IN4}$ ) and  $C_{OUT}$  ( $C_{OUT3}$ ,  $C_{OUT4}$ ) as close as possible.

■ **CH3/4 Design Example**

Assume the Step-down DC/DC converter(s) is (are) used in a single lithium-ion battery-powered application. The  $V_{IN}$  ( $V_{IN3}$ ,  $V_{IN4}$ ) range will be about 2.7V to 4.2V. Output voltage ( $V_{OUT3}$ ,  $V_{OUT4}$ ) is 1.8V.

With this information we can calculate L using equation:

$$L = \frac{1}{f \cdot \Delta I_L} V_{OUT} \left( 1 - \frac{V_{OUT}}{V_{IN}} \right) \dots\dots\dots(10)$$

Substituting  $V_{OUT} = 1.8V$ ,  $V_{IN} = 4.2V$ ,  $I_L = 240mA$  and  $f = 1.5MHz$  in eq. 10 gives:

$$L = \frac{1.8V}{1.5MHz \cdot 240mA} \left( 1 - \frac{1.8V}{4.2V} \right) = 2.86\mu H \dots\dots\dots(11)$$

A 2.2 $\mu H$  inductor could be chose with this application.

A greater inductor with less equivalent series resistance makes best efficiency.  $C_{IN}$  ( $C_{IN3}$ ,  $C_{IN4}$ ) will require an RMS current rating of at least  $I_{LOAD(MAX)}/2$  and low ESR. In most cases, a ceramic capacitor will satisfy this requirement.

TQFN-24 4x4x0.75mm Outline Dimension

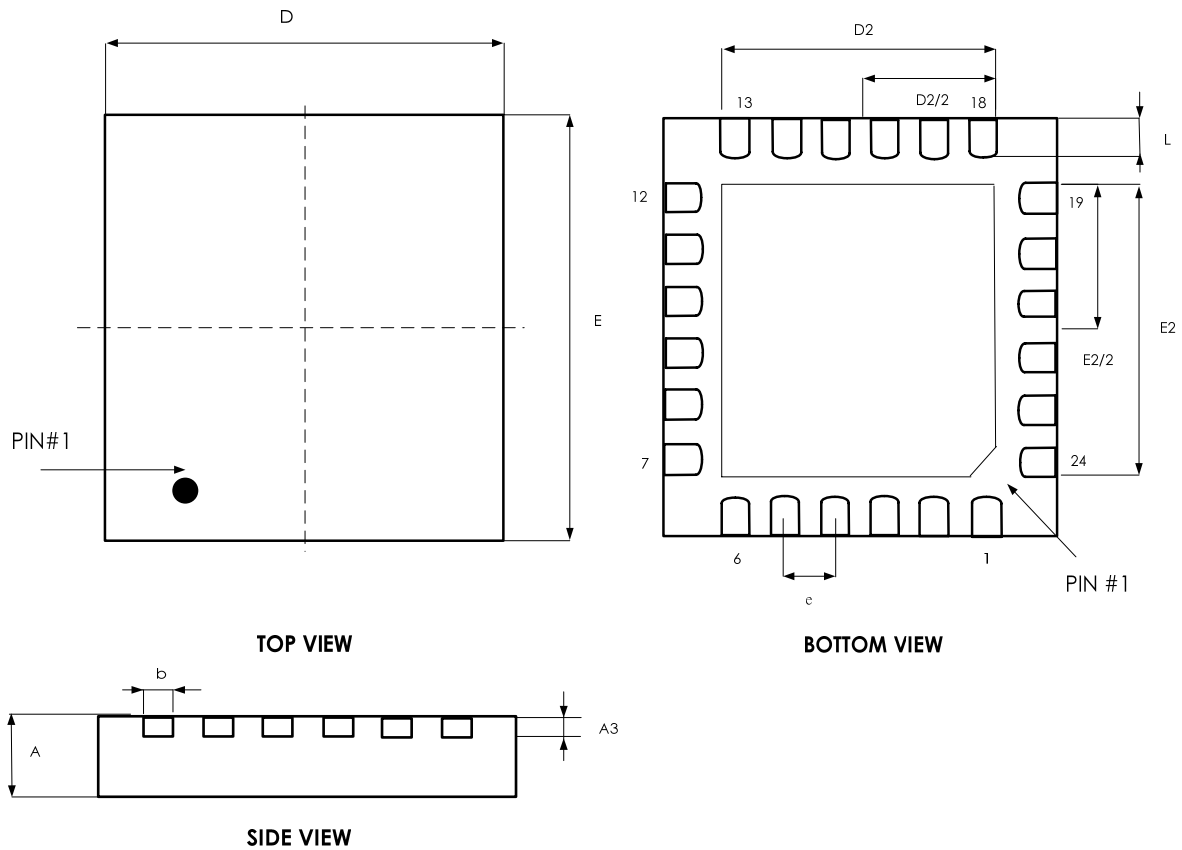

| SYMBOL | COMMON                |           |           |                 |             |             |
|--------|-----------------------|-----------|-----------|-----------------|-------------|-------------|
|        | DIMENSIONS MILLIMETER |           |           | DIMENSIONS INCH |             |             |
|        | MIN.                  | NOM.      | MAX.      | MIN.            | NOM.        | MAX.        |
| A      | 0.700                 | 0.750     | 0.800     | 0.027           | 0.029       | 0.031       |
| A3     | 0.195                 | 0.203     | 0.211     | 0.0077          | 0.0080      | 0.0083      |
| b      | 0.180                 | 0.230     | 0.300     | 0.007           | 0.009       | 0.012       |
| D      | 3.925                 | 4.000     | 4.075     | 0.154           | 0.157       | 0.160       |
| E      | 3.925                 | 4.000     | 4.075     | 0.154           | 0.157       | 0.160       |
| e      | 0.50 BSC              |           |           | 0.020 BSC       |             |             |
| L      | 0.300                 | 0.350     | 0.400     | 0.012           | 0.014       | 0.016       |
| D2/E2  | 2.50/2.50             | 2.65/2.65 | 2.80/2.80 | 0.098/0.098     | 0.104/0.104 | 0.110/0.110 |



**Revision History**

| <b>Revision</b> | <b>Date</b> | <b>Description</b>                              |
|-----------------|-------------|---|
| 1.0             | 2008.05.30  | Original  |
| 1.1             | 2008.12.08  | Correct pin order of MCHRG and SHDN2 in page 4. |
| 1.2             | 2009.05.26  | Modify order information                        |
| 1.3             | 2010.10.13  | Modify packing quantity for tape and reel       |

**Important Notice**

All rights reserved.

No part of this document may be reproduced or duplicated in any form or by any means without the prior permission of ESMT.

The contents contained in this document are believed to be accurate at the time of publication. ESMT assumes no responsibility for any error in this document, and reserves the right to change the products or specification in this document without notice.

The information contained herein is presented only as a guide or examples for the application of our products. No responsibility is assumed by ESMT for any infringement of patents, copyrights, or other intellectual property rights of third parties which may result from its use. No license, either express, implied or otherwise, is granted under any patents, copyrights or other intellectual property rights of ESMT or others.

Any semiconductor devices may have inherently a certain rate of failure. To minimize risks associated with customer's application, adequate design and operating safeguards against injury, damage, or loss from such failure, should be provided by the customer when making application designs.

ESMT's products are not authorized for use in critical applications such as, but not limited to, life support devices or system, where failure or abnormal operation may directly affect human lives or cause physical injury or property damage. If products described here are to be used for such kinds of application, purchaser must do its own quality assurance testing appropriate to such applications.