

1.5MHz, 1A Synchronous Step-Down Converter with Soft Start

DESCRIPTION

The EUP3080 is a constant frequency, current mode, PWM step-down converter. The device integrates a main switch and a synchronous rectifier for high efficiency. The 2.5V to 5.5V input voltage range makes the EUP3080 ideal for powering portable equipment that runs from a single cell Lithium-Ion (Li+) battery or 3-cell NiMH/ NiCd batteries. The output voltage can be regulated as low as 0.6V. The EUP3080 supports up to 1A load current and can also run at 100% duty cycle for low dropout applications, extending battery life in portable systems.

Switching frequency is internally set at 1.5MHz, allowing the use of small surface mount inductors and capacitors. The internal synchronous switch increases efficiency while eliminates the need for an external Schottky diode. The EUP3080 is available in TDFN-6 and SOT23-5 Packages.

FEATURES

- High Efficiency up to 96%
- Low $R_{DS(ON)}$ for internal switches:
High-side:280mΩ
Low-side:200mΩ
- 1.5MHz Constant Switching Frequency
- 1A Available Load Current
- 90μA Typical Quiescent Current
- 2.5V to 5.5V Input Voltage Range
- Adjustable Output Voltage as Low as 0.6V
- 100% Duty Cycle Low Dropout Operation
- Short Circuit and Thermal Protection
- Soft Start Function
- Over Voltage Protection
- Available in TDFN-6 and SOT23-5 Packages
- RoHS Compliant and 100% Lead(Pb)-Free Halogen-Free

APPLICATIONS

- Cellular and Smart Phones
- Portable Media Players/ MP3 Players
- Digital Still and Video Cameras
- Portable Instruments
- WLAN PC Cards

Typical Application Circuit

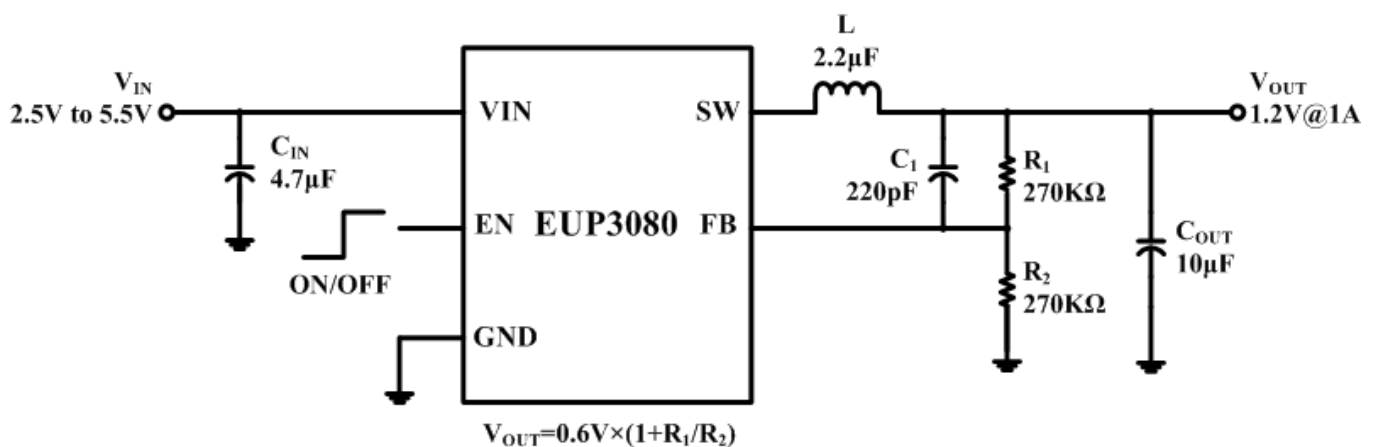

Figure 1. Application Circuit