

3A, 30V, 500KHz Step-Down Converter

DESCRIPTION

The EUP3451 is current mode, step-down switching regulator capable of driving 3A continuous load with excellent line and load regulation. The EUP3451 can operate with an input voltage range from 4.5V to 30V and the output can be externally set from 0.8V to 12V with a resistor divider.

Fault condition protection includes cycle-by-cycle current limiting and thermal shutdown. In shutdown mode the regulator draws 1 μ A of supply current. Programmable soft-start minimizes the inrush supply current and the output overshoot at initial startup.

The EUP3451 require a minimum number of external components.

FEATURES

- 35V Input Surge Protection
- 3A Output Current
- 0.135 Internal DMOS Output Switch
- 4.5V to 30V Input Operating Range
- Output Adjustable from 0.8V to 12V
- Up to 95% Efficiency
- 1 μ A Shutdown Current
- Fixed 500KHz Frequency
- Thermal Shutdown and Overcurrent Protection
- Input Supply Overvoltage and Undervoltage Lockout
- Available SOP-8 Package
- RoHS Compliant and 100% Lead(Pb)-Free

APPLICATIONS

- PC Monitors
- Distributed Power Systems
- Networking Systems
- Portable Electronics

Typical Application Circuit

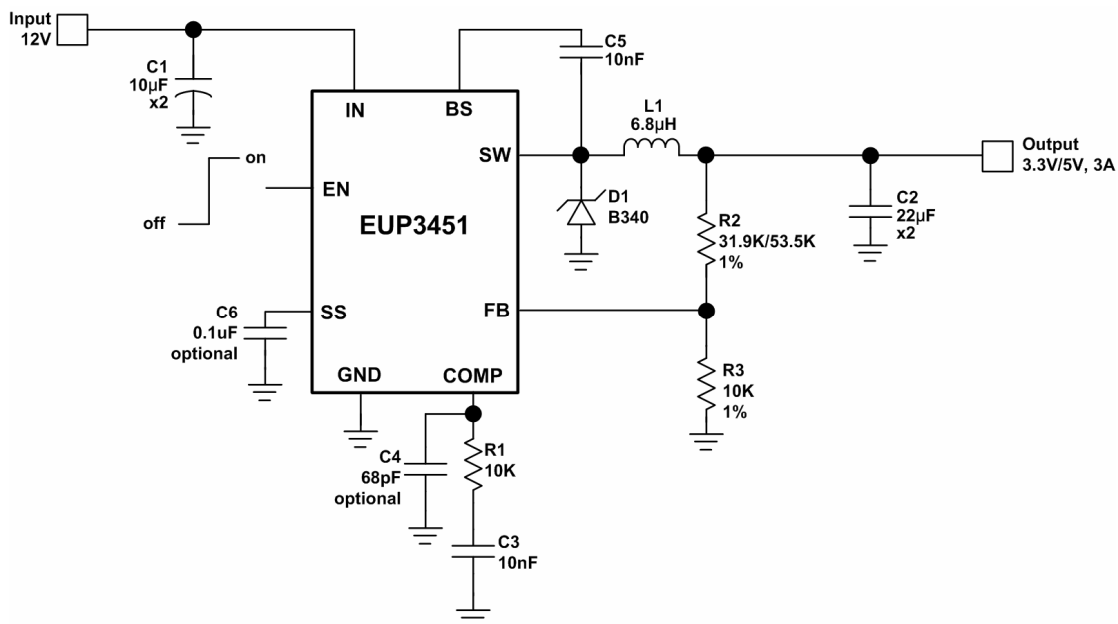

Figure 1. 12V to 3.3V/5V Application Circuit

Typical Application Circuit (continued)

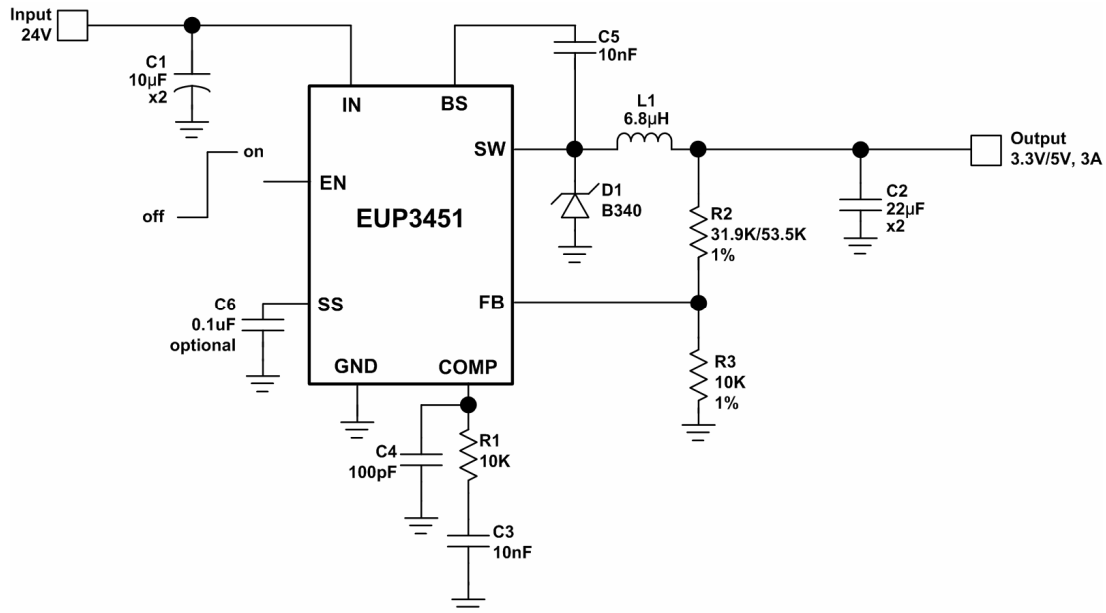

Figure 2. 24V to 3.3V/5V Application Circuit

Pin Configurations

Package Type	Pin Configurations
SOP-8	<p>(Top View)</p>

Pin Description

Pin Name	SOP-8	DESCRIPTION
BS	1	High-Side Gate Driver Bootstrap Supply. BS provides power to the gate driver of high-side n-channel MOSFET switch. Connect a 10nF or greater capacitor from SW to BS.
IN	2	Input Supply Pin. IN supplies the power to the IC and the high side power switch. Connect IN to a 4.5V to 30V power source. Bypass IN to GND with a suitably large value capacitor to minimize input ripple to the IC. <i>See Input Capacitor Section of the applications notes.</i>
SW	3	Power Switcher Output. Connect the output LC filter from SW to the output.
GND	4	Ground.
FB	5	Output Feedback Input. FB senses the output voltage to regulate that voltage. Connect FB to an external resistor divider to set the output voltage. The feedback threshold is 0.788V. <i>See Setting the Output Voltage.</i>
COMP	6	Loop compensation pin. Connect a series RC network from COMP to GND to compensate the regulation control loop. <i>See Compensation.</i>
EN	7	Enable Input. EN is a logic input that controls the regulator on or off. Drive EN logic high to turn on the regulator, and set EN logic low to turn it off. Don't leave EN pin floating. Directly connect EN to IN (or through a resistance) for automatic startup.
SS	8	Soft-start. Connect SS to an external capacitor to program the soft-start. If unused, leave it open, which means internal soft-start function.

Ordering Information

Order Number	Package Type	Marking	Operating Temperature Range
EUP3451DIR1	SOP-8	XXXXX P3451	-40°C to +85°C

EUP3451

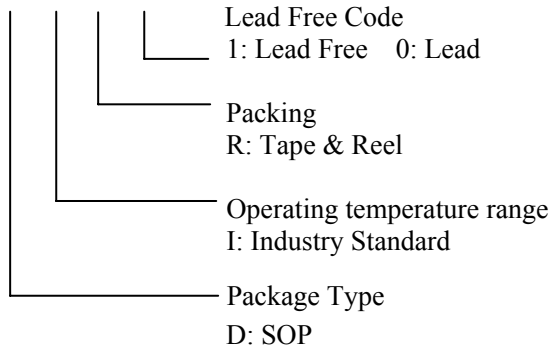

Block Diagram

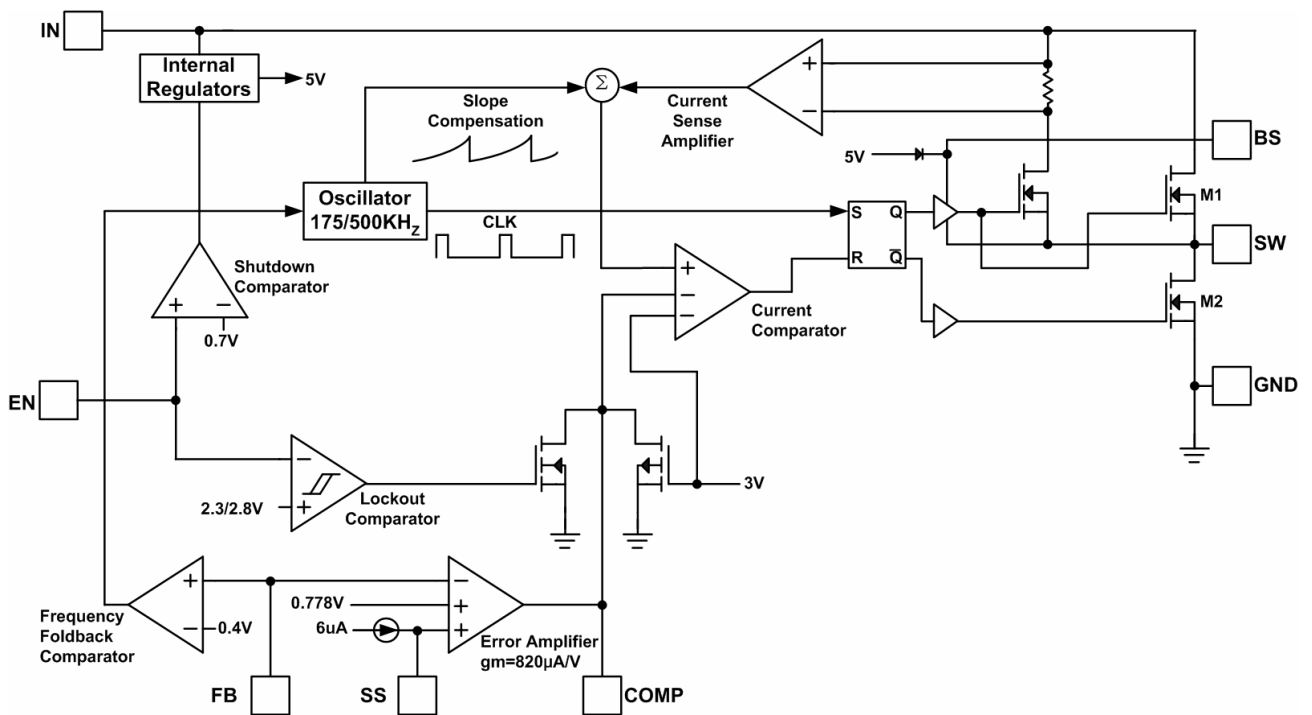

Figure 3. Functional Block Diagram

Absolute Maximum Ratings (1)

- Input Voltage (V_{IN}) ----- -0.3V to 35V
- Enable Input (V_{EN}) ----- -0.3V to 35V
- Switch Voltage (V_{SW}) ----- -1V to $V_{IN}+0.3V$
- Boot Strap Voltage (V_{BS}) ----- $V_{SW}-0.3V$ to $V_{SW}+6V$
- All Other Pins ----- -0.3V to 6V
- Junction Temperature ----- 150°C
- Storage Temperature ----- -65°C to +150°C
- Lead Temp (Soldering, 10sec) ----- 260°C
- Thermal Resistance J_A (SOP-8) ----- 55.14°C/W

Recommend Operating Conditions (2)

- Supply Voltage (V_{IN}) ----- 4.5V to 30V
- Operating Temperature Range ----- -40°C to +85°C

Note (1): Stress beyond those listed under “Absolute Maximum Ratings” may damage the device.

Note (2): The device is not guaranteed to function outside the recommended operating conditions.

Electrical Characteristics

The denote specifications which apply over the full operating temperature range, otherwise specifications are $T_A=+25^\circ\text{C}$. $V_{EN}=5V$, $V_{IN}=12V$ unless otherwise specified.

Parameter	Conditions	EUP3451			Unit
		Min	Typ	Max	
Feedback Voltage	$4.5V \leq V_{IN} \leq 30V$	0.772	0.788	0.804	V
		0.764	0.788	0.812	
Shutdown Supply Current	$V_{EN}=0V$		1	5	μA
Operating Supply Current	$V_{FB}=1V$		0.45	0.9	mA
Upper Switch On Resistance			0.135		Ω
Lower Switch On Resistance			5.6		Ω
Upper Switch Leakage	$V_{EN}=0V$, $V_{SW}=0V$			5	μA
Switch Peak Current Limit		3.6	5		A
Oscillator Frequency		425	500	575	KHz
Short Circuit Frequency	$V_{FB}=0V$		175		KHz
Maximum Duty Cycle	$V_{FB}=0.7V$		90		%
Minimum Duty Cycle	$V_{FB}=1V$			0	%
Enable Threshold		0.62	1.1	1.52	V
		0.36	1.1	1.76	
Enable Lockout Threshold	EN Rising	2.3	2.5	2.8	V
		2	2.5	3	
Enable Lockout Threshold Hysteresis			120		mV
Input Undervoltage Lockout Threshold	In Rising	3.8	4.1	4.4	V
Input Overvoltage Lockout Threshold	In Rising		35		V
Input Overvoltage Lockout Threshold Hysteresis			2		V
Soft-start Supply Current	$V_{SS}=0V$		6		μA
Enable Leakage Current	$V_{EN}=0V$		0.1	5	μA
Current Sense Transconductance			5		A/V
Output Current to Comp Pin Voltage			400		V/V
Error Amplifier Voltage Gain			820		$\mu\text{A}/V$
Error Amplifier Transconductance	$\Delta I_C = \pm 10\mu\text{A}$				$^\circ\text{C}$
Thermal Shutdown			160		

Typical Operating Characteristics

See Figure1, C1 =10uF*2, C2=22uF*2, L=6.8uH, T_A=+25°C.

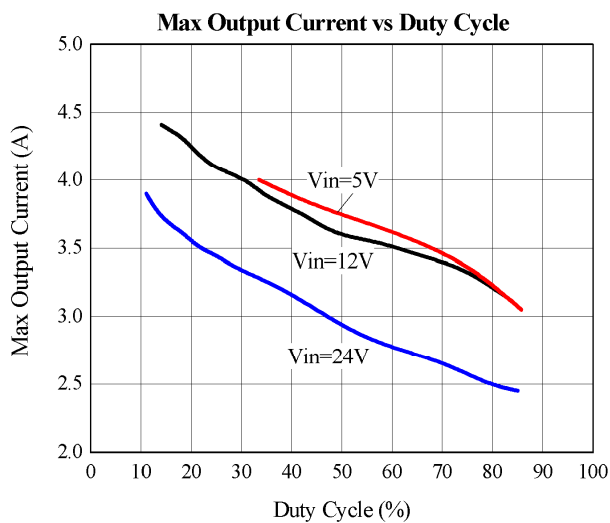
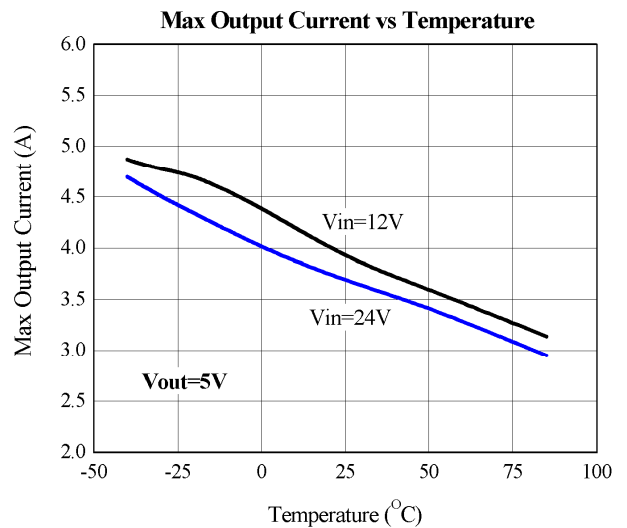
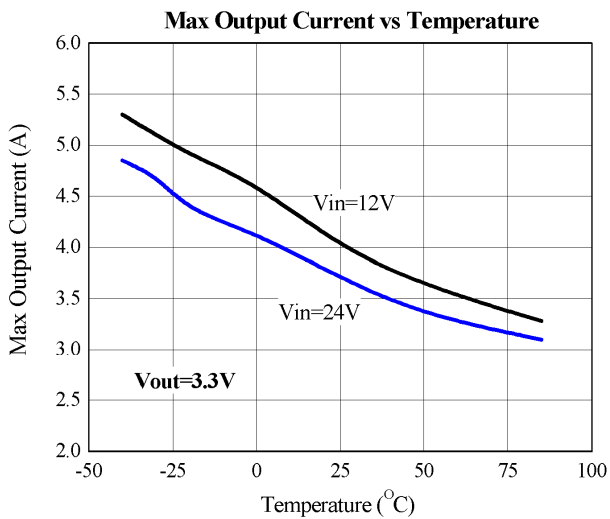
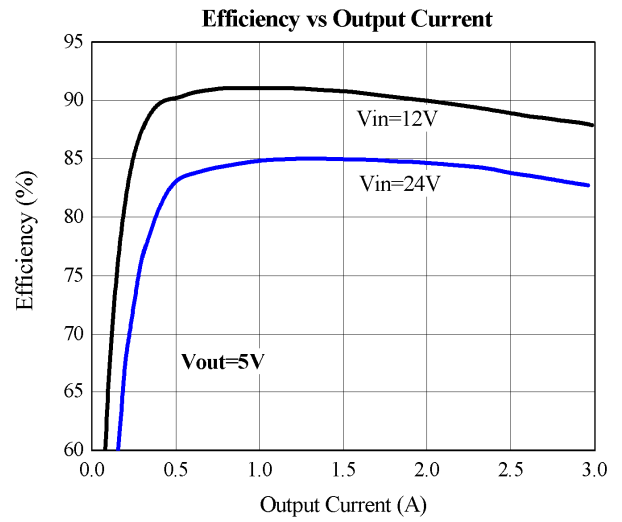
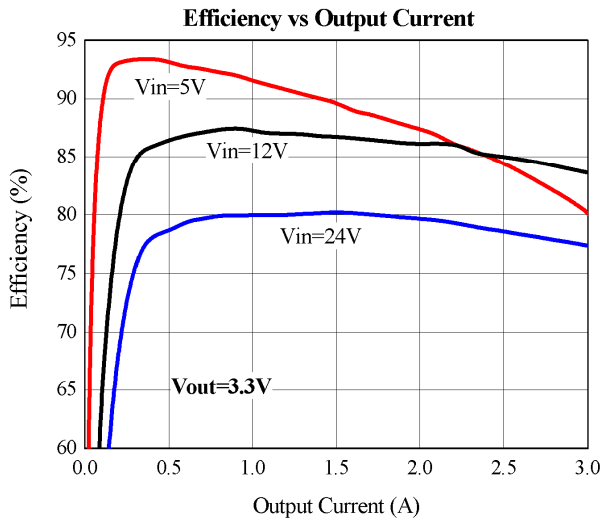

Typical Operating Characteristics (continued)

See Figure1, C1 =10uF*2, C2=22uF*2, L=6.8uH, T_A=+25°C.

Steady State Test Waveforms

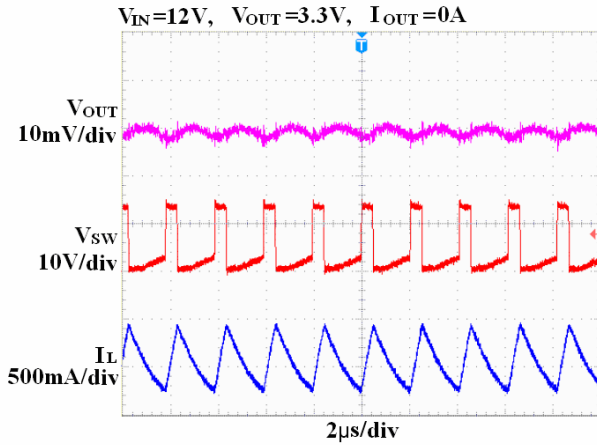

Steady State Test Waveforms

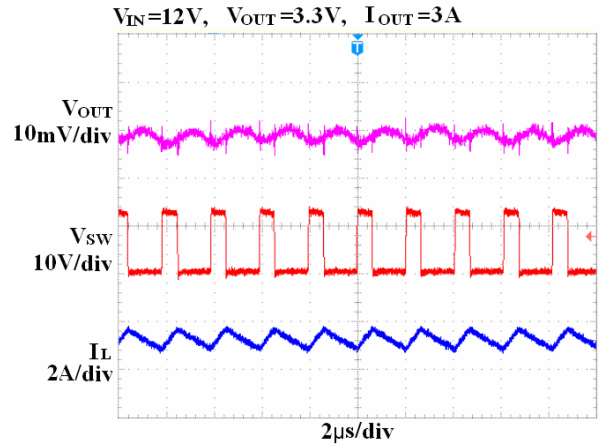

Internal Startup through Enable Waveforms

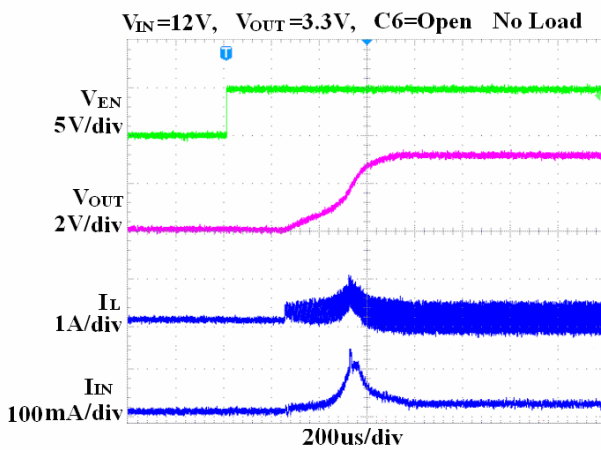

Internal Startup through Enable Waveforms

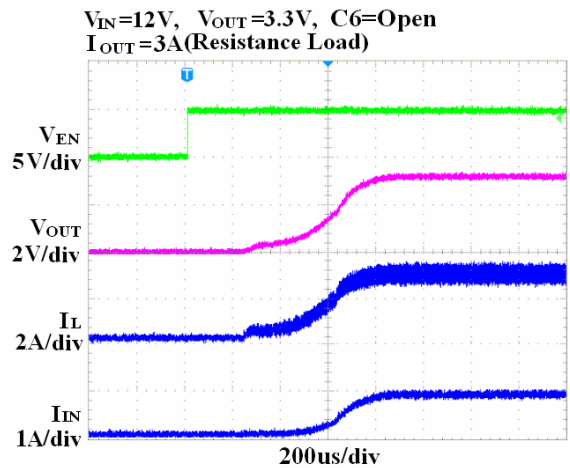

External Startup through Enable Waveforms

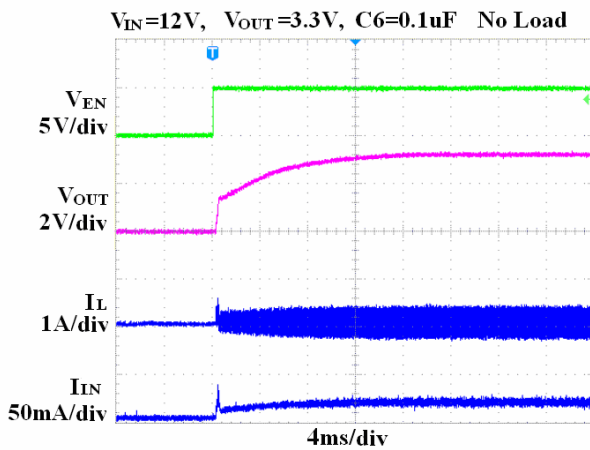

External Startup through Enable Waveforms

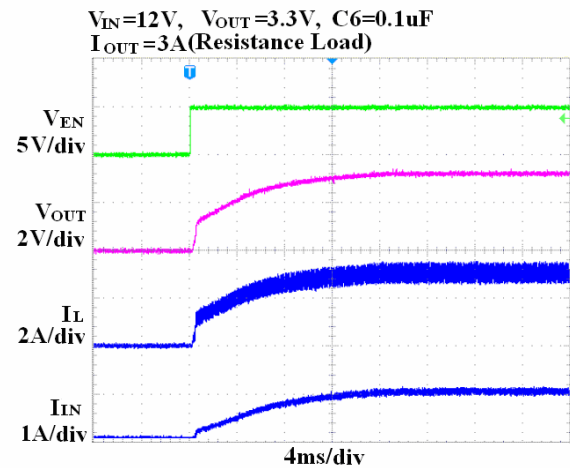

Typical Operating Characteristics (continued)

See Figure1, C1 =10uF*2, C2=22uF*2, L=6.8uH, T_A=+25°C.

Shutdown through Enable Waveforms

V_{IN}=12V, V_{OUT}=3.3V, No Load

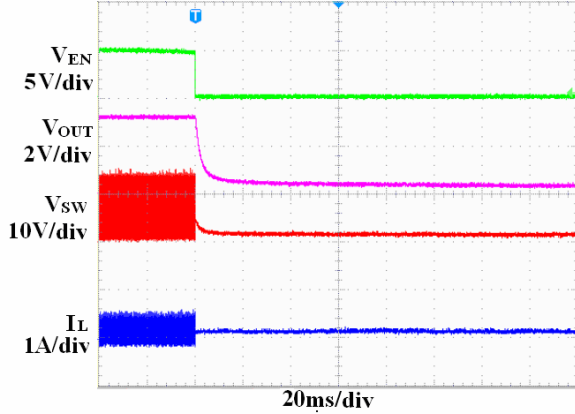

Shutdown through Enable Waveforms

V_{IN}=12V, V_{OUT}=3.3V, I_{OUT}=3A(Resistance Load)

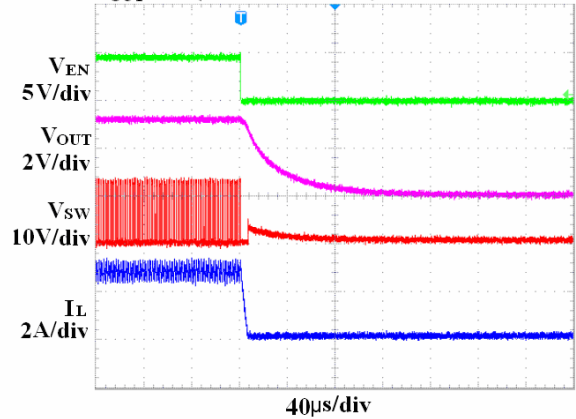

Load Transient Test Waveforms

V_{IN}=12V, V_{OUT}=3.3V, I_{OUT}=1A to 2A step

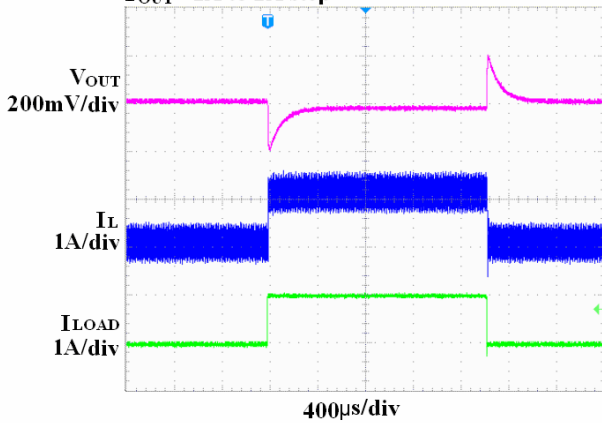

Load Transient Test Waveforms

V_{IN}=12V, V_{OUT}=3.3V, I_{OUT}=0.5A to 2.5A step

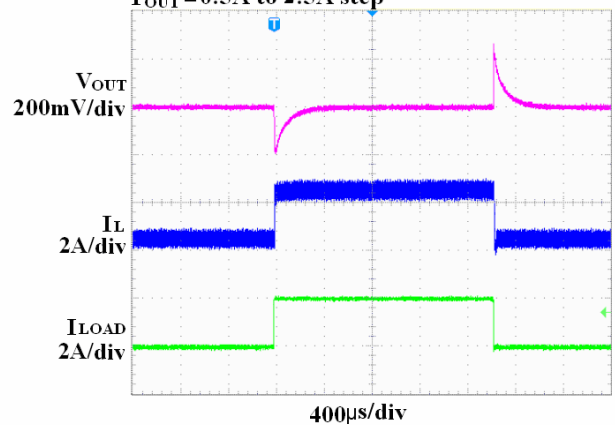

Short Circuit Test Waveforms

V_{IN}=12V, V_{OUT}=3.3V, I_{OUT}=0A

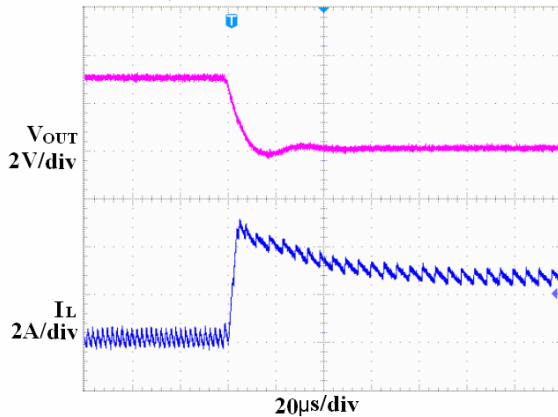

Short Circuit Recovery Waveforms

V_{IN}=12V, V_{OUT}=3.3V, I_{OUT}=0A

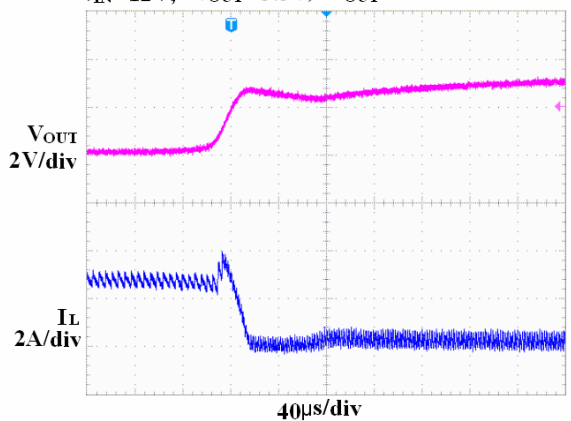

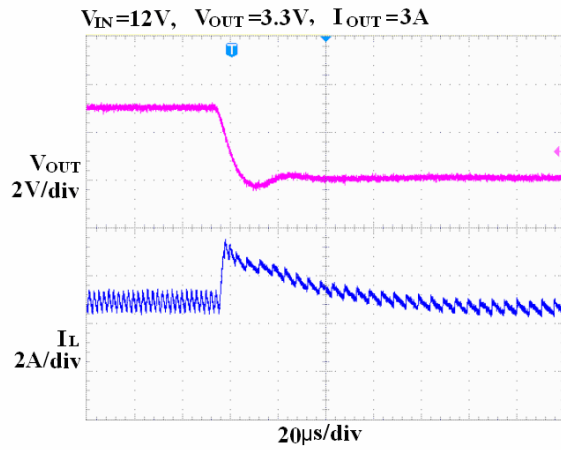
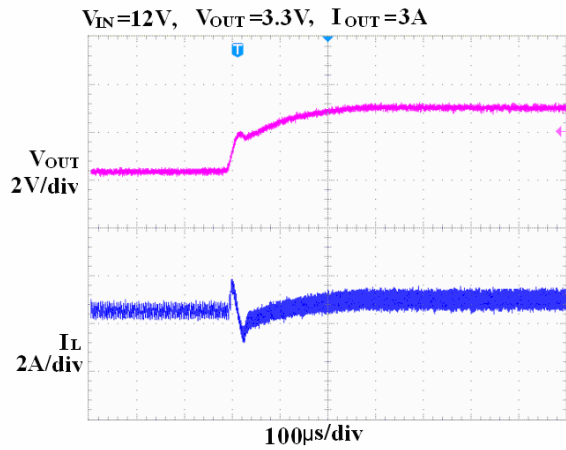
Typical Operating Characteristics (continued)See Figure1, C1 =10uF*2, C2=22uF*2, L=6.8uH, T_A=+25°C.**Short Circuit Test
Waveforms****Short Circuit Recovery
Waveforms**

Functional Description

The EUP3451 is current-mode step-down switching regulator. The device regulates an output voltage as low as 0.8V from a 4.5V to 30V input power supply. The device can provide up to 3Amp continuous current to the output. The EUP3451 uses current-mode architecture to control the regulator loop. The output voltage is measured at FB through a resistive voltage divider and amplified through the internal error amplifier. The output current of the transconductance error amplifier is presented at COMP pin where a RC network compensates the regulator loop. Slope compensation is internally added to eliminate subharmonic oscillation at high duty cycle. The slope compensation adds voltage ramp to the inductor current signal which reduces maximum inductor peak current at high duty cycles.

The device uses an internal Hside n-channel switch to step down the input voltage to the regulated output voltage. Since the Hside n-channel switch requires gate voltage greater than the input voltage, a bootstrap BS capacitor is connected between SW and BS to drive the n-channel gate. The BS capacitor is internally charged while the switch is off. An internal 5.6Ω switch from SW to GND is added to insure that SW is pulled to GND when the switch is off to fully charge the BS capacitor.

Application Information

Setting the Output Voltage

The output voltage is set through a resistive voltage divider (see Figure1 or 2). The voltage divider divides the output voltage down by the ratio:

$$V_{FB} = V_{OUT} * R3 / (R2 + R3) = 0.788V$$

Thus the output voltage is :

$$V_{OUT} = 0.788V * (R2 + R3) / R3$$

Choose R3 value in the range 10k to 100k, R2 is determined by :

$$R2 = (V_{OUT} / 0.788 - 1) * R3$$

For example, for a 3.3V output voltage, R3 is 10KΩ, and R2 is 31.9KΩ.

Inductor

The inductor is required to supply constant current to the output load while being driven by the switched input voltage. A larger value inductor results in less ripple current and lower output ripple voltage. However, the larger value inductor has a larger physical size, higher series resistance, and lower saturation current. Choose an inductor that does not saturate under the worst-case load conditions. A good rule for determining the inductance is to allow the peak-to-peak ripple current in the inductor to be approximately 30% of the maximum load current. Also, make sure that the peak inductor current (the load current plus half the peak-to-peak

inductor ripple current) is below the 3.6A minimum peak current limit.

The inductance value can be calculated by the equation:

$$L = (V_{OUT}) * (V_{IN} - V_{OUT}) / (V_{IN} * f * \Delta I)$$

Where V_{OUT} is the output voltage, V_{IN} is the input voltage, f is the switching frequency, and ΔI is the peak-to-peak inductor ripple current.

Input Capacitor

The input current to the step-down converter is discontinuous, and therefore an input capacitor C1 is required to supply the AC current to the step-down converter while maintaining the DC input voltage. A low ESR capacitor is required to keep the noise minimum at the IC. Ceramic capacitors are preferred, but tantalum or low-ESR electrolytic capacitors may also suffice. The input capacitor value should be greater than 10μF, and the RMS current rating should be greater than approximately 1/2 of the DC load current. In Figure 1 or 2, all ceramic capacitors should be placed close to the EUP3451.

Output Capacitor

The output capacitor is required to maintain the DC output voltage. Low ESR capacitors are preferred to keep the output voltage ripple low. The characteristics of the output capacitor also affect the stability of the regulator control loop. In the case of ceramic capacitors, the impedance at the switching frequency is dominated by the capacitance. The output voltage ripple is estimated to be:

$$V_{RIPPLE} \sim 1.4 * V_{IN} * (f_{LC} / f)^2$$

Where V_{RIPPLE} is the output ripple voltage, V_{IN} is the input voltage, f_{LC} is the resonant frequency of the LC filter, f is the switching frequency.

Output Rectifier Diode

The output rectifier diode supplies the current to the inductor when the high-side switch is off. A schottky diode is recommended to reduce losses due to the diode forward voltage and recovery times.

Loop Compensation

The system stability is controlled through the COMP pin. COMP is the output of the internal transconductance error amplifier. A series capacitor-resistor combination sets a pole-zero combination to control the feedback loop.

The DC loop gain is:

$$A_{VDC} = (V_{FB} / V_{OUT}) * A_{VEA} * G_{CS} * R_{LOAD}$$

Where:

V_{FB} is the feedback threshold voltage, 0.788V

V_{OUT} is the desired output regulation voltage

A_{VEA} is the transconductance error amplifier voltage gain, 400 V/V

G_{CS} is the current sense gain, (roughly the output current divided by the voltage at COMP), 5A/V

R_{LOAD} is the load resistance (V_{OUT} / I_{OUT} where I_{OUT} is the output load current)

The system has 2 poles. One is due to the compensation capacitor (C3), and the other is due to the output capacitor (C2). These are:

$$f_{P1} = G_{EA} / (2\pi * A_{VEA} * C3)$$

Where P1 is the first pole, and G_{EA} is the error amplifier transconductance (820 μ A/V).

and

$$f_{P2} = 1 / (2\pi * R_{LOAD} * C2)$$

The system has one zero of importance, due to the compensation capacitor (C3) and the compensation resistor (R1). The zero is:

$$f_{Z1} = 1 / (2\pi * R1 * C3)$$

If a large value capacitor (C2) with relatively high equivalent-series-resistance (ESR) is used, the zero due to the capacitance and ESR of the output capacitor can be compensated by a third pole set by R1 and C4. The pole is:

$$f_{P3} = 1 / (2\pi * R1 * C4)$$

The system crossover frequency (the frequency where the loop gain drops to 1, or 0dB) is important. A good rule of thumb is to set the crossover frequency to approximately 1/10 of the switching frequency. In this case, the switching frequency is 500KHz, therefore use a crossover frequency, f_C , of 50KHz. Lower crossover frequency results in slower loop response and poor load transient performance. Higher crossover frequency can result in loop instability.

Table 1. External components for typical designs

Vin(V)	Vout(V)	L1(uH)	C2(uF)	R2(K Ω)	R1(K Ω)	C3(nF)	C4(pF)
5	1.2	2.2	22*2	5.2	10	10	Open
5	1.8	3.3	22*2	12.8	10	10	Open
12	1.8	4.7	22*2	12.8	10	10	68
12	3.3	6.8	22*2	31.9	10	10	68
12	5	6.8	22*2	53.5	10	10	68
24	3.3	6.8	22*2	31.9	10	10	100
24	5	10	22*2	53.5	10	10	100

To simplify design efforts using the EUP3451, the typical designs for common applications are listed in Table 1.

Packaging Information

SOP-8

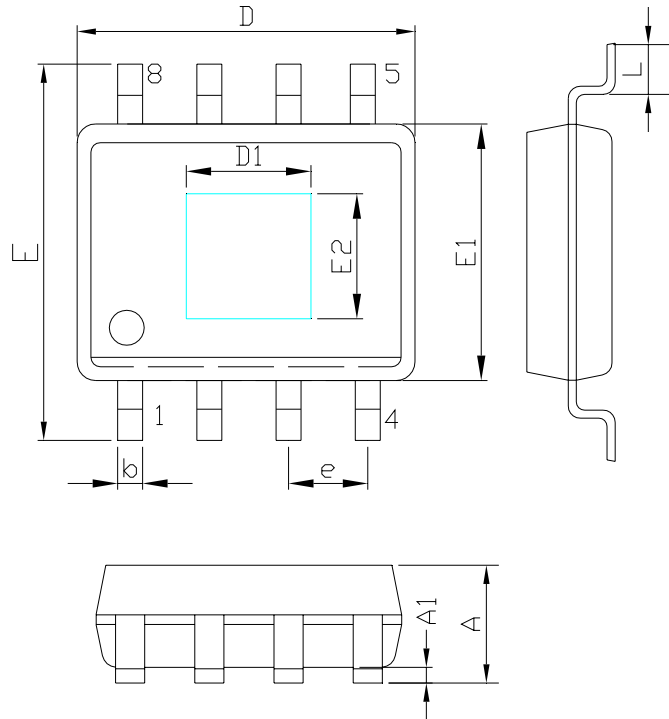

SYMBOLS	MILLIMETERS		INCHES	
	MIN.	MAX.	MIN.	MAX.
A	1.35	1.75	0.053	0.069
A1	0.10	0.25	0.004	0.010
D	4.90		0.193	
E1	3.90		0.153	
D1	2.00		0.081	
E2	2.00		0.081	
E	5.80	6.20	0.228	0.244
L	0.40	1.27	0.016	0.050
b	0.31	0.51	0.012	0.020
e	1.27		0.050	