

## Triple, Low-Noise, High-PSRR, 150mA LDO Without Bypass Capacitor

### DESCRIPTION

The EUP7221 is a high accuracy, low noise, high PSRR, triple CMOS low-dropout voltage regulator. Performance features include low output noise, high ripple rejection ratio, low dropout and very fast turn-on times.

The EUP7221 is also fully compatible with low ESR ceramic capacitors, reducing cost and improving output stability. This high level of output stability is maintained even during frequent load fluctuations, due to the excellent transient response performance and high PSRR achieved across a broad range of frequencies.

The EN function allows the output of channel2/1 regulator to be turned off, resulting in greatly reduced power consumption. The EUP7221 is available in SOT23-6 package.

### FEATURES

- Up to 150mA Output Current (Each LDO)
- $30\mu\text{V}_{\text{RMS}}$  Low Noise Output
- 60dB PSRR at 1KHz without Bypass Capacitor
- Low 70uA Ground Current Triple-LDO
- 190mV Dropout at 150mA
- One Shutdown pin Control Channel 2/1 Output Channel 1 starts after Channel 2 reaches 90% of Final Voltage
- Current Limiting and Thermal Protection
- Short Circuit Protection
- Available in SOT23-6 Package
- RoHS Compliant and 100% Lead(Pb)-Free Halogen-Free

### APPLICATIONS

- Cellular Phones
- Camera, Video Recorders
- PDAs and GPS
- Hand-held Equipment

### Typical Application Circuit

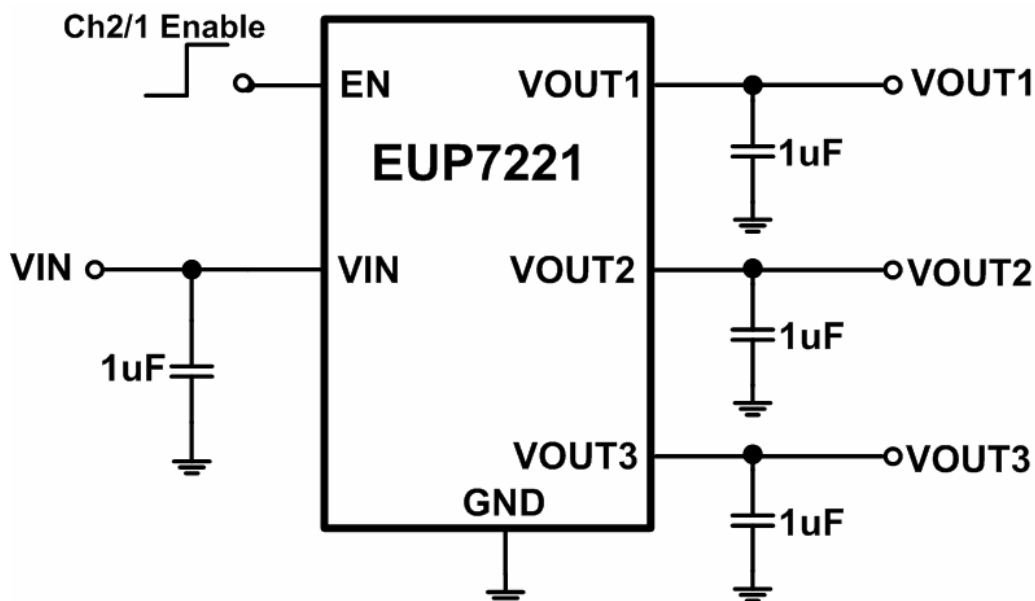

Figure1.

**Pin Configurations**

Package Type	Pin Configurations
SOT23-6	

**Pin Description**

PIN	SOT23-6	DESCRIPTION
VOUT3	1	Channel 3 Output Voltage
VIN	2	Supply Input. Bypass VIN to GND with a 1 $\mu$ F or greater capacitor.
EN	3	VOUT Enable control Pin. Only to shutdown VOUT1 and VOUT2. Active High Input. Do not leave floating.
VOUT1	4	Channel 1 Output Voltage
GND	5	Ground
VOUT2	6	Channel 2 Output Voltage

Ordering Information

Order Number	Package Type	Marking	Operating Temperature Range
EUP7221-1.8/2.8/3.3VIR1	SOT23-6	XXXXX AX3I	-40 °C to +85°C

EUP7221

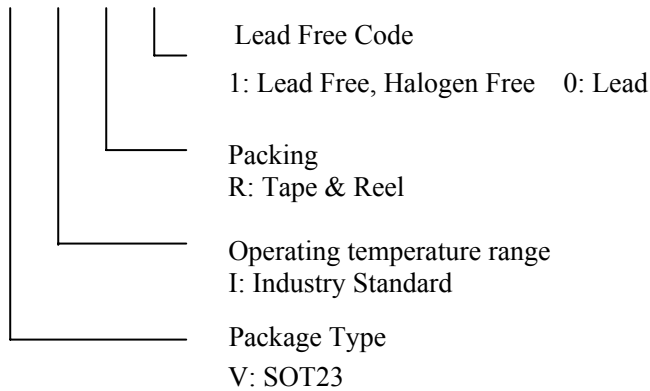

Block Diagram

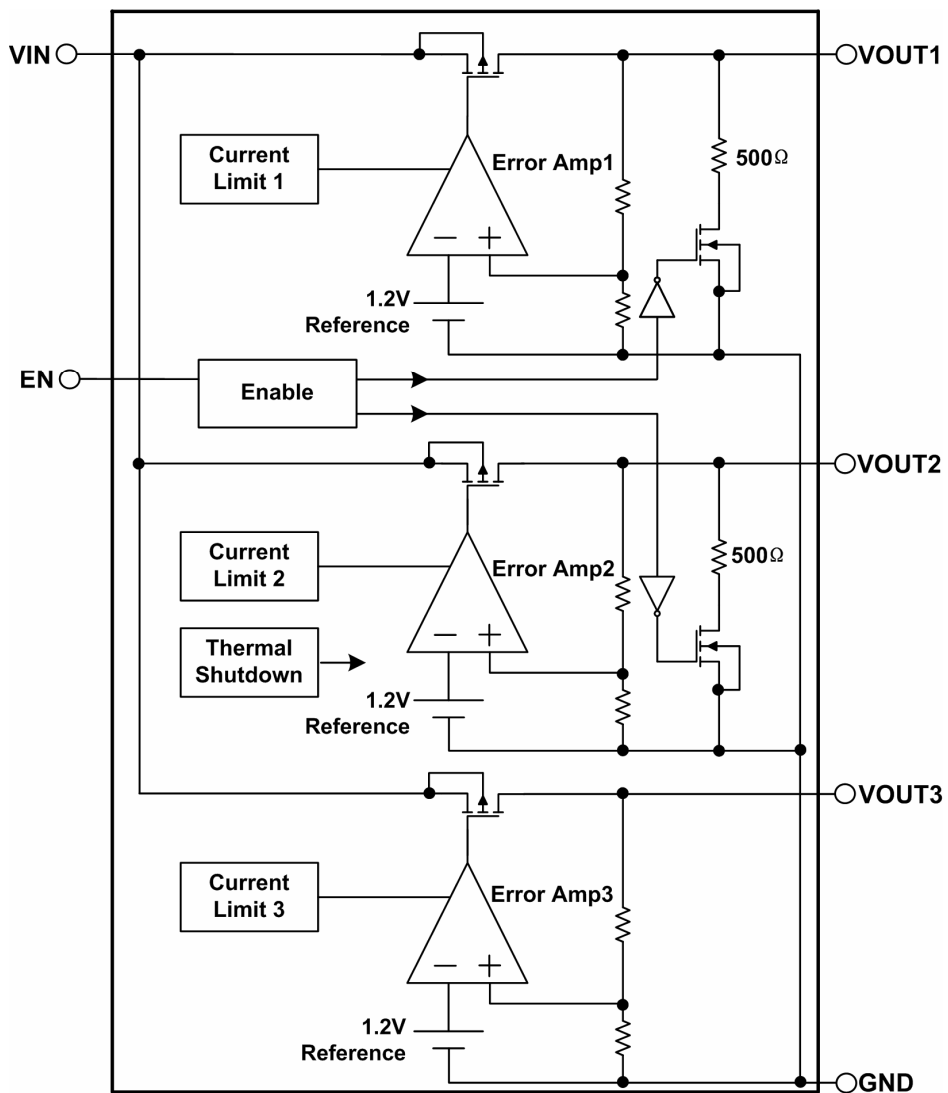

Figure2. Block Diagram

**Absolute Maximum Ratings (1)**

- Supply Input Voltage----- 6V
- Power Dissipation, PD @  $T_A=25^{\circ}\text{C}$  SOT23-6 ----- 0.488W
- Package Thermal Resistance SOT23-6, $\theta_{JA}$  -----  $205^{\circ}\text{C}/\text{W}$
- Lead Temperature (Soldering, 10 sec) -----  $260^{\circ}\text{C}$
- Storage Temperature Range-----  $-65^{\circ}\text{C}$  to  $+150^{\circ}\text{C}$
- ESD Rating Human Body Model ----- 2kV

**Recommended Operating Conditions (2)**

- Supply Input Voltage ----- 2.5 to 5.5V
- Enable Input Voltage ----- 0V to 5.5V
- Junction Temperature Range-----  $-40^{\circ}\text{C}$  to  $125^{\circ}\text{C}$

Note(1): Stress beyond those listed under “Absolute Maximum Ratings” may damage the device.

Note(2): The device is not guaranteed to function outside the recommended operating conditions.

**Electrical Characteristics**

$V_{IN}=4.3\text{V}$  whichever is greater,  $C_{IN}=C_{OUT}=1\mu\text{F}$ ,  $EN = V_{IN}$ ,  $T_A=25^{\circ}\text{C}$ . Unless otherwise noted.

Symbol	Parameter	Conditions	EUP7221			Unit
			Min.	Typ.	Max.	
	Input Voltage		2.5		5.5	V
$V_{OUT}$	Output Voltage	$I_{OUT}=1\text{mA}$ to $30\text{mA}$ , $T_A=25^{\circ}\text{C}$	-2		2	%
		$I_{OUT}=1\text{mA}$ to $30\text{mA}$ , $T_A=-40^{\circ}\text{C}$ ~ $85^{\circ}\text{C}$	-3		3	%
$I_{MAX}$	Maximum Output Current	Continuous, $T_A=-40^{\circ}\text{C}$ ~ $85^{\circ}\text{C}$	150	250		mA
$I_{LIM}$	Current Limit	$V_{OUT}=V_{OUT(nom)}\times 90\%$	160	300		mA
$I_G$	Quiescent Current	No Load (three channels)		70	100	$\mu\text{A}$
$V_{DROP}$	Dropout Voltage	$I_{OUT}=150\text{mA}$		190		mV
$\Delta V_{OUT}$	Load Regulation	$1\text{mA}<I_{OUT}<150\text{mA}$		15	30	mV
$\Delta V_{LINE}$	Line Regulation	$V_{IN}=V_{OUT}+0.5\text{V}$ to $5.5\text{V}$ $I_{OUT}=10\text{mA}$		0.02	0.15	%/V
$V_{IH}$	EN Input High Threshold	$V_{IN}=2.5\text{V}$ to $5.5\text{V}$ , $T_A=-40^{\circ}\text{C}$ ~ $85^{\circ}\text{C}$	1.5			V
$V_{IL}$	EN Input Low Threshold	$V_{IN}=2.5\text{V}$ to $5.5\text{V}$ , $T_A=-40^{\circ}\text{C}$ ~ $85^{\circ}\text{C}$			0.4	V
PSRR	Ripple Rejection Rate	$I_{OUT}=10\text{mA}$ , $f=1\text{kHz}$		60		dB
V(rms)	Output Noise Voltage (RMS)	$F=10\text{Hz}\sim 100\text{kHz}$ , $V_{OUT}=1.8\text{V}$ , No Load		30		$\mu\text{V}$
$T_{SD}$	Thermal Shutdown Temperature			165		$^{\circ}\text{C}$
$\Delta T_{SD}$	Thermal Shutdown Hysteresis			20		$^{\circ}\text{C}$

Typical Operating Characteristics

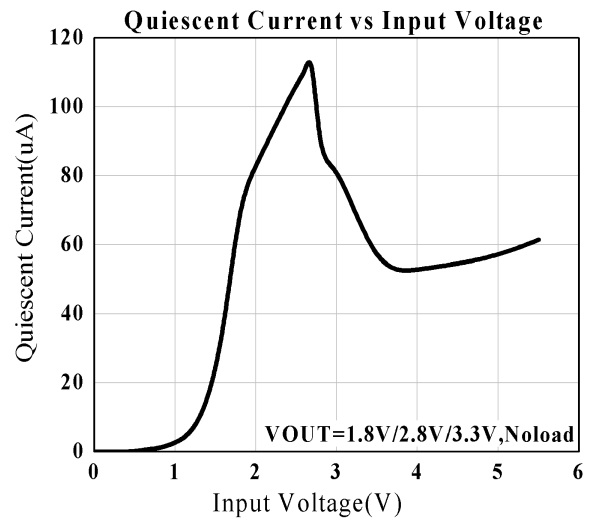
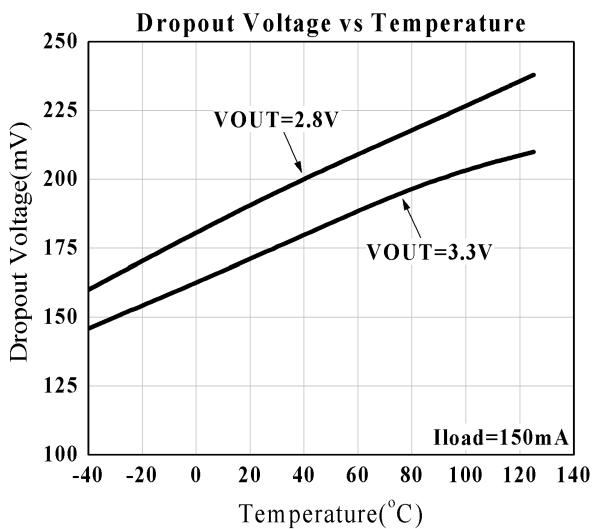
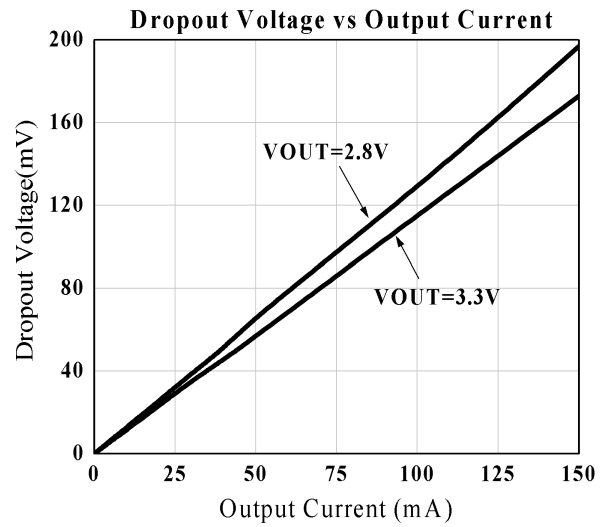
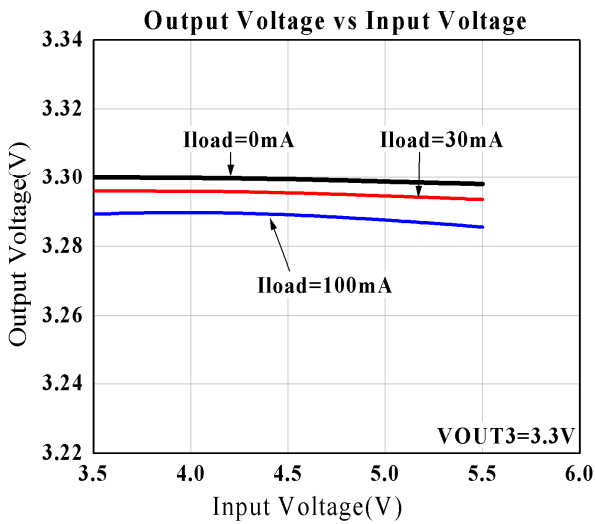
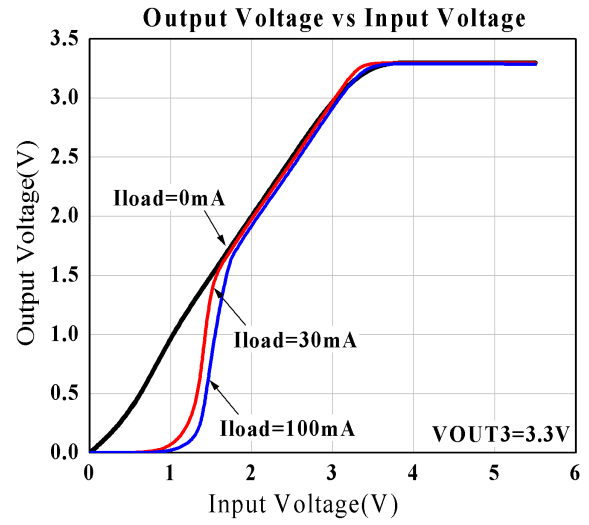
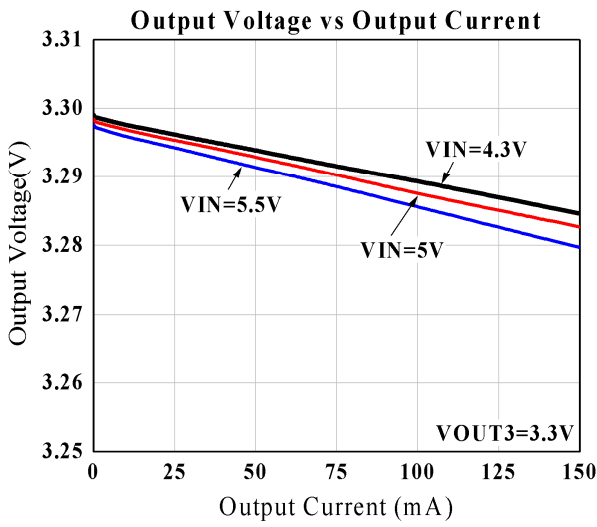

Typical Operating Characteristics (continued)

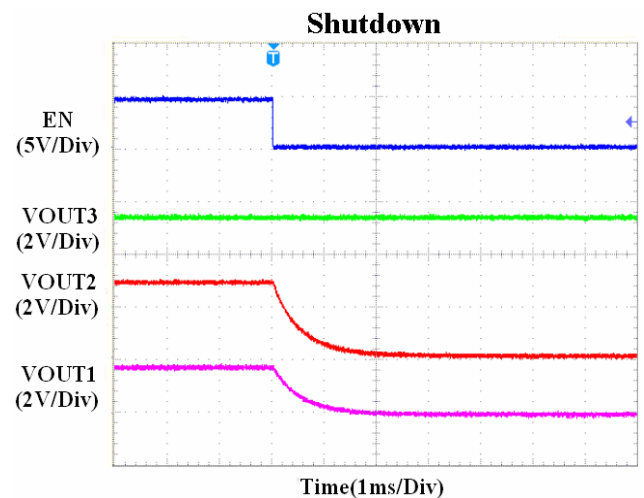
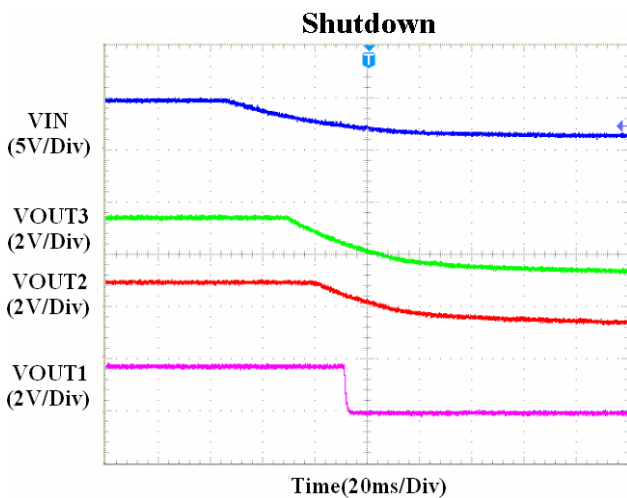
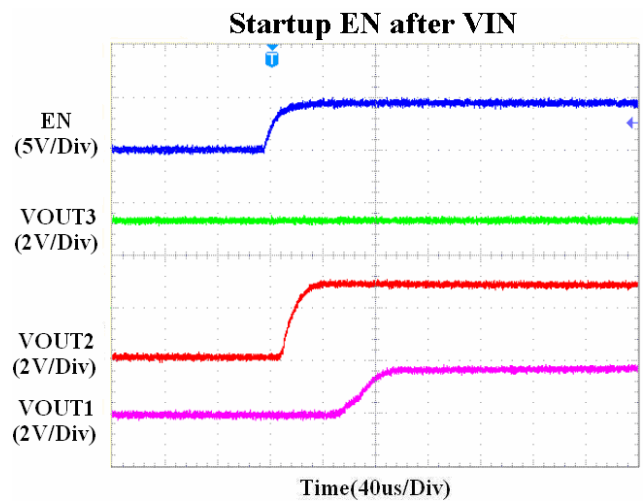
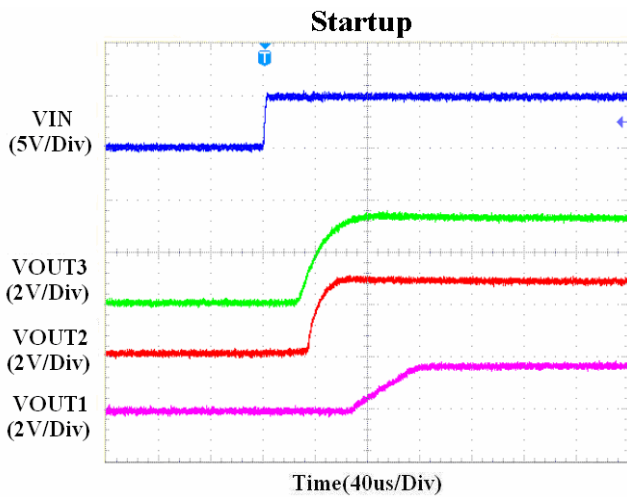
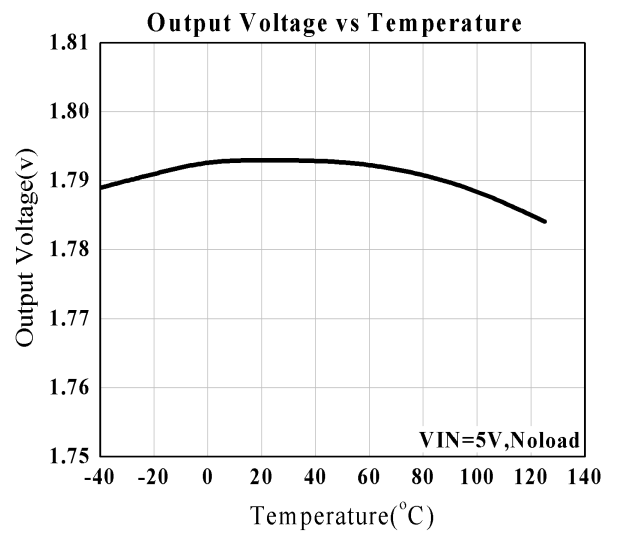
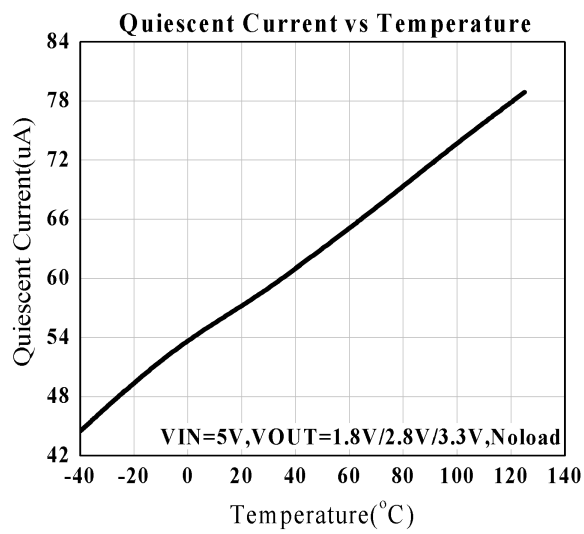

Typical Operating Characteristics (continued)

Load Transient Response

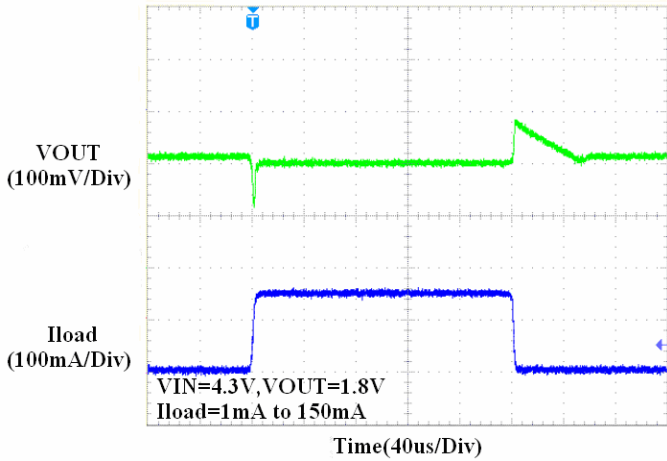

Load Transient Response

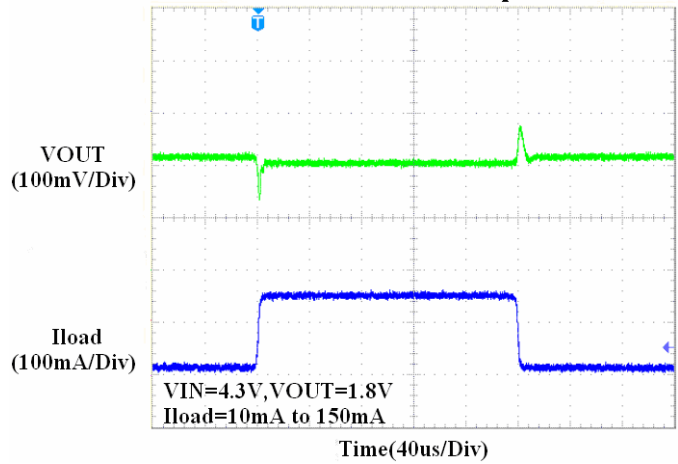

Load Transient Response

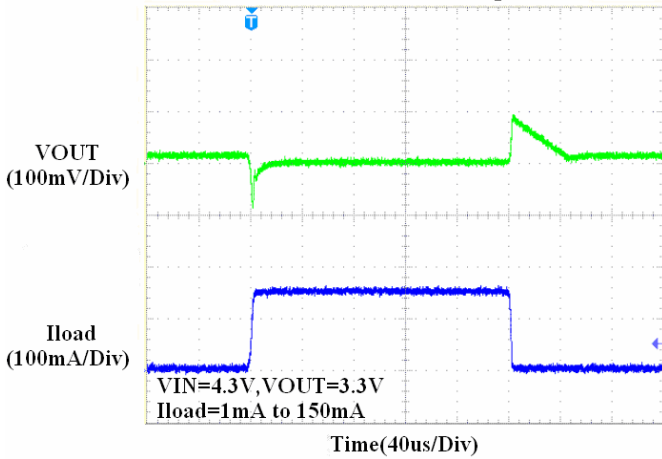

Load Transient Response

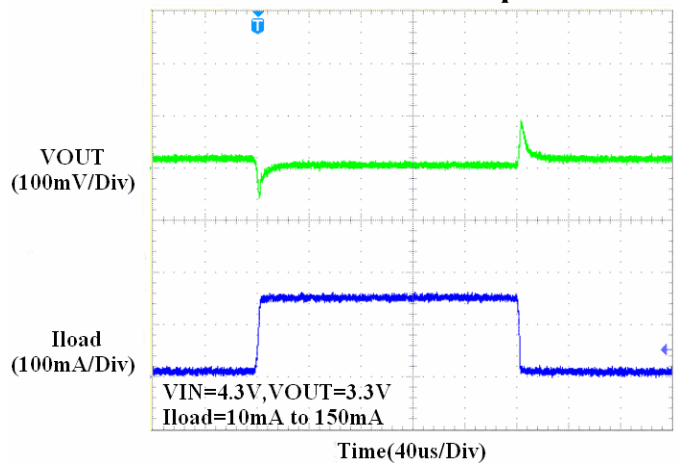

Line Transient Response

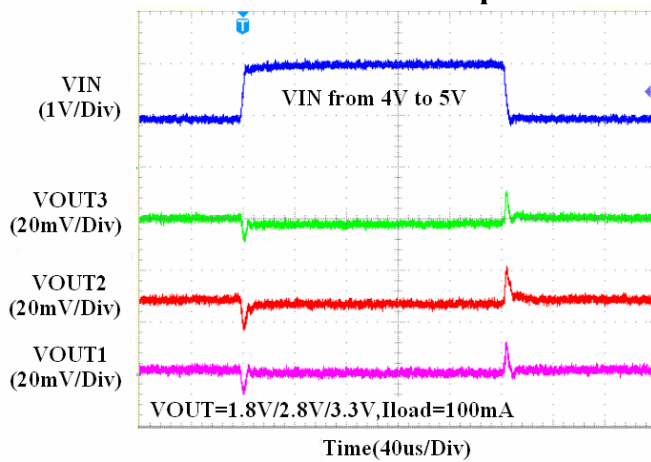

PSRR

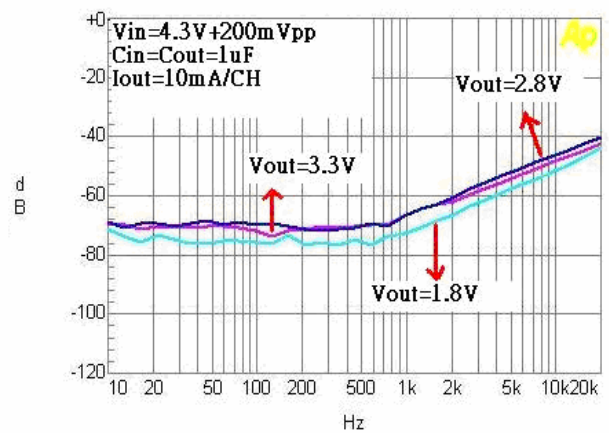

Typical Operating Characteristics (continued)

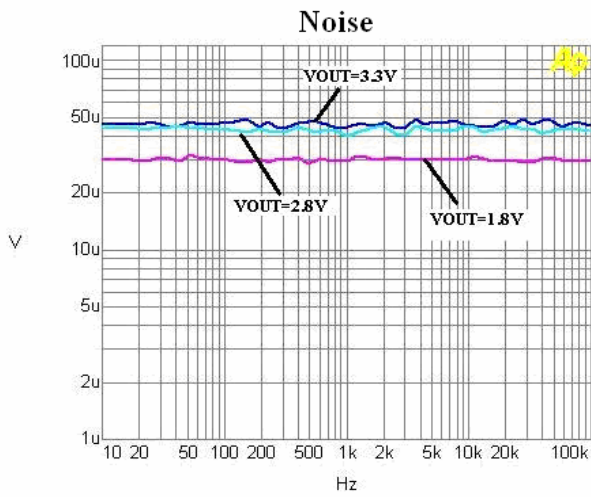



## Application Note

### External Capacitors

Like any low-dropout regulator, the EUP7221 requires external capacitors for regulator stability. The EUP7221 is specifically designed for portable applications requiring minimum board space and smallest components. These capacitors must be correctly selected for good performance.

### Input Capacitor

An input capacitance of  $1\mu\text{F}$  or higher is required between the EUP7221 input pin and ground (the amount of the capacitance may be increased without limit). This capacitor must be located a distance of not more than 1cm from the input pin and returned to a clean analog ground. Any good quality ceramic, tantalum, or film capacitor may be used at the input. If a tantalum capacitor is used at the input, it must be guaranteed by the manufacturer to have a surge current rating sufficient for the application.

There are no requirements for the ESR on the input capacitor, but tolerance and temperature coefficient must be considered when selecting the capacitor to ensure the capacitance will be  $1\mu\text{F}$  over the entire operating temperature range. If the PCB metal trace of VIN or GND to power is much longer, a larger input capacitor should be used for input filter.

### Output Capacitor

The EUP7221 is designed specifically to work with very small ceramic output capacitors. A ceramic capacitor (temperature characteristics X7R or X5R) in  $1\mu\text{F}$  to  $10\mu\text{F}$  range with  $5\text{m}\Omega$  to  $500\text{m}\Omega$  ESR range is suitable in the EUP7221 application circuit. The output capacitor must meet the requirement for minimum amount of capacitance to maintain good loop stability and phase margin.

### No-Load Stability

The EUP7221 is stable without any external load. This is especially important for CMOS RAM keep-alive applications.

### On/Off Input Operation

The channel2 and channel1 are turned off by pulling the EN pin low, and turned on by pulling it high. If this pin is floating, the channel2 and channel1 are uncertainty. To assure proper operation, the signal source used to drive the EN input must be able to swing above and below the specified turn-on/off voltage thresholds listed in the Electrical Characteristics. When EN is logic low, outputs of channel2 and channel1 are internally discharged to GND through a  $500\Omega$  resistor.

### Power On/Off Sequence

The channel3 is turned on when VIN is on. The channel2 is turned on by pulling the EN pin high. When channel2 is 90% of its normal value, the channel1 is turned on. If EN is low, the channel1 and the channel2 are all turned off.

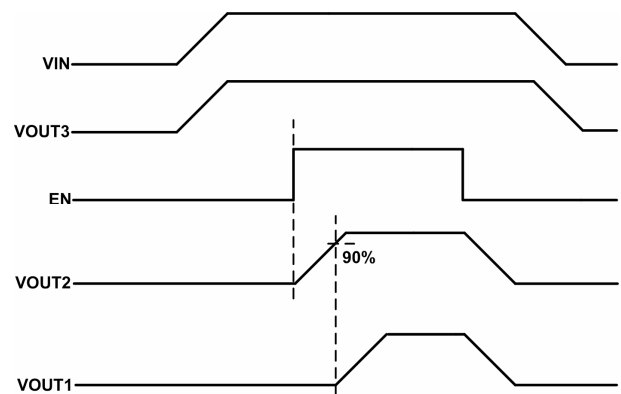

## Packaging Information

## SOT23-6

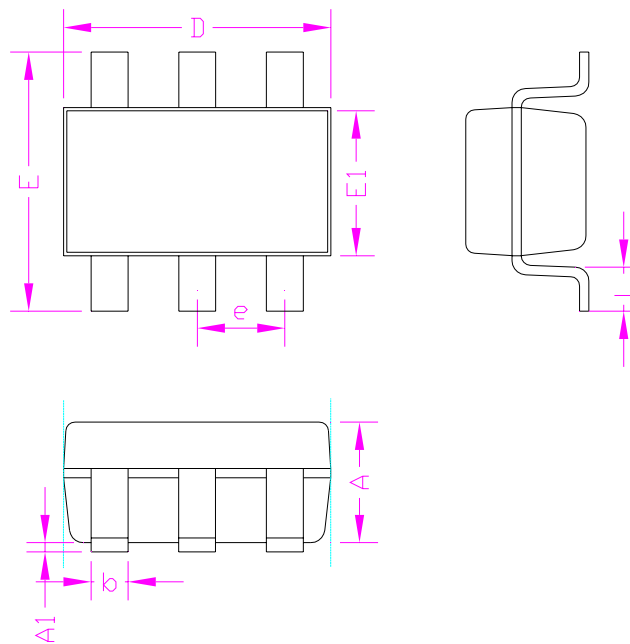

SYMBOLS	MILLIMETERS		INCHES	
	MIN.	MAX.	MIN.	MAX.
A	-	1.45	-	0.057
A1	0.00	0.15	0.000	0.006
b	0.30	0.50	0.012	0.020
D	2.90		0.114	
E1	1.60		0.063	
e	0.95		0.037	
E	2.60	3.00	0.102	0.118
L	0.3	0.60	0.012	0.024