

1A Ultra Low-Dropout Linear Regulator

DESCRIPTION

The EUP7961 is a 1A low-dropout linear regulator that provides a low voltage, high current output with minimum external components. The features include precision output voltage, ultra-low dropout voltage, and low ground current.

The EUP7961 operates from an input of 2.5V to 5.5V. This regulator uses a 1 μ F ceramic input capacitors and a 4.7 μ F ceramic output capacitor to deliver 1A output current. High bandwidth provides excellent transient response. It is designed to power digital circuits requiring low voltage with high currents (i.e., PLDs, DSPs, microcontrollers, etc.).

Other features include thermal and current limit protection, a logic-control shutdown mode and an error flag output that goes low when the output voltage drops 10% below the nominal value.

It is available in fixed output voltages of 1.2V, 1.5V, 1.8V, 2.5V, 3.3V or adjustable output voltage with a 0.8V feedback voltage. The adjustable output voltage can be set from 0.8V to 4.5V.

FEATURES

- 1A Guaranteed Output Current
- 300mV Dropout Voltage at 1A Output
- Stable with Ceramic Capacitors
- $\pm 1.8\%$ Output Voltage Accuracy
- 300 μ A Low-Ground Pin Current
- 0.1 μ A Quiescent Current in Shutdown Mode
- Excellent Line and Load Regulation
- Thermal Shutdown and Current Limit Protection
- Error Flag Indication
- Available in SOT223, SOP-8 and SOT-89 Packages
- RoHS Compliant and 100% Lead (Pb)-Free

APPLICATIONS

- Supply for Low-Voltage Digital IC
- PC Add-In Cards
- High Efficiency Linear Power Supplies
- Post Regulator

Typical Application Circuit

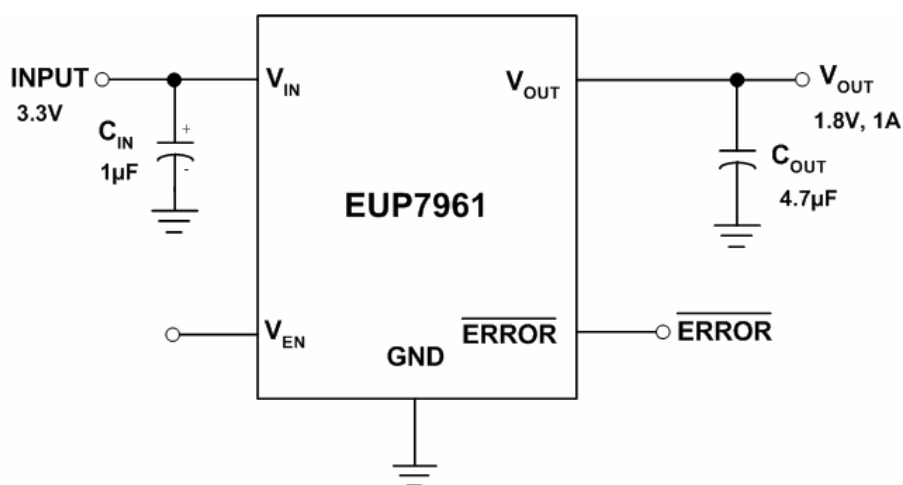

Figure1.

Block Diagram

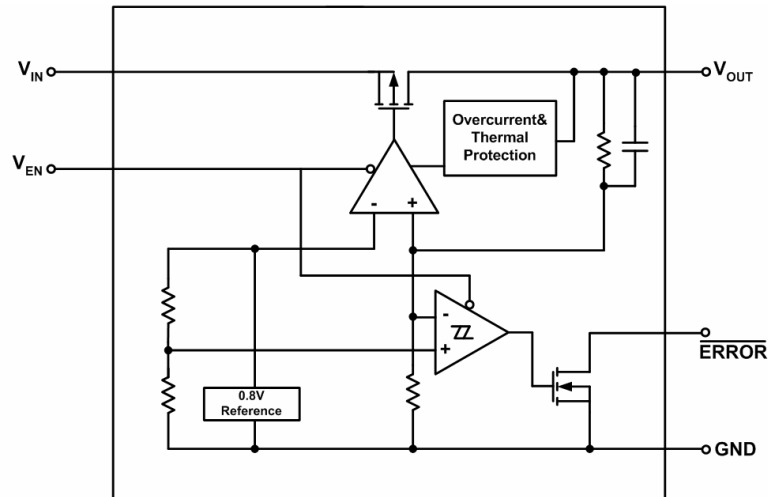

Figure2.

















Pin Configurations

Package Type	Pin Configurations	Package Type	Pin Configurations
SOT223-3		SOT223-3 (B)	
SOT223-3 (C)		SOT-89	
SOP-8			









Pin Description

PIN	SOT-223	SOT-223 (B)	SOT-223 (C)	SOT-89	SOP-8	DESCRIPTION
V _{EN}	-	-	-	-	1	Enable Input. Logic high=enable, Logic low=shutdown
V _{IN}	1	3	2	3	2	Input Voltage of the LDO
GND	2	1	1	2	5,6,7,8	Ground: TAB is connected to ground
V _{OUT}	3	2	3	1	3	Output voltage of the LDO
ERROR	-	-	-	-	4	ERROR Flag Output. Active-low indicated an output fault condition
ADJ	-	-	-	-		Adjustable Regulator Feedback Input. Connect to resistor voltage divider

Ordering Information

Order Number	Package Type	Marking	Operating Temperature Range
EUP7961-12BIR1	SOT223	 xxxxx P7961T	-40 °C to +85°C
EUP7961-15BIR1	SOT223	 xxxxx P7961C	-40 °C to +85°C
EUP7961-18BIR1	SOT223	 xxxxx P7961D	-40 °C to +85°C
EUP7961-25BIR1	SOT223	 xxxxx P7961B	-40 °C to +85°C
EUP7961-33BIR1	SOT223	 xxxxx P7961H	-40 °C to +85°C
EUP7961B-12BIR1	SOT223	 xxxxx 7961TB	-40 °C to +85°C
EUP7961B-15BIR1	SOT223	 xxxxx 7961CB	-40 °C to +85°C
EUP7961B-18BIR1	SOT223	 xxxxx 7961DB	-40 °C to +85°C
EUP7961B-25BIR1	SOT223	 xxxxx 7961BB	-40 °C to +85°C
EUP7961B-33BIR1	SOT223	 xxxxx 7961HB	-40 °C to +85°C
EUP7961C-12BIR1	SOT223	 xxxxx 7961C 1T	-40 °C to +85°C
EUP7961C-15BIR1	SOT223	 xxxxx 7961C 1C	-40 °C to +85°C
EUP7961C-18BIR1	SOT223	 xxxxx 7961C 1D	-40 °C to +85°C
EUP7961C-25BIR1	SOT223	 xxxxx 7961C 1B	-40 °C to +85°C
EUP7961C-33BIR1	SOT223	 xxxxx 7961C 1H	-40 °C to +85°C
EUP7961-12CIR1	SOT-89	 xxxxx P7961T	-40 °C to +85°C
EUP7961-15CIR1	SOT-89	 xxxxx P7961C	-40 °C to +85°C

Ordering Information (continued)

Order Number	Package Type	Marking	Operating Temperature Range
EUP7961-18CIR1	SOT-89	 xxxxx P7961D	-40 °C to +85°C
EUP7961-25CIR1	SOT-89	 xxxxx P7961B	-40 °C to +85°C
EUP7961-33CIR1	SOT-89	 xxxxx P7961H	-40 °C to +85°C
EUP7961-12DIR1	SOP-8	 xxxxx EUP7961 T	-40 °C to +85°C
EUP7961-15DIR1	SOP-8	 xxxxx EUP7961 C	-40 °C to +85°C
EUP7961-18DIR1	SOP-8	 xxxxx EUP7961 D	-40 °C to +85°C
EUP7961-25DIR1	SOP-8	 xxxxx EUP7961 B	-40 °C to +85°C
EUP7961-33DIR1	SOP-8	 xxxxx EUP7961 H	-40 °C to +85°C
EUP7961DIR1	SOP-8	 xxxxx EUP7961 A	-40 °C to +85°C

EUP7961- □ □ □ □ □ □

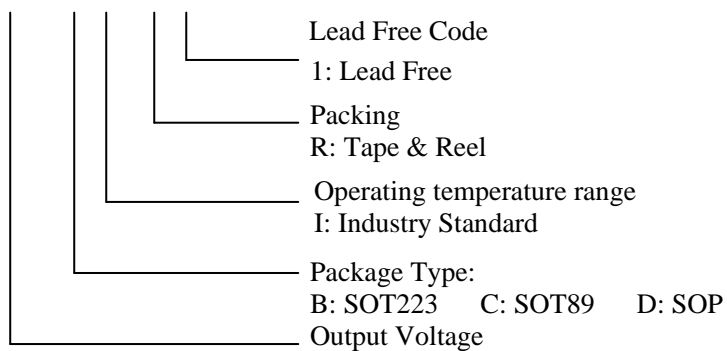

Absolute Maximum Ratings (1)

■	V_{IN}, V_{OUT} to GND	-----	-0.3V to 6V
■	Other Pins to GND	-----	-0.3V to 6V
■	Package Thermal Resistance		
	SOT-223, θ_{JA}	-----	100°C/W
	SOT-89, θ_{JA}	-----	100°C/W
	SOP-8, θ_{JA}	-----	125°C/W
■	Power Dissipation, PD@ $T_A = +25^\circ\text{C}$		
	SOT-223	-----	1.25W
	SOT-89	-----	1.25W
	SOP-8	-----	1W
■	Maximum Junction Temperature	-----	+150°C
■	Storage Temperature	-----	-65°C to +150°C
■	Lead Temp (Soldering 10sec.)	-----	+300°C
■	ESD Rating		
	Human Body Model	-----	2kV

Recommended Operating Conditions (2)

■	Supply Voltage V_{IN}	-----	2.5V to 5.5V
■	Enable Input Voltage	-----	0V to 5.5V
■	Operating Temperature Range	-----	-40°C to +85°C

Note (1): Stress beyond those listed under “Absolute Maximum Ratings” may damage the device.

Note (2): The device is not guaranteed to function outside the recommended operating conditions.

Electrical Characteristics

Specifications in standard type face are for $T_A = +25^\circ\text{C}$, and those with **boldface type** apply over the full operating temperature range $T_A = -40^\circ\text{C}$ to $+85^\circ\text{C}$. $V_{IN} = V_{OUT(NOM)} + 1\text{V}$, $V_{EN} = 5\text{V}$, $I_L = 10\text{mA}$, $C_{IN} = C_{OUT} = 4.7\mu\text{F}$ unless otherwise specified.

Symbol	Parameter	Conditions	EUP7961			Unit
			Min.	Typ.	Max.	
ΔV_{OUT}	Output Voltage Tolerance	$V_{OUT} + 1\text{V} \leq V_{IN} \leq 5.5\text{V}$ $10\text{mA} \leq I_L \leq 1\text{A}$ $T_A = +25^\circ\text{C}$	-1.8		1.8	%
		$V_{OUT} + 1\text{V} \leq V_{IN} \leq 5.5\text{V}$ $10\text{mA} \leq I_L \leq 1\text{A}$ $T_A = -40^\circ\text{C} \sim +85^\circ\text{C}$	-3		3	
	Line Regulation	$V_{OUT} + 1\text{V} \leq V_{IN} \leq 5.5\text{V}$		0.1	0.24	%
	Load Regulation	$10\text{mA} \leq I_L \leq 1\text{A}$		0.08	0.32	%
$V_{IN} - V_{OUT}$	Dropout Voltage	$I_L = 100\text{mA}$		35	50	mV
		$I_L = 1\text{A}$		300	500	
I_{GND}	Ground Pin Current in Normal Operation Mode	$I_L = 10\text{mA}$		300	360	μA
		$I_L = 1\text{A}$		500	600	
	Ground Pin Current in Shutdown Mode	$V_{EN} \leq 0.3\text{V}$		0.01	10	μA
$I_{O(PK)}$	Peak Output Current	$V_O \geq V_{O(NOM)} - 4\%$	1.1	1.5		A
Short Circuit Protection						
I_{SC}	Short Circuit Current		1.2	1.7		A

Electrical Characteristics (continued)

Specifications in standard type face are for $T_A = +25^{\circ}\text{C}$, and those with **boldface type** apply over the full operating temperature range $T_A = -40^{\circ}\text{C}$ to $+85^{\circ}\text{C}$. $V_{IN} = V_{OUT(NOM)} + 1\text{V}$, $V_{EN} = 5\text{V}$, $I_L = 10\text{mA}$, $C_{IN} = C_{OUT} = 4.7\mu\text{F}$ unless otherwise specified.

Symbol	Parameter	Conditions	EUP7961			Unit
			Min.	Typ.	Max.	
V_{IH}	Enable Threshold	Output = High	1.4	V_{IN}		V
V_{IL}		Output = Low		0	0.3	
T_{dOFF}	Turn-off delay	$I_L = 1\text{A}$		20	50	μs
T_{dON}	Turn-on delay	$I_L = 1\text{A}$		20	50	
I_{EN}	V_{EN} Pin Input Current	$V_{EN} = V_{IN}$	-1		1	μA
ERROR Flag						
V_T	Threshold		8	10	12	%
V_{TH}	Threshold Hysteresis			5		%
$V_{EF(Sat)}$	ERROR Flag Saturation	$I_{SINK} = 100\mu\text{A}$		0.02	0.1	V
T_d	Flag Reset Delay			1		μs
I_{IK}	ERROR Flag Pin Leakage Current			1		nA
I_{max}	ERROR Flag Pin Sink Current	$V_{Error} = 0.5\text{V}$		3.8		mA
AC Parameters						
PSRR	Ripple Rejection	$V_{IN} = V_{OUT} + 1\text{V}$ $C_{OUT} = 10\mu\text{F}$ $V_{OUT} = 3.3\text{V}$, $f = 120\text{Hz}$		60		dB
e_n	Output Noise Voltage	$BW = 10\text{Hz} - 100\text{kHz}$ $V_{OUT} = 2.5\text{V}$		150		$\mu\text{V(rms)}$
Over Temperature Protection						
$TSH(t)$	Shutdown Threshold			150		$^{\circ}\text{C}$
$TSH(h)$	Thermal Shutdown Hysteresis			10		$^{\circ}\text{C}$

Typical Operating Characteristics

Drop-Out Voltage Vs Temperature for Different Load Current

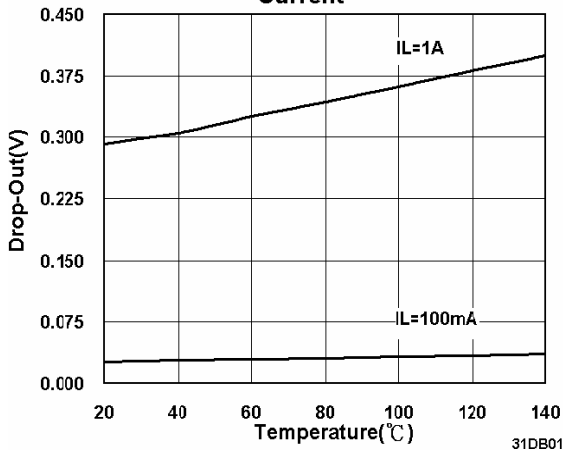

Load Transient Response

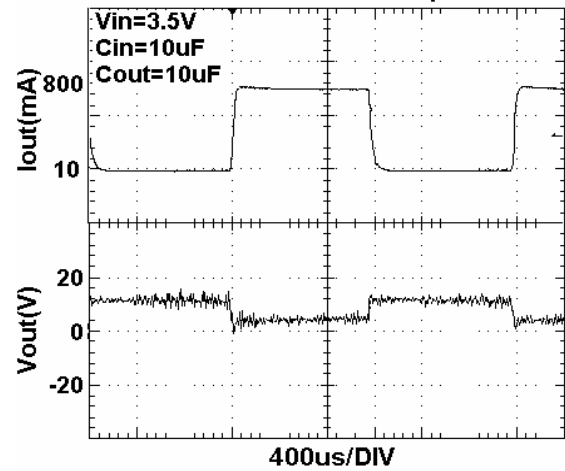

Ground Pin Current Vs Input Voltage(VSD=VIN)

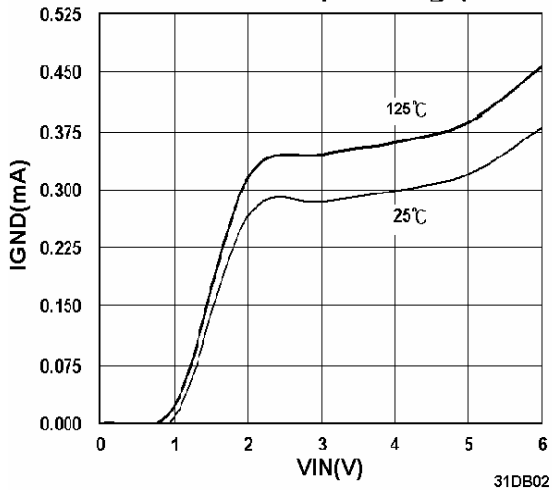

Input Voltage Vs Output Voltage

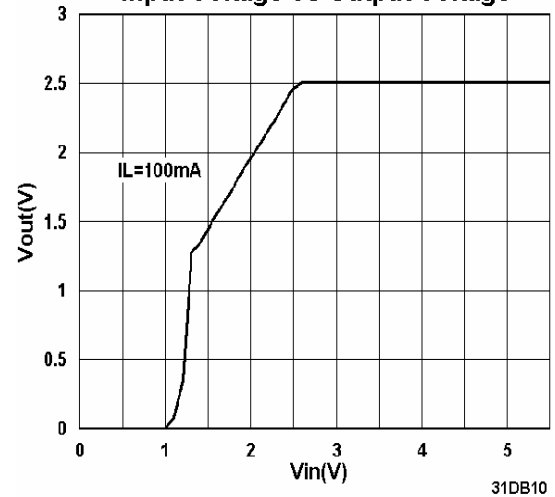

Ground Current Vs Temperature(VSD=VIN)

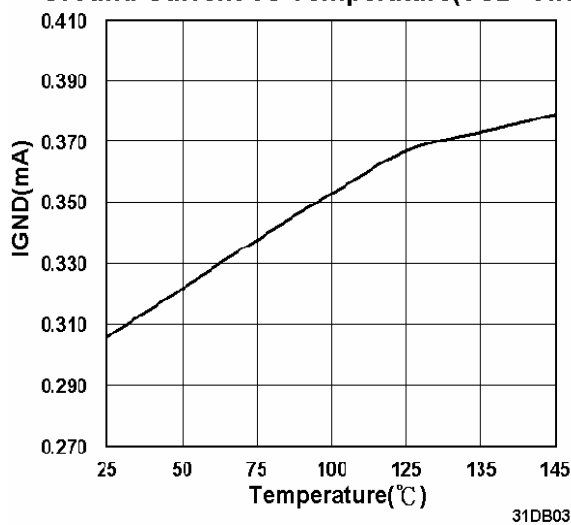

PSRR Output

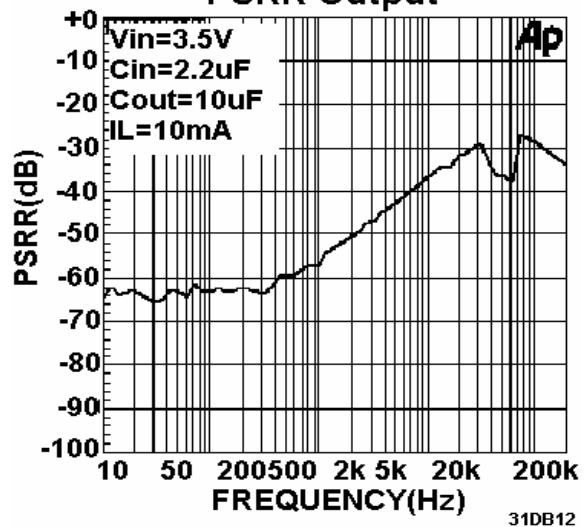

Typical Operating Characteristics (continued)

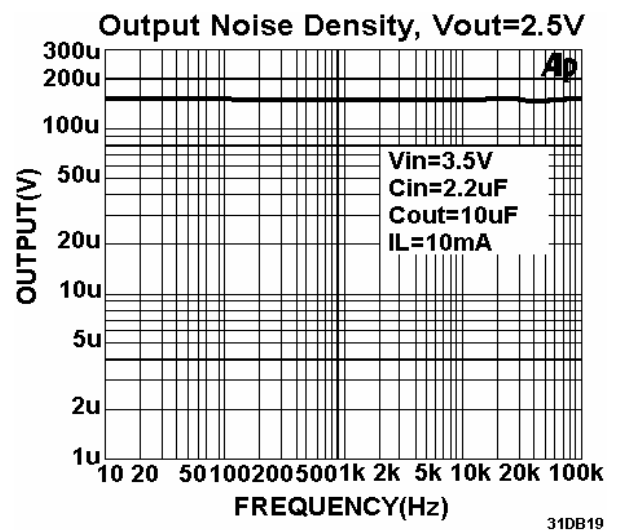
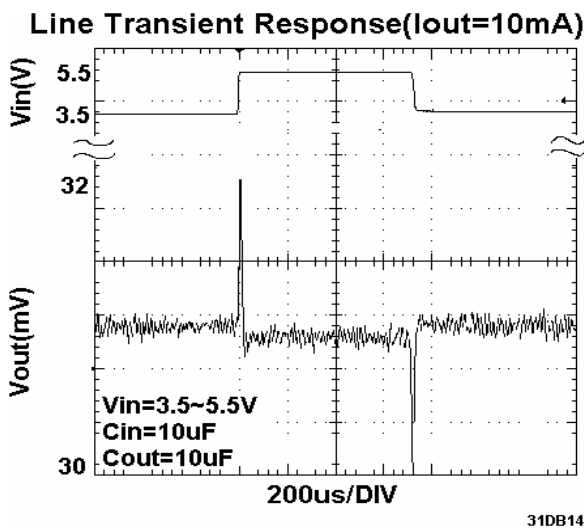
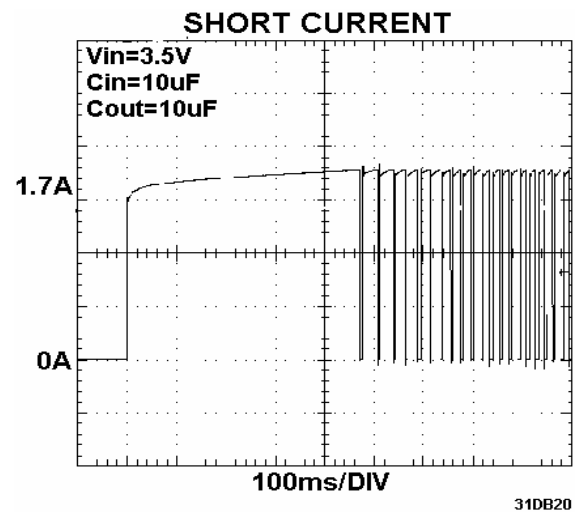
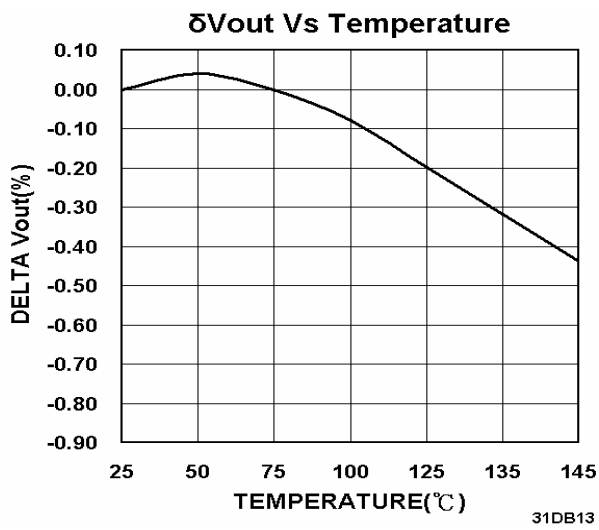

Application Note

Input Capacitor

An input capacitance of 1μF is required between the EUP7961 input pin and ground (the amount of the capacitance may be increased without limit). This capacitor must be located very close to the input pin and returned to a clean analog ground. Any good quality ceramic, tantalum, or film capacitor can be used at the input. If a tantalum capacitor is used at the input, it must be guaranteed by the manufacturer to have a surge current rating sufficient for the application. There are no requirements for the ESR on the input capacitor, but tolerance and temperature coefficient must be considered when selecting the capacitor to ensure the capacitance will be 1μF over the entire operating temperature range.

Output Capacitor

The EUP7961 is designed specifically to work with small ceramic output capacitors. A ceramic capacitor (temperature characteristics X7R, X5R, Z5U, or Y5V) in 4.7μF to 22μF range with 5mΩ to 200mΩ ESR range is suitable in the EUP7961 application circuit.

The output capacitor must meet the requirement for minimum 4.7μF over the entire operating range and also have an ESR (Equivalent Series Resistance) value which is within a stable range (5mΩ to 200mΩ)

No-Load Stability

The EUP7961 will remain stable and in regulation with no external load. This is specially important in CMOS RAM keep-alive applications.

On/Off Input Operation

The EUP7961 is turned off by pulling the V_{EN} pin low, and turned on by pulling it high. If this feature is not used, the V_{EN} pin should be tied to V_{IN} to keep the regulator output on at all time. To assure proper operation, the signal source used to drive the V_{EN} input must swing above and below the specified turn-on/off voltage thresholds listed in the Electrical Characteristics section under V_{IL} and V_{IH}.

ERROR Flag Operation

The EUP7961 produces a logic low signal at the ERROR Flag pin when the output drops out of regulation due to low input voltage, current limiting, or thermal limiting. This flag has a built in hysteresis.

The ERROR is an open drain output. Hence, the ERROR pin should be pulled high through a pull up resistor. The ERROR pin must be connected to ground if this function is not used. In shutdown, the ERROR pin is Hi-Z state to save input power.

Adjustable Operation

The adjustable version of the EUP7961 has an output voltage range of 0.8V to 4.5V. The output voltage of the EUP7961 adjustable regulator is programmed using an external resistor divider as shown in Figure3. The output

voltage is calculated using:

$$V_O = V_{ref} \times \left(1 + \frac{R_1}{R_2}\right)$$

Where:

V_{ref}= 0.8V typ. (the internal reference voltage)

Utilize the following equation for adjusting the output to a particular voltage:

$$P_I = R_2 \left[\frac{V_O}{0.8V} - 1 \right]$$

Choose R₂=50k to optimize accuracy, power supply rejection, noise and power consumption.

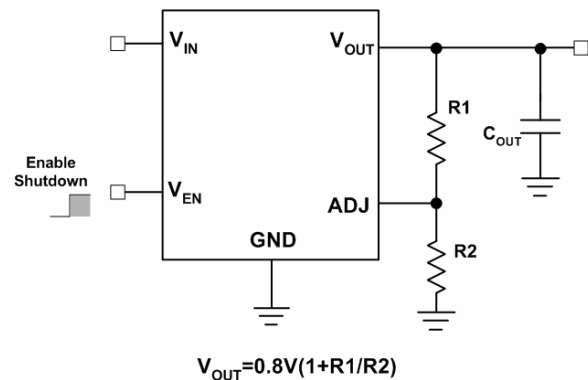

Figure3. Adjustable Regulator with Resistors

Power Dissipation

EUP7961 can deliver a continuous current of 2A over the full operating temperature range. A heatsink may be required depending on the maximum power dissipation and maximum ambient temperature of the application. Under all possible conditions, the junction temperature must be within the range specified under operating conditions. The total power dissipation of the device is given by:

$$P_D = (V_{IN} - V_{OUT})I_{OUT} + (V_{IN})I_{GND}$$

Where I_{GND} is the operating ground current of the device (specified under Electrical Characteristics).

The maximum allowable temperature rise (T_{Rmax}) depends on the maximum ambient temperature (T_{Amax}) of the application, and the maximum allowable junction temperature (T_{Jmax}):

$$T_{Rmax} = T_{Jmax} - T_{Amax}$$

The maximum allowable value for junction to ambient Thermal Resistance, θ_{JA}, can be calculated using the formula:

$$\theta_{JA} = T_{Rmax} / P_D$$

PCB Layout

Good PCB layout practices must be used, otherwise instability can be induced because of ground loops and voltages drops. The input and output capacitors must be directly connected to the input, output, and ground pins of the regulator using traces which do not have other currents flowing in them. The best way to do this is to lay out C_{IN} and C_{OUT} near the device with short traces to the V_{IN} , V_{OUT} , and ground pins. The regulator ground pin should be connected to the external circuit ground so that the regulator and its capacitors have a “single point ground”.

Packaging Information

SOT223-3

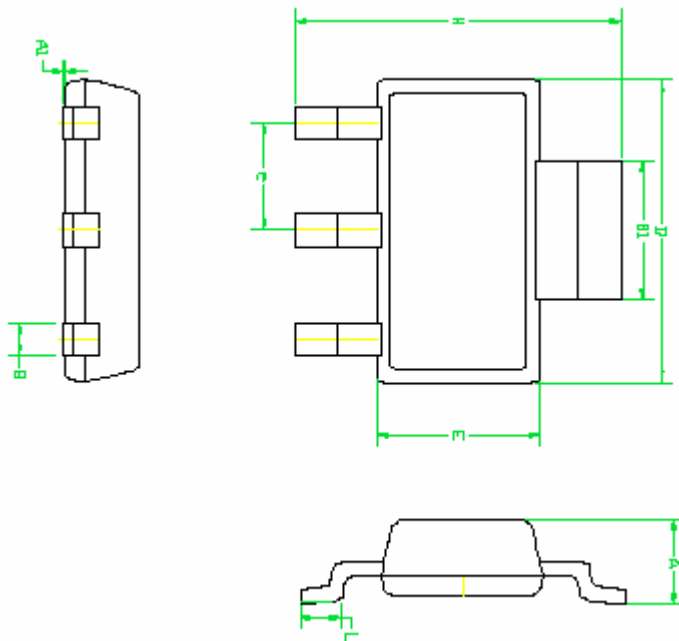

SYMBOLS	MILLIMETERS			INCHES		
	MIN.	NOM	MAX.	MIN.	NOM	MAX.
A	1.50	—	1.80	0.059	—	0.071
A1	0.00	—	0.10	0.000	—	0.004
B	0.60	0.70	0.84	0.024	0.028	0.033
B1	2.90	3.00	3.10	0.114	0.118	0.122
D	6.30	6.50	6.70	0.248	0.256	0.264
E	3.30	3.50	3.70	0.130	0.138	0.146
H	6.70	7.00	7.30	0.264	0.276	0.287
e	—	2.3	—	—	0.091	—
L	0.70	—	1.10	0.028	—	0.043

SOP-8

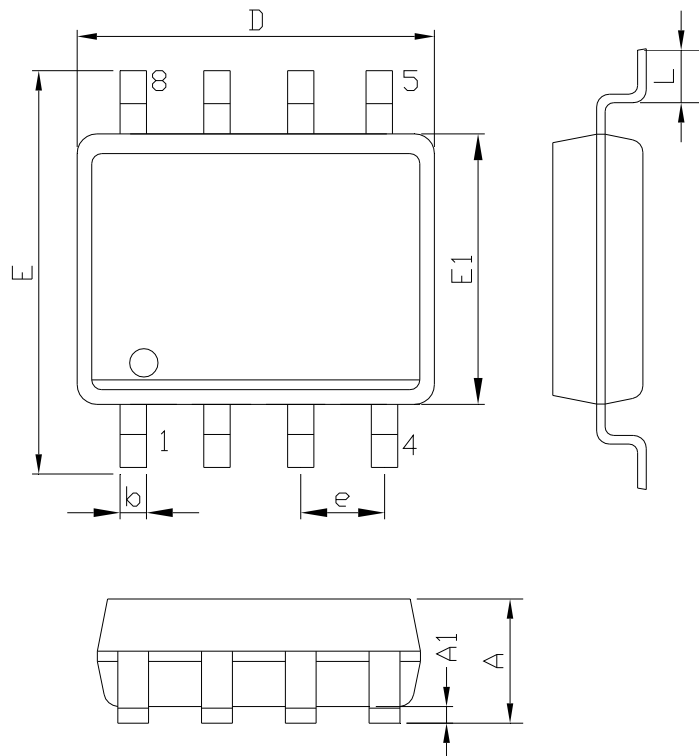

SYMBOLS	MILLIMETERS		INCHES	
	MIN.	MAX.	MIN.	MAX.
A	1.35	1.75	0.053	0.069
A1	0.10	0.25	0.004	0.010
D	4.90		0.193	
E	5.80	6.20	0.228	0.244
E1	3.90		0.153	
L	0.40	1.27	0.016	0.050
b	0.31	0.51	0.012	0.020
e	1.27		0.050	

SOT-89

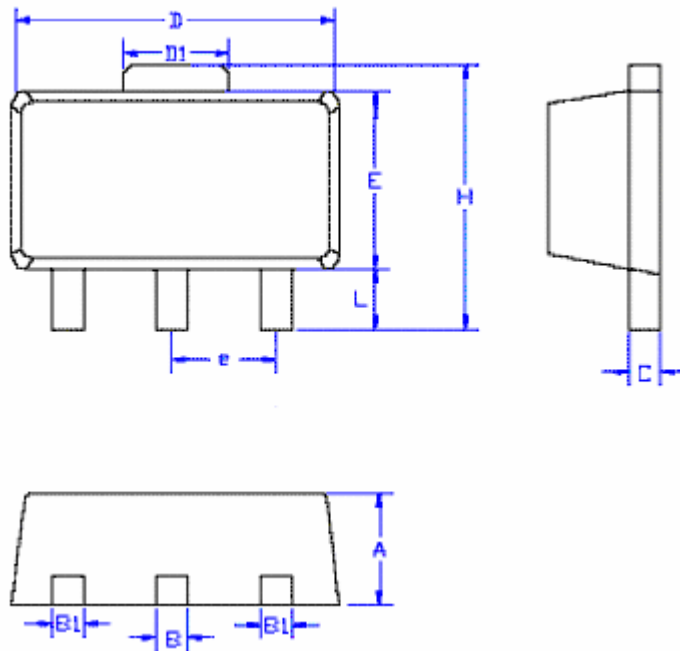

SYMBOLS	MILLIMETERS		INCHES	
	MIN.	MAX.	MIN.	MAX.
A	1.40	1.60	0.055	0.063
L	0.89	1.20	0.035	0.047
B1	0.36	0.48	0.014	0.019
B	0.44	0.56	0.017	0.022
C	0.35	0.44	0.014	0.017
D	4.40	4.60	0.173	0.181
D1	1.35	1.83	0.053	0.072
H	3.94	4.25	0.155	0.167
E	2.29	2.60	0.090	0.102
e	1.50		0.059	