



SP433

Constant Voltage and Constant Current Controller

DESCRIPTION

The SP433 is high-voltage four-terminal adjustable voltage references, with over current protection feature. The SP433 is a one chip solution to a 2.5V precision voltage reference and constant current output in the application of secondary feedback control of power supply, DC/DC converter, adaptor and charger. SP433 is idea for low cost switching power supply application.

APPLICATIONS

- Battery Charger
- Battery Power Equipment
- Linear Regulators
- Switch Power Supply
- Cellular Phone
- Digital Cameras
- Computer Disk Drivers
- Instrumentation

FEATURES

- Voltage Reference Accuracy of 0.5% & 1.0%
- Sink Current Capability from 1mA to 100mA
- Adjustable Output Voltage from VREF to 18V
- Low Output Noise
- Typical Output Dynamic Impedance Less Than 200mΩ
- Available in SOT-23-5L and TO-94 package
- Over Current Protection

PIN CONFIGURATION

TO-94

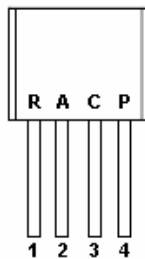

SOT-23-5L

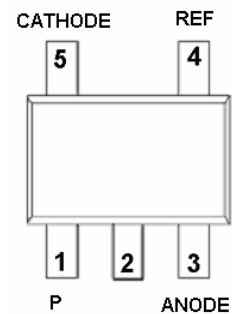

PART MARKING

TO-94

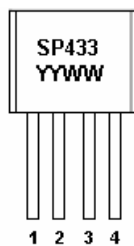

Y : Year Code
W : Weak Code

SOT-23-5L





SP433

Constant Voltage and Constant Current Controller

TYPICAL APPLICATION CIRCUIT

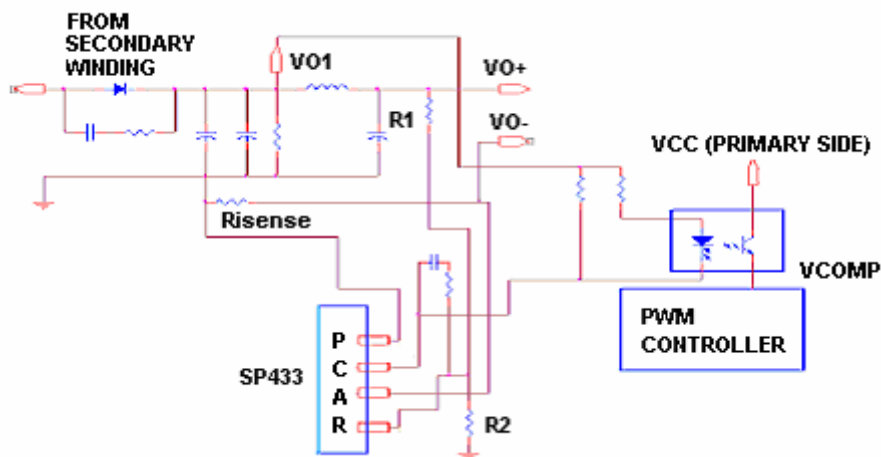

PIN DESCRIPTION (TO-94)

Pin	Symbol	Description
1	R	REF
2	A	ANODE
3	C	CATHODE
4	P	CURRENT ENABLE

PIN DESCRIPTION (SOT-23-5L)

Pin	Symbol	Description
1	P	CURRENT ENABLE
2	NC	NC
3	ANODE	ANODE
4	REF	REF
5	CATHODE	CATHODE

ORDERING INFORMATION

Part Number	Voltage Tolerance	Package	Part Marking
SP433AS25RGB	0.5%	SOT-23-5L	33AYW
SP433BS25RGB	1.0%	SOT-23-5L	33BYW
SP433AT94AGB	0.5%	TO-94	SP433
SP433BT94AGB	1.0%	TO-94	SP433

※ Week Code : A ~ Z (1 ~ 26) ; a ~ z (27 ~ 52)

※ SP433AS25RGB : Tape Reel ; Pb – Free ; Halogen -Free

※ SP433BS25RGB : Tape Reel ; Pb – Free ; Halogen -Free

※ SP433AT94AGB : Tape Ammo ; Pb-Free ; Halogen -Free

※ SP433BT94AGB : Tape Ammo ; Pb-Free ; Halogen -Free



SP433

Constant Voltage and Constant Current Controller

BLOCK DIAGRAM

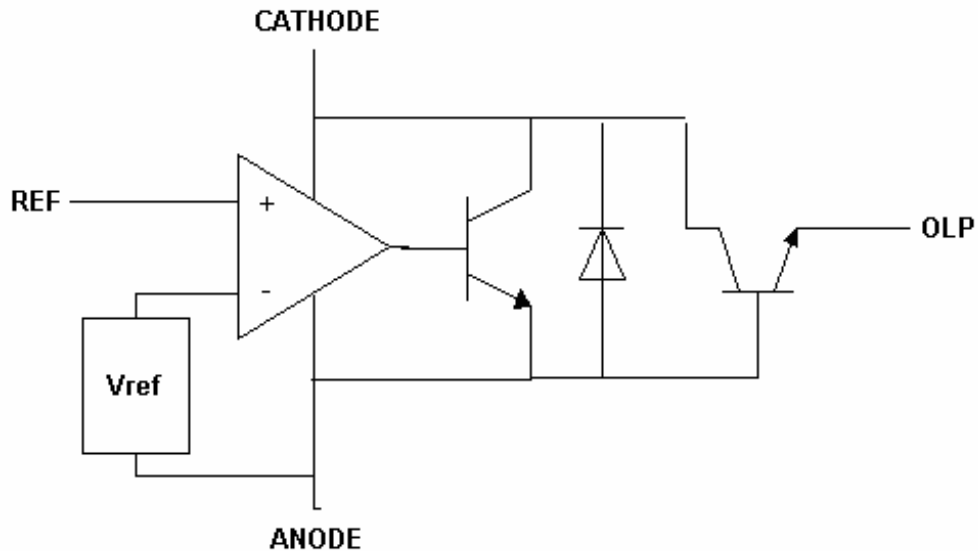

ABSOLUTE MAXIMUM RATINGS

($T_A=25^{\circ}\text{C}$ Unless otherwise specified)

Parameter	Symbol	Value	Unit
Cathode Voltage	V_Z	18	V
Continuous Cathode Current Range	I_Z	150	mA
Reference Current Range	I_{REF}	10	mA
Operating Junction Temperature Range	T_J	-40 ~ +150	$^{\circ}\text{C}$
Storage Temperature Range	T_{STG}	-65 ~ +150	$^{\circ}\text{C}$
Lead Temperature Range (Soldering 10Sec)	T_{SOL}	260	$^{\circ}\text{C}$
Thermal Resistance	Θ_{JA}	140	$^{\circ}\text{C}/\text{W}$

The IC has a protection circuit against static electricity. Do not apply high static electricity or high voltage that exceeds the performance of the protection circuit to the IC.



SP433

Constant Voltage and Constant Current Controller

ELECTRICAL CHARACTERISTICS

($T_A=25^{\circ}\text{C}$, Unless otherwise specified)

Parameter	Symbol	Conditions	Min	Typ	Max	Units
Reference Input Voltage ($I_K=10\text{mA}, V_Z=V_{REF}$)	V_{REF}	SP433A SP433B	2.487 2.475	2.5 2.5	2.513 2.525	V
V_{REF} Temp Deviation	V_{DEV}	$T_A=-40^{\circ}\text{C}\sim+80^{\circ}\text{C}$ $V_Z=V_{REF}$ $I_Z=10\text{mA}$		10	25	mV
Ratio Of Change In REF To Change In Cathode Voltage	$\frac{\Delta V_{REF}}{\Delta V_Z}$	$I_Z=10\text{mA},$ $\Delta V_Z = 18\text{V}\sim V_{REF}$		-1.4	-2.7	mV/V
Reference Input Current	I_{REF}	$I_Z=10\text{mA}$ $R_1=10\text{K}\Omega$ $R_2=\infty$			1	μA
I_{REF} Temp Deviation	$I_{REF(DEV)}$	$T_A=-40^{\circ}\text{C}\sim+80^{\circ}\text{C}$ $R_1=10\text{K}\Omega, R_2=\infty$ $I_Z=10\text{mA}$			2.5	μA
Off-State Cathode Current	$I_{Z(OFF)}$	$V_{REF}=0\text{V}, V_Z=18\text{V}$			0.1	μA
Dynamic Output Impedance	R_Z	$f<1\text{kHz}, V_Z=V_{REF}$ $I_Z=1\text{mA}\sim 100\text{mA}$		1.0	1.5	Ω
Minimum Operating Current	$I_{Z(MIN)}$	$V_Z=V_{REF}$			1.0	mA
Current Amplification	I_{amp}	$V_C=1\text{V}, I_A=50\mu\text{A}$	10			mA
Saturation Voltage	V_{sat}	$I_c=150\text{mA}, I_A=10\text{mA}$			0.8	V
Maximum Protection Current	I_P				100	mA



SP433

Constant Voltage and Constant Current Controller

APPLICATION NOTE

In the above application, SP433 is used to provide an accurate control of voltage and current. The voltage loop is controlled through an internal error amplifier, the resistor bridge R₁, R₂ and the photo-coupler. The relation between V_{out}, R₁, R₂ and V_{ref} is shown in:

$$V_{out} = V_{ref} \times (1 + R_1/R_2)$$

The current loop is controlled through an internal transistor, the sense resistor and the photo-coupler. The control equation is:

$$R_{isense} \times I_{limit} = 0.7V \text{ (typical)}$$

Where I_{limit} is the desired current limit. The selection of R_{isense} should consider the power loss through R_{isense}. It is calculated as:

$$P_{limit} = 0.7 \times I_{limit}$$

Whether AC input is at High Line or Low Line, SP433 can provide the same current protection. It has the fuse function at the output.



SP433

Constant Voltage and Constant Current Controller

PERFORMANCE CHARACTERISTICS

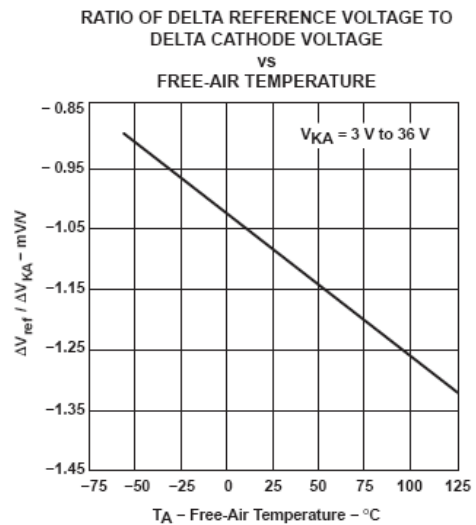
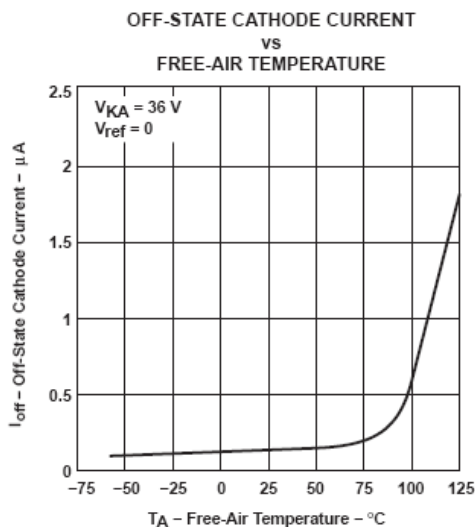
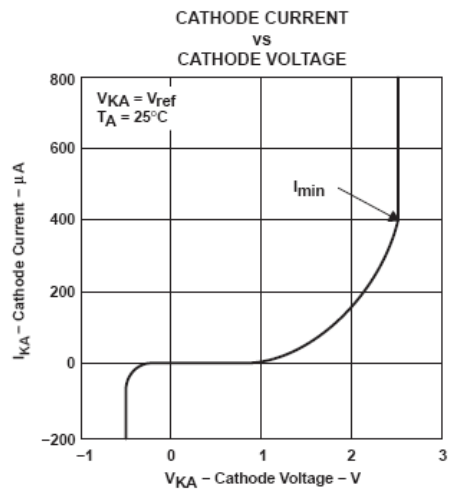
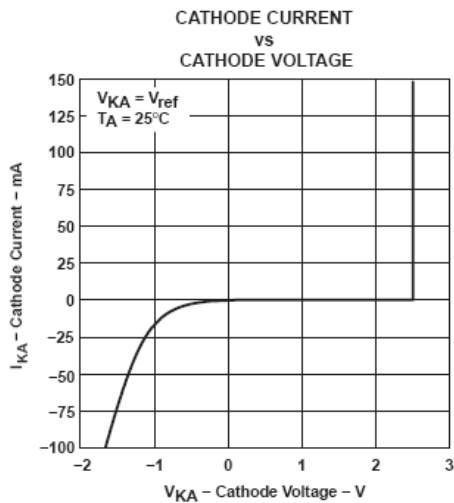
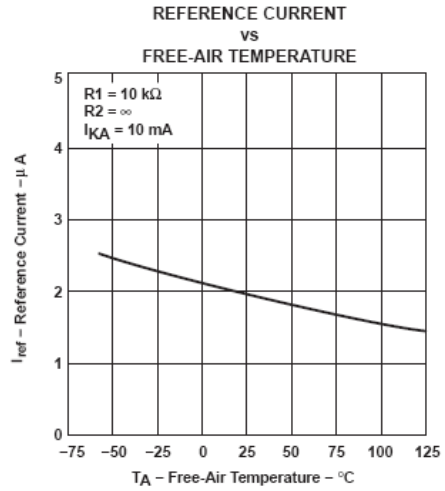
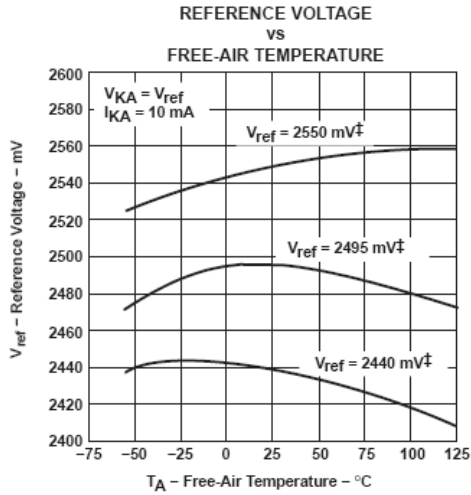



SP433

Constant Voltage and Constant Current Controller

PERFORMANCE CHARACTERISTICS

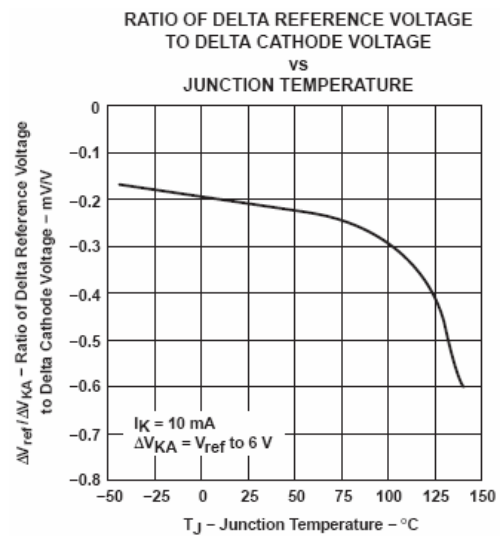
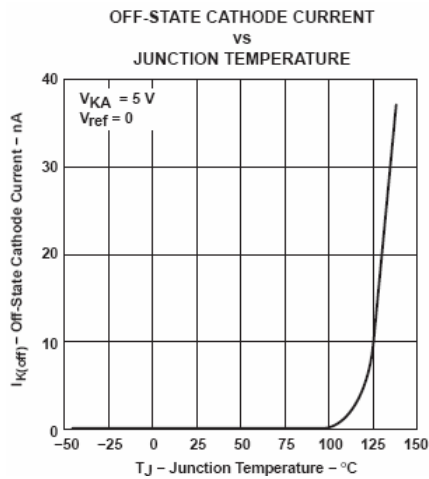
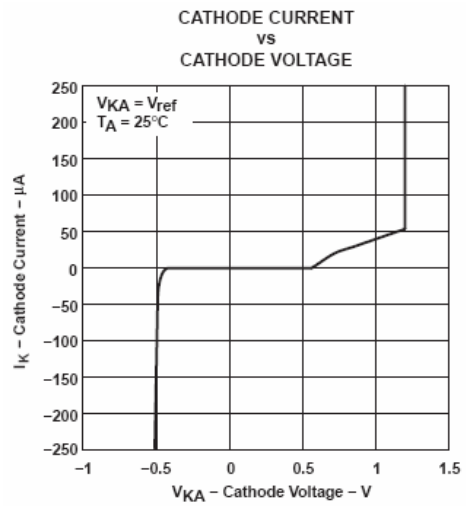
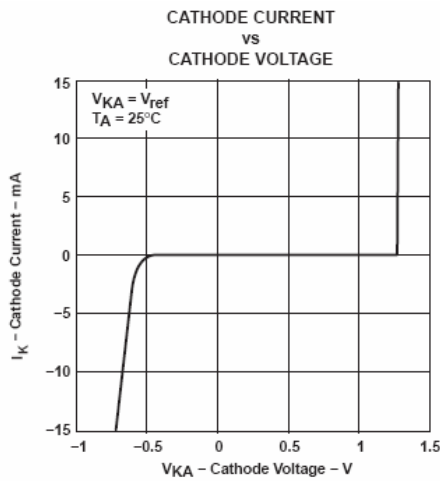
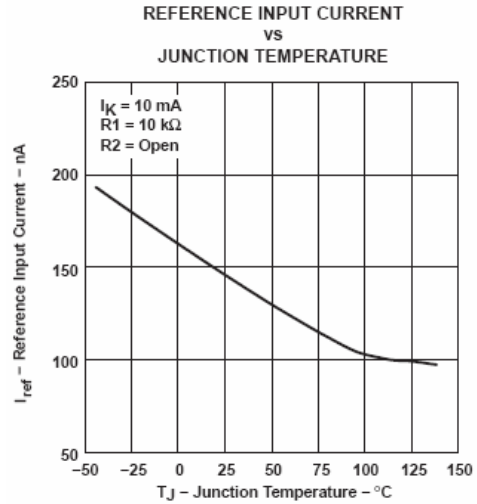
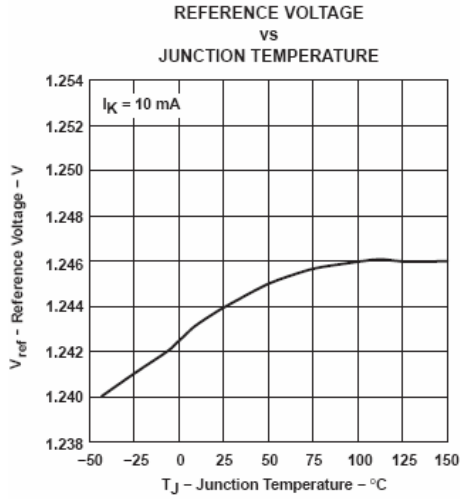



SP433

Constant Voltage and Constant Current Controller

SOT-23-5L PACKAGE OUTLINE

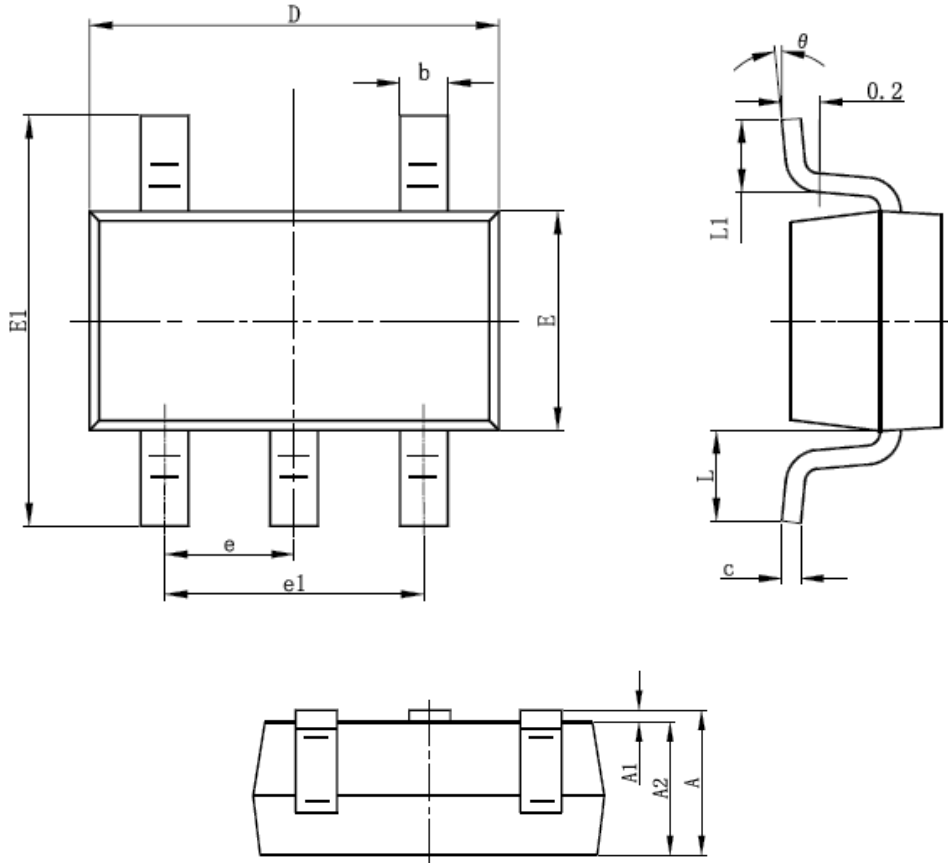

Symbol	Dimensions In Millimeters		Dimensions In Inches	
	Min	Max	Min	Max
A	1.050	1.250	0.041	0.049
A1	0.000	0.100	0.000	0.004
A2	1.050	1.150	0.041	0.045
b	0.300	0.400	0.012	0.016
c	0.100	0.200	0.004	0.008
D	2.820	3.020	0.111	0.119
E	1.500	1.700	0.059	0.067
E1	2.650	2.950	0.104	0.116
e	0.950TYP		0.037TYP	
e1	1.800	2.000	0.071	0.079
L	0.700REF		0.028REF	
L1	0.300	0.600	0.012	0.024
θ	0°	8°	0°	8°



SP433

Constant Voltage and Constant Current Controller

TO-94 PACKAGE OUTLINE

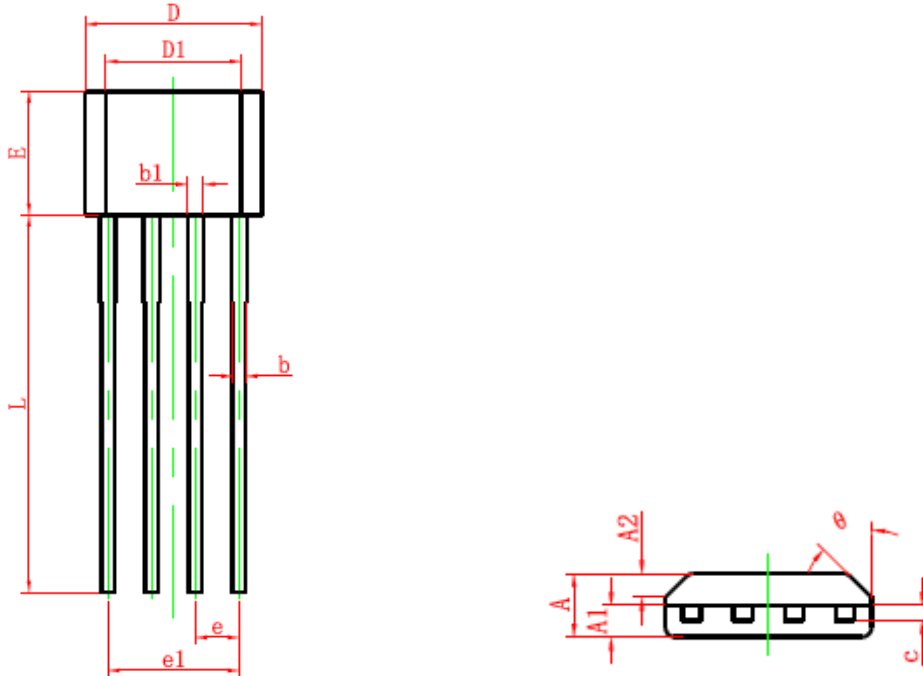

Symbol	Dimensions In Millimeters		Dimensions In Inches	
	Min	Max	Min	Max
A	1.400	1.800	0.055	0.071
A1	0.700	0.900	0.028	0.035
A2	0.500	0.700	0.020	0.028
b	0.360	0.500	0.014	0.020
b1	0.380	0.550	0.015	0.022
c	0.360	0.510	0.014	0.020
D	4.980	5.280	0.196	0.208
D1	3.780	4.080	0.149	0.161
E	3.450	3.750	0.136	0.148
e	1.270 TYP		0.050 TYP	
e1	3.710	3.910	0.146	0.154
L	14.900	15.300	0.587	0.602
θ	45° TYP		45° TYP	



SP433

Constant Voltage and Constant Current Controller

Information provided is alleged to be exact and consistent. SYNC Power Corporation presumes no responsibility for the penalties of use of such information or for any violation of patents or other rights of third parties which may result from its use. No license is granted by allegation or otherwise under any patent or patent rights of SYNC Power Corporation. Conditions mentioned in this publication are subject to change without notice. This publication surpasses and replaces all information previously supplied. SYNC Power Corporation products are not authorized for use as critical components in life support devices or systems without express written approval of SYNC Power Corporation.

©The SYNC Power logo is a registered trademark of SYNC Power Corporation

©2004 SYNC Power Corporation – Printed in Taiwan – All Rights Reserved

SYNC Power Corporation

7F-2, No.3-1, Park Street

NanKang District (NKSP), Taipei, Taiwan 115

Phone: 886-2-2655-8178

Fax: 886-2-2655-8468

©<http://www.syncpower.com>