



SPE1211

Single-Line ESD Protection Array

DESCRIPTION

The SPE1211 are designed by TVS device that is to protect sensitive electronics from damage or latch-up due to ESD. They are designed for use in applications where board space is at a premium. SPE1211 will protect single line, and may be used on line where the signal polarities swing above and below ground.

SPE1211 offer desirable characteristics for board level protection including fast response time, low operating and clamping voltage, and no device degradation.

SPE1211 may be used to meet the immunity requirements of IEC 61000-4-2, level 4. The small SOD-523 package makes them ideal for use in portable electronics such as cell phones, PDA's, notebook computers, and digital cameras.

APPLICATIONS

- ◆ Cellular Handsets and Accessories
- ◆ Cordless Phone
- ◆ PDA
- ◆ Notebooks and Handhelds
- ◆ Portable Instrumentation
- ◆ Digital Cameras
- ◆ MP3 Player

FEATURES

- ◆ Transient protection for data lines to IEC 61000-4-2 (ESD) $\pm 15\text{kV}$ (air), $\pm 8\text{kV}$ (contact)
IEC 61000-4-4 (EFT) 40A (5/50ns)
- ◆ Protects single I/O lines
- ◆ Working voltage: 12V
- ◆ Low leakage current
- ◆ Low operating and clamping voltages

PIN CONFIGURATION (SOD-523)



PART MARKING

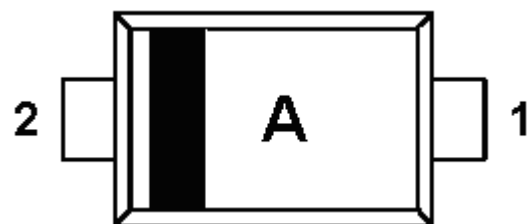



SPE1211

Single-Line ESD Protection Array

ORDERING INFORMATION

Part Number	Package	Part Marking
SPE1211D52RG	SOD-523	A
SPE1211D52RGB	SOD-523	A

- ※ SPE1211D52RG : Tape Reel ; Pb – Free
- ※ SPE1211D52RGB : Tape Reel ; Pb – Free ; Halogen – Free

ABSOLUTE MAXIMUM RATINGS

(TA=25°C Unless otherwise noted)

Parameter	Symbol	Typical	Unit
Peak Pulse Power (tp = 8/20 μs)	Ppk	300	W
Maximum Peak Pulse Current (tp = 8/20 μs)	Ipp	15	A
ESD per IEC 61000 – 4 – 2 (Air)	Vpp	±15	KV
ESD per IEC 61000 – 4 – 2 (Contact)	Vpp	±8	KV
Operating Junction Temperature	Tj	-55 ~ 125	°C
Storage Temperature Range	TSTG	-55 ~ 150	°C
Lead Soldering Temperature	TL	260 (10sec)	°C

ELECTRICAL CHARACTERISTICS

(TA=25°C Unless otherwise noted)

Parameter	Symbol	Conditions	Min.	Typ	Max.	Unit
Reverse Stand – Off Voltage	VRWM				12	V
Reverse Breakdown Voltage	VBR	It = 1mA	13.3			V
Reverse Leakage Current	IR	VRWM = 12V , T=25°C			1	μA
Clamping Voltage	Vc	Ipp = 5A , tp = 8/20 μs			19	V
Clamping Voltage	Vc	Ipp = 15A , tp = 8/20 μs			25	V
Junction Capacitance	Cj	Between I/O Pin and GND VR = 0V , f = 1MHz			100	pF



SPE1211 Single-Line ESD Protection Array

TYPICAL CHARACTERISTICS

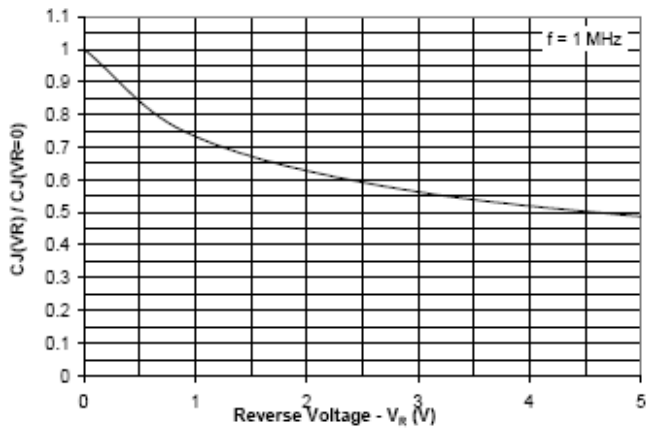

Fig 1 : Junction Capacitance V.S Reverse Voltage Applied

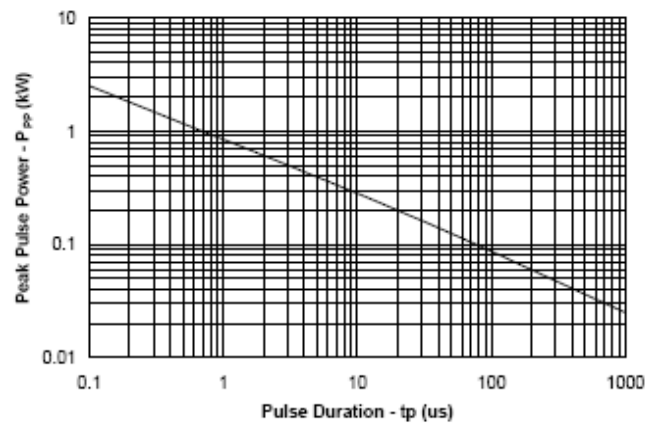

Fig 2 : Peak Plus Power V.S Exponential Plus Duration

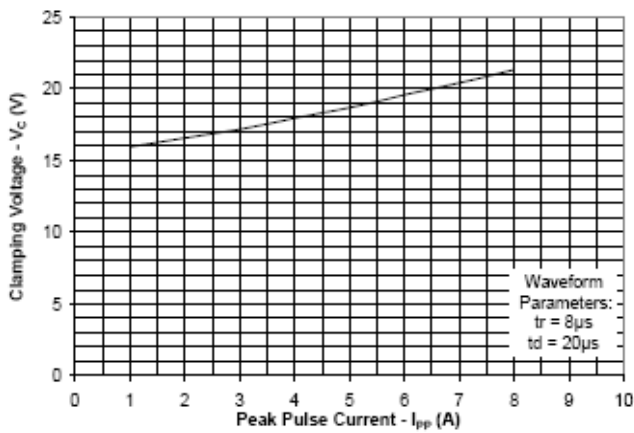

Fig 3 : Clamp Voltage V.S Peak Pulse Current

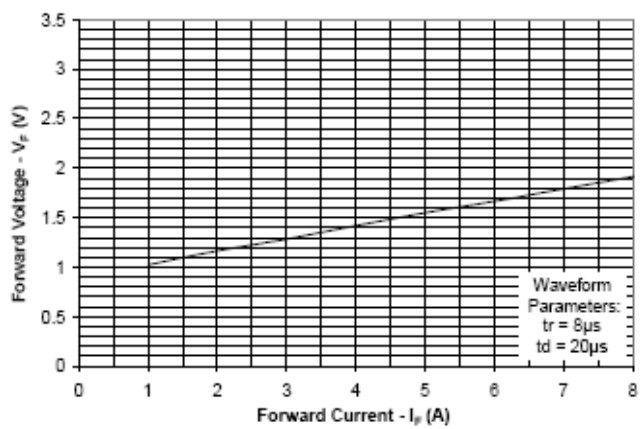

Fig 4 : Forward Voltage Drop V.S Peak Forward



SPE1211

Single-Line ESD Protection Array

APPLICATION NOTE

Device Connection Options Circuit Diagram

These TVS diodes are designed to protect one data, I/O, or power supply line. The device is unidirectional and may be used on lines where the signal polarity is above ground. The cathode band should be placed towards the line that is to be protected.

Circuit Board Layout Recommendations for Suppression of ESD.

Good circuit board layout is critical for the suppression of ESD induced transients. The following guidelines are recommended:

- ★ Place the TVS near the input terminals or connectors to restrict transient coupling.
- ★ Minimize the path length between the TVS and the protected line.
- ★ Minimize all conductive loops including power and ground loops.
- ★ The ESD transient return path to ground should be kept as short as possible.
- ★ Never run critical signals near board edges.
- ★ Use ground planes whenever possible.

Matte Tin Lead Finish

Matte tin has become the industry standard lead-free replacement for SnPb lead finishes. A matte tin finish is composed of 100% tin solder with large grains. Since the solder volume on the leads is small compared to the solder paste volume that is placed on the land pattern of the PCB, the reflow profile will be determined by the requirements of the solder paste. Therefore, these devices are compatible with both lead-free and SnPb assembly techniques. In addition, unlike other lead-free compositions, matte tin does not have any added alloys that can cause degradation of the solder joint.

Circuit Diagram

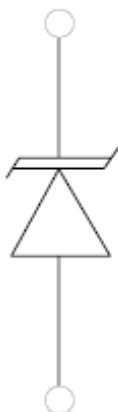



SPE1211

Single-Line ESD Protection Array

SOD-523 PACKAGE OUTLINE

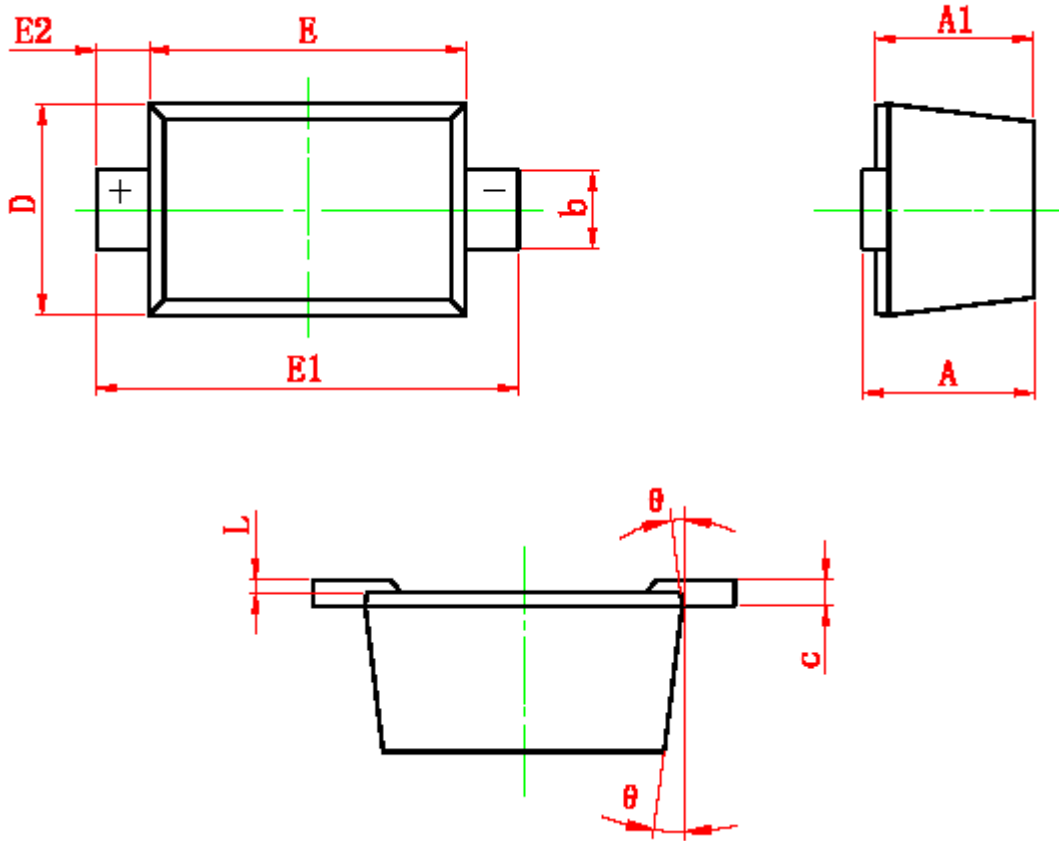

Symbol	Dimensions In Millimeters		Dimensions In Inches	
	Min	Max	Min	Max
A	0.510	0.770	0.020	0.031
A1	0.500	0.700	0.020	0.028
b	0.250	0.350	0.010	0.014
c	0.080	0.150	0.003	0.006
D	0.750	0.850	0.030	0.033
E	1.100	1.300	0.043	0.051
E1	1.500	1.700	0.059	0.067
E2	0.200 REF		0.008 REF	
L	0.010	0.070	0.001	0.003
θ	7° REF		7° REF	



SPE1211

Single-Line ESD Protection Array

Information provided is alleged to be exact and consistent. SYNC Power Corporation presumes no responsibility for the penalties of use of such information or for any violation of patents or other rights of third parties which may result from its use. No license is granted by allegation or otherwise under any patent or patent rights of SYNC Power Corporation. Conditions mentioned in this publication are subject to change without notice. This publication surpasses and replaces all information previously supplied. SYNC Power Corporation products are not authorized for use as critical components in life support devices or systems without express written approval of SYNC Power Corporation.

©The SYNC Power logo is a registered trademark of SYNC Power Corporation

©2004 SYNC Power Corporation – Printed in Taiwan – All Rights Reserved

SYNC Power Corporation

7F-2, No.3-1, Park Street

NanKang District (NKSP), Taipei, Taiwan, 115, R.O.C

Phone: 886-2-2655-8178

Fax: 886-2-2655-8468

©<http://www.syncpower.com>